

Bear Valley Water Sustainability Study



• December 2016 •

Recycled Water Facilities Planning Study

for the

Bear Valley Water Sustainability Project

Prepared for

Big Bear Area Regional Wastewater Agency

Big Bear City Community Services District

Big Bear Lake Department of Water and Power

Big Bear Municipal Water District

Prepared Under the Responsible Charge of:

Laine Carlson

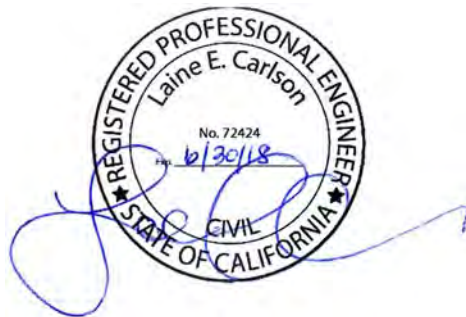

12/21/2016



ACKNOWLEDGEMENTS

The project team for this Recycled Water Facilities Planning Study (Study) for the Bear Valley Water Sustainability Project would like to acknowledge the valuable input and guidance received from the Board of Directors of the Big Bear Area Regional Wastewater Agency:

- David Caretto, Chairman representing the City of Big Bear Lake
- John Green, Vice Chairman representing Big Bear Area Community Services District
- Elizabeth Harris, Secretary representing San Bernardino County Service Area 53B
- Richard Herrick, Jr., Director representing City of Big Bear Lake
- Paul Terry, Director representing Big Bear Area Community Services District

The Study was funded in part by a Water Recycling Facilities Planning Grant from the California State Water Resources Control Board Water Recycling Funding Program.

The Study for the Bear Valley Water Sustainability Project was prepared by Water Systems Consulting, Inc. The primary authors are:

- Laine Carlson, P.E.
- Joshua Reynolds, M.S., P.E.
- Kaylie Ashton, E.I.T.
- Matt Rodrigues, M.S., P.E.
- Emily Iskin, M.S., E.I.T.

Water Systems Consulting, Inc. would like to acknowledge the significant contributions of the Project Team.



Steve Schindler
Fred Uhler
Jennifer McCullar
Jimmy Lona (Consultant)



Scott Heule, C.H.G.
Jerry Griffith



Reggie Lamson, P.E., L.S.
Steve Wilson
Jason Hall
Sierra Orr



Mike Stephenson

TABLE OF CONTENTS

Acknowledgements.....	i
Table of Contents	ii
List of Tables	vi
List of Figures	vii
List of Acronyms and Abbreviations	viii
Executive Summary.....	1
Introduction	1
Goals and Objectives.....	1
Alternatives Analysis.....	1
Recommended Alternatives	2
Funding and Financing	3
Conclusions	3
1 Introduction	1-1
1.1 Background and Purpose	1-1
1.2 Project Team	1-1
1.2.1 BBARWA.....	1-1
1.2.2 BBCCSD.....	1-2
1.2.3 BBLDWP	1-2
1.2.4 BBMWD.....	1-2
1.3 Goals and Objectives of Bear Valley Water Sustainability Project	1-3
1.4 Study Area Characteristics	1-4
1.4.1 Location.....	1-4
1.4.2 Population	1-4
1.4.3 Environmental Resources	1-4
1.4.4 Climate	1-8
2 Water Supplies and Characteristics	2-1
2.1 Big Bear Valley Groundwater Management Zone	2-1
2.2 Water Demand and Use Trends.....	2-3
2.3 Water Quality.....	2-4
2.4 Water Pricing	2-4

3	Wastewater Characteristics and Facilities	3-1
3.1	Existing and Projected Wastewater Flows.....	3-1
3.2	Existing Facilities and Discharge Requirements	3-3
3.2.1	Existing Discharge Requirements.....	3-5
3.2.2	BBARWA Operating Budget	3-8
3.2.3	Current Rate Schedule	3-8
3.2.4	Capital Improvement Plan	3-9
3.3	Treatment Requirements.....	3-9
3.3.1	Recycled Water Treatment Level for Groundwater Recharge.....	3-10
4	Recycled Water Market and Opportunities	4-1
4.1	Prior Market Analysis	4-1
4.2	Market Analysis Update	4-1
5	Project Alternatives Analysis.....	5-1
5.1	Alternatives Evaluated	5-1
5.1.1	Alternative 1: Disinfected Tertiary Landscape Irrigation	5-1
5.1.2	Alternative 2: Groundwater Recharge at Greenspot.....	5-7
5.1.3	Alternative 3: Groundwater Recharge at Sand Canyon	5-14
5.1.4	Alternative 4: Groundwater Recharge at Greenspot & Sand Canyon	5-20
5.2	Non-Recycled Water Alternative	5-27
5.3	No Project Alternative.....	5-27
5.4	Water Conservation/Reduction Analysis	5-28
5.5	Alternatives Analysis	5-31
5.5.1	Qualitative Evaluation Criteria	5-31
5.5.2	Quantitative Analysis Summary	5-31
5.5.3	Alternative Ranking Criteria and Scoring Results.....	5-32
5.5.4	Preferred Alternatives.....	5-32
6	Recommended Facilities Project Plan.....	6-1
6.1	Recycled Water Yield	6-1
6.2	Treatment Improvements.....	6-1
6.3	Recharge and Distribution Improvements.....	6-2
6.4	Cost Estimate	6-3
7	Implementation Plan	7-1

7.1	Next Steps For Implementation	7-1
7.2	Permitting Requirements.....	7-1
7.2.1	Tentative Water Recycling Requirements of the Santa Ana RWQCB	7-1
7.2.2	Infrastructure Permits.....	7-4
7.3	Environmental Documentation Requirements (CEQA)	7-4
7.4	Beneficiaries.....	7-5
7.5	Coordination and Governance	7-5
7.6	Public Outreach.....	7-5
8	Construction Financing Plan and Annual Operating Budget.....	8-1
8.1	Annual Operating Budget	8-1
8.2	Funding Opportunities	8-1
8.2.1	Grant and Loan Programs	8-2
9	Conclusions and Recommendations	9-1
10	References	10-1
Appendix A. WDR R7-2016-0026 and WDR R8-2005-004		
Appendix B. Recycled Water Overview		
Recycled Water Policy		
Santa Ana Region Basin Plan		
Anti-Degradation Policy		
Beneficial Uses		
Restricted and Unrestricted Irrigation Regulations		
CCR – Title 22		
Recycled Water Operational and On-site Requirements		
Indirect Potable Reuse via Groundwater Recharge		
CCR – Title 22		
Surface Water Augmentation and Direct Potable Reuse		
Summary of Permit Requirements		
Sustainable Groundwater Management Act (SGMA)		
Appendix C. Water Reuse Timeline and References		
Appendix D. Potential Recycled Water Users & Demands		
Appendix E. Technical and Financial Assumptions		
Technical Assumptions		

Financial Assumptions

Planning Level Cost Estimates

Markups and Contingencies

Unit Cost and Net Present Value

Appendix F. Treatment Upgrade Details

Alternative 1: Disinfected Tertiary Treatment

Alternative 2: Advanced Treatment Upgrades

Alternative 3: Satellite Advanced Treatment Plant

Alternative 4: Advanced Treatment Upgrades

Alternative Advanced Treatment Technologies

Appendix G. Cost Detail for Recycled Water Alternatives

Appendix H. Scoring Criteria Definitions

Appendix I. Fish Hatchery and Constructed Wetlands Concepts TM

Appendix J. Fort Erwin Tank Cost Evaluation Memorandum

Appendix L. Question & Answer Letter

LIST OF TABLES

Table 1-1. Historic and Projected Population for the Big Bear Valley	1-4
Table 2-1. Water Demand Projections for Bear Valley Water Agencies (AFY)	2-3
Table 2-2. BBLDWP Fixed Rates	2-5
Table 2-3. BBLDWP Tier Rates	2-5
Table 2-4. BBCCSD Base Rates	2-5
Table 2-5. BBCCSD Tier Rates.....	2-5
Table 3-1. BBARWA’s WWTP Treatment Process	3-3
Table 3-2. WDR Order No. R8-2016-0044 Discharge Points	3-5
Table 3-3. Discharge Limits for LV Site and Actual 2015 Effluent Quality	3-7
Table 3-4. 2015 BBARWA WWTP Effluent Quality – Annual Average	3-7
Table 3-5. BBARWA FY 2017 Operating Budget (12)	3-8
Table 3-6 BBARWA Rate Schedule (12).....	3-8
Table 3-7 BBARWA 5-year Capital Improvement Plan (12)	3-9
Table 3-8. Basin Plan Water Quality Objectives.....	3-10
Table 4-1. Potential Recycled Water Users and Demands.....	4-3
Table 5-1. Customers and Annual Average Demand by Segment	5-4
Table 5-2. Alternative 1 Facilities Summary	5-5
Table 5-3. Alternative 1 Pipeline Summary	5-6
Table 5-4. Unit Cost for Alternative 1	5-6
Table 5-5 Water Sources for Alternative 2 Groundwater Recharge.....	5-9
Table 5-6. Unit Cost for Alternative 2	5-13
Table 5-7 Water Sources for Alternative 3 Groundwater Recharge.....	5-16
Table 5-8. Unit Cost for Alternative 3	5-19
Table 5-9. Unit Cost for Alternative 4	5-24
Table 5-10 Cost Summary for Potential Refinements to Alternative 4	5-25
Table 5-11 Demand Management Measures Implemented by BBLDWP and BBCCSD	5-29
Table 5-12. Recycled Water Alternatives Quantitative Analysis Summary	5-31
Table 5-13. Alternative Ranking Criteria	5-32
Table 6-1. Summary of Alternative 4 Recycled Water Yield	6-1
Table 6-2. Treatment Capacity Summary for Alternative 4	6-2
Table 6-3. Alternative 4 Facilities Summary	6-2
Table 6-4. Cost Summary for Alternative 4.....	6-3
Table 6-5. Cost Summary Including 35% Grant for Alternative 4	6-3
Table 7-1. Tentative Water Recycling Requirements	7-3
Table 8-1. Estimated Project Annual Cost.....	8-1
Table 8-2. Eligible Funding Programs.....	8-1

LIST OF FIGURES

Figure 1-1. Water Agency Service Area	1-6
Figure 1-2. Sewer Collection Agency Service Area.....	1-7
Figure 1-3. Historical Precipitation in the Big Bear Valley (5).....	1-9
Figure 1-4. Historical Average Annual Temperatures in the Big Bear Valley (6)	1-9
Figure 2-1. Big Bear Valley Groundwater Basin and Subunits (9).....	2-2
Figure 2-2. Historic and Projected Water Demands	2-3
Figure 3-1. Seasonal Variation of BBARWA’s Wastewater Flows (2).....	3-1
Figure 3-2. Average Daily Flows by Month (2011-2015).....	3-2
Figure 3-3. BBARWA WWTP Process Flow Diagram	3-4
Figure 3-4. Existing Recycled Water Facilities.....	3-6
Figure 3-5. Treatment Level Considerations.....	3-12
Figure 4-1. Potential Recycled Water Users	4-4
Figure 4-2. Conceptual Hatchery Process Flow Diagram	4-5
Figure 4-3. Potential Recharge Areas Evaluated (13).....	4-10
Figure 5-1. Treatment Process Flow Diagram for Alternative 1	5-2
Figure 5-2. Alternative 1 Overview	5-3
Figure 5-3. Alternative 1 Potential Refinement Process Flow Diagram.....	5-7
Figure 5-4. Treatment Process Flow Diagram for Alternative 2	5-9
Figure 5-5. 22% Tertiary/78% Advanced Treatment Process Flow Diagram for Alternative 2.....	5-11
Figure 5-6. Alternative 2 Overview	5-12
Figure 5-7. Alternative 2 Potential Refinement Process Flow Diagram.....	5-14
Figure 5-8. Treatment Process Flow Diagram for Alternative 3	5-16
Figure 5-9. Treatment Process Flow Diagram Summarizing Blending Options for Alternative 3.....	5-17
Figure 5-10. Alternative 3 Overview	5-18
Figure 5-11 Treatment Process Flow Diagram for Alternative 4	5-21
Figure 5-12 22% Tertiary/78% Advanced Treatment Process Flow Diagram for Alternative 4.....	5-22
Figure 5-13 Alternative 4 Overview	5-23
Figure 5-14. Alternative Evaluation Results.....	5-33
Figure 6-1. Alternative 4 Overview	6-4
Figure 7-1. Permitting Process	7-3
Figure 10-1 Treatment Process Flow Diagram for Alternative 1	1

LIST OF ACRONYMS AND ABBREVIATIONS

The abbreviations included in this report are spelled out in the text the first time they are used and are subsequently identified by abbreviation only. A summary of the abbreviations used in this report is provided in this section.

Note: References are noted throughout the text of this report with the reference number in parentheses, i.e. (2). See Chapter 10 for the corresponding reference information.

Abbreviation	Definition
2015 UWMPs	2015 BBCCSD UWMP and 2015 BBLDWP UWMP
AFY	Acre-feet per Year
AOP	Advanced Oxidation Process
Basin	Big Bear Valley Groundwater Management Zone
Basin Plan	Santa Ana Region Basin Plan
BBARWA	Big Bear Area Regional Wastewater Agency
BBCCSD	Big Bear City Community Services District
BBLDWP	Big Bear Lake Department of Water and Power
BBMWD	Big Bear Municipal Water District
Bear Valley Mutual	Bear Valley Mutual Water District
bgs	Below ground surface
BMPTF	Basin Monitoring Program Task Force
BOD	Biochemical Oxygen Demand
CCF	Hundred Cubic Feet
CCR	California Code of Regulations
CDM	Camp Dresser & McKee, Inc.
CDPH	California Department of Public Health
CEC	California Energy Commission
CEC	Constituent of Emerging Concern
CEQA	California Environmental Quality Act
COD	Chemical Oxygen Demand
COE	U.S Army Corps of Engineers
Colorado WDR	Colorado River Basin RWQCB WDR Order No. R7-2016-0026
CSA 53	County of San Bernardino Service Area 53B
DAC	Disadvantaged Communities
DDW	Division of Drinking Water
DPR	Direct Potable Reuse
DWR	Department of Water Resources
EA	Environmental Assessment
EDU	Equivalent Dwelling Unit
EIR	Environmental Impact Report
EIS	Environmental Impact Statement
FAT	Full Advanced Treatment
ft	Feet
FTE	Full time equivalent
FY	Fiscal Year

Abbreviation	Definition
gpm	Gallons per minute
GRRP	Groundwater Replenishment Reuse Project
HGL	Hydraulic Grade Line
I/I	Infiltration and Inflow
in	Inches
IPR	Indirect Potable Reuse
IRWM	Integrated Regional Water Management
IS	Initial Study
Lake	Big Bear Lake
LV Site	Lucerne Valley
MBR	Membrane Bioreactor
MDD	Maximum Day Demand
MG	Million gallons
MGD	Million gallons per day
mL	milliliters
MMBTU	Million British Thermal Units
MPN	Most Probable Number
NEPA	National Environmental Policy Act
NPDES	National Pollutant Discharge Elimination System
NPR	Non-Potable Reuse
O&M	Operation and Maintenance
ORP	Oxidation-reduction Potential
PEIR	Program Environmental Impact Report
PFD	Process Flow Diagram
PHD	Peak Hour Demand
PPCP	Pharmaceuticals and Personal Care Products
Prop 1	2014 California Water Bond
RO	Reverse Osmosis
RW	Recycled Water
RWC	Recycled Water Concentration
RWMP	BBARWA's 2006 Recycled Water Master Plan
RW Policy	SWRCB Recycled Water Policy
RWQCB	Regional Water Quality Control Board
Santa Ana WDR	Santa Ana RWQCB WDR Order No. R-8-2005-0044
SAWPA	Santa Ana Watershed Project Authority
SB	Senate Bill
SGMA	Sustainable Groundwater Management Act
SMP	BBARWA's 2010 Sewer Master Plan
SNMP	Salt and Nutrient Management Plan
Study	Recycled Water Facilities Planning Study
SWRCB	California State Water Resources Control Board
TDS	Total Dissolved Solids
TIN	Total Inorganic Nitrogen
Title 22	California Code of Regulations, Title 22, Division 4, Chapter 3, Section 60301
TM	Technical Memorandum

Abbreviation	Definition
TOC	Total Organic Carbon
TSS	Total Suspended Solids
UF	Ultrafiltration
USBR	United States Bureau of Reclamation
USDA	United States Department of Agriculture
USEPA	United States Environmental Protection Agency
USGS	United States Geological Survey
UV	Ultraviolet
UV/AOP	Ultraviolet-Advanced Oxidation Process
UWMP	Urban Water Management Plan
Valley	Big Bear Valley
VSEP	Vibratory Shear-Enhanced Process
WDR	Waste Discharge and Produce/Use Water Recycling Requirements
WQO	Water Quality Objectives
WWTP	Wastewater Treatment Plant

EXECUTIVE SUMMARY

INTRODUCTION

Local groundwater provides the sole drinking water supply for the Big Bear Valley (Valley), located in the San Bernardino Mountains of San Bernardino County, California. Drought conditions and a long-term decline in precipitation trends have led local water and wastewater management agencies to investigate opportunities for supplemental supplies, which are extremely limited due to the high elevation and isolated location of the Valley. Currently, wastewater generated within the Valley is treated to secondary standards and discharged outside of the watershed to irrigate crops in the Lucerne Valley.

This Recycled Water Facilities Planning Study (Study) evaluates alternatives to develop a Bear Valley Water Sustainability Project with the goal to retain highly treated wastewater within the Valley for beneficial use. The Project Team for this Study is comprised of the Big Bear Area Regional Wastewater Agency (BBARWA), Big Bear City Community Services District (BCCSD), Big Bear Lake Department of Water and Power (BBLDWP), and Big Bear Municipal Water District (BBMWD). The Project Team recognizes that retaining recycled water in the watershed for beneficial use would significantly increase the sustainability of local water supplies and has partnered to jointly fund and prepare this Study. This Study was funded in part by a grant from the California State Water Resources Control Board (SWRCB) Water Recycling Funding Program.

GOALS AND OBJECTIVES

The Project Team established the following goals and objectives to guide the development of the Bear Valley Water Sustainability Project.

- Create a new and sustainable water supply
- Educate the community about water cycle, recycled water treatment process and water quality to gain public support
- Create a project that benefits all agencies involved
- Develop a cost-effective project to offset potable water demands
- Take advantage of current outside funding opportunities
- Explore viability of developing a fish hatchery to provide community benefits and potentially offset project costs
- Identify the costs of project components and the beneficiaries they will be allocated to

ALTERNATIVES ANALYSIS

This Study leverages prior recycled water planning efforts in the region and evaluates opportunities in the context of current and prospective future regulations. The following three recycled water project alternatives were developed for evaluation in this Study:

- Alternative 1: Provides disinfected tertiary recycled water for landscape irrigation and construction water use. Requires tertiary upgrades to the BBARWA Wastewater Treatment Plant (WWTP).

- Alternative 2: Provides advanced purified water for groundwater recharge at the Greenspot Recharge Site. Requires tertiary and advanced treatment upgrades to the BBARWA WWTP.
- Alternative 3: Provides advanced purified water for groundwater recharge at Sand Canyon Recharge Site. Assumes construction of a satellite treatment plant that provides tertiary and advanced treatment. Due to the unknown volume of dilution water available at this location, a range of treatment requirements were evaluated to identify bookend costs for this alternative.
- Alternative 4: Provides advanced purified water for a groundwater recharge at the Greenspot and Sand Canyon Sites to utilize all of the available recycled water in the Big Bear Valley. Requires tertiary and advanced treatment upgrades to the BBARWA WWTP.

Table ES-1 summarizes the costs and yield of the four alternatives.

Table ES-1. Cost and Yield Comparison for Alternatives Evaluated

Alternative	Alternative 1 Irrigation	Alternative 2 Greenspot	Alternative 3 Sand Canyon (Low Range)	Alternative 3 Sand Canyon (High Range)	Alternative 4 Greenspot and Sand Canyon
Total Capital Cost	\$3,257,000	\$44,533,000	\$23,255,000	\$24,315,000	\$69,700,000
Annual O&M Cost	\$65,000	\$1,539,000	\$1,174,000	\$1,259,000	\$2,726,000
Recycled Water Yield (AFY)	54	1,000	520	500	1,750
Unit Cost (\$/AF)	\$3,960	\$3,580	\$4,310	\$4,750	\$3,390
NPV	\$5,087,000	\$88,172,000	\$56,759,000	\$60,247,000	\$147,270,000

For comparison to the recycled water alternatives, the Study updated a prior analysis that estimated the cost for a non-recycled water alternative to convey imported State Water Project water to the Big Bear Valley from the Morongo Basin pipeline. The estimated unit cost for this imported water concept is \$5,630/AF. However, the Big Bear Agencies do not currently have supply contracts with a State Water Contractor and State Water Project water deliveries have declined in recent years and are subject to further reductions based on environmental and hydrologic factors. An imported water supply, if available, would be costlier than recycled water supplies and would not provide a sustainable or drought proof supply for the Valley.

RECOMMENDED ALTERNATIVES

The alternatives analysis concluded that opportunities for non-potable reuse for landscape irrigation in the Valley are limited and not cost effective due to relatively low demands and the extensive distribution system required to reach the customers.

Groundwater recharge was determined to be the most favorable alternative and the Sand Canyon and Greenspot Recharge Sites are both favorable for artificial recharge. Alternative 4 retains all of the available recycled water in the Valley and has the lowest unit cost among all the alternatives considered.

A further discussion of the recommended project is included in Chapter 6.

FUNDING AND FINANCING

The cost estimate for the recommended Alternative 4 is summarized in Table ES-2.

Table ES-2. Cost Summary for Alternative 4

Alternative	Capital Cost	O & M Cost	Recycled Water Yield, AF	Unit Cost, \$/AF
Alternative 4: Greenspot & Sand Canyon Recharge	\$69,700,000	\$2,726,000	1,750	\$3,390

The project could be funded through a combination of grants and low interest loans. The SWRCB Water Recycling Funding Program received funding from the 2014 California Water Bond (Prop 1) and is currently offering grant funding for water recycling projects. This grant program, which is described in more detail in Section 8.2.1, is offering 35% grants, with a maximum grant amount of \$15,000,000. To illustrate the benefits of this grant program, Table ES-3 summarizes the local portion of the project costs if a 35% grant is received to reduce the local capital contribution.

Table ES-3. Cost Summary with 35% Grant for Alternative 4

Alternative	Capital Cost	O & M Cost	Recycled Water Yield, AF	Unit Cost, \$/AF
Alternative 4: Greenspot & Sand Canyon Recharge	\$45,305,000	\$2,726,000	1,750	\$2,750

There may be opportunities to leverage other grant funding programs, such as the United States Department of Agriculture (USDA) Rural Development Water and Environment Program, to further reduce the portion of project costs that must be funded locally.

CONCLUSIONS

The implementation of a Bear Valley Water Sustainability Project that retains highly treated water in the Valley for beneficial use would provide a sustainable and drought proof source of supply that would support current and future residents and businesses long into the future. However, even with taking advantage of current funding programs, such a project would represent a significant investment for the community. The costs and long term benefits to the community should be carefully considered when determining the timing for implementation of the Bear Valley Water Sustainability Project.

1 INTRODUCTION

1.1 BACKGROUND AND PURPOSE

The Big Bear Valley (Valley) is located in the San Bernardino Mountains of San Bernardino County, California. The area includes approximately 135 square miles within a 12-mile long valley surrounded by mountain ridges and rugged slopes. Land surface elevations range from 6,000 to 9,900 ft and the area is entirely surrounded by the San Bernardino National Forest. Big Bear Lake lies within the Valley and has a surface area of approximately 10 square miles and 23 miles of shoreline.

Local groundwater provides the sole drinking water supply for the Valley. Drought conditions and a long-term decline in precipitation trends have led the local water agencies to investigate opportunities for supplemental supplies, which are extremely limited due to its isolated location at the top of the watershed.

Currently, wastewater generated within the Valley undergoes preliminary and secondary treatment and is discharged outside of the watershed to irrigate alfalfa fields in the Lucerne Valley located approximately 20 miles north of the Valley. This Study evaluates alternatives to develop a Bear Valley Water Sustainability Project with the goal to retain highly treated wastewater within the Valley for beneficial use. By doing so, this will provide a supplemental and drought proof source of water for current and future Valley residents and businesses. This Study leverages prior recycled water planning efforts in the region and evaluates opportunities in the context of current and prospective future regulations. This Study was funded in part by a grant from the California State Water Resources Control Board (SWRCB) Water Recycling Funding Program.

1.2 PROJECT TEAM

The Project Team is comprised of the Big Bear Area Regional Wastewater Agency (BBARWA), Big Bear City Community Services District (BCCSD), Big Bear Lake Department of Water and Power (BBLDWP), and Big Bear Municipal Water District (BBMWD). The Project Team recognizes that retaining recycled water in the watershed for beneficial use would significantly increase the sustainability of local water supplies and has partnered to jointly fund and prepare this Study. The following sections provide a brief introduction to each agency.

1.2.1 BBARWA

BBARWA was formed in March 1974 to conduct a study to develop a plan for wastewater management within the greater Valley region. A subsequent 1975 Wastewater Facilities Plan was prepared which identified the need to provide centralized, environmentally friendly wastewater conveyance, treatment and disposal for the BBARWA service area.

The BBARWA service area includes the entire Big Bear Valley (79,000 acres) and is served by three separate collection systems: the City of Big Bear Lake, representing approximately 47% of the connections, and the BBCCSD, representing approximately 48% of the connections, and the County of San Bernardino Service Area 53B (CSA 53), representing approximately 5% of the connections. Each of these member agencies maintains and operates its own wastewater collection system, and delivers wastewater to BBARWA's interceptor system for transport to the BBARWA Regional Wastewater Treatment Plant (WWTP).

1.2.2 BBCCSD

BBCCSD was created in 1966 by a formation and consolidation election and initially provided solid waste collection, fire protection and street lighting services. In 1967, the former Big Bear Mutual Service Company voted to relinquish ownership and operation of their water system to BBCCSD. Currently BBCCSD's services include water, wastewater collection, fire protection & emergency medical services, solid waste collection, and street lighting services. BBCCSD's water service area includes Big Bear City and portions of San Bernardino County. BBCCSD's wastewater collection area includes Big Bear City and portions unincorporated communities such as Sugarloaf, Erwin Lake, Whispering Forest, and Moonridge.

1.2.3 BBLDWP

BBLDWP was formed in 1989 with the purchase of the retail water system from Southern California Water Company and currently provides water service to the City of Big Bear Lake, located along the south side of Big Bear Lake, as well as the unincorporated communities of Fawnskin, which lies to the north of the lake, and Sugarloaf, Erwin Lake and Lake William areas, which lie on the east side of the Valley.

The City of Big Bear Lake provides wastewater collection services within the city, while BBCCSD and CSA 53B provide wastewater collection services within BBLDWP's water service area that lies outside the city limits.

1.2.4 BBMWD

BBMWD, formed in 1964, is an independent special district that is responsible for the overall management of Big Bear Lake. The primary responsibilities of BBMWD are:

- Stabilization of the level of Big Bear Lake by managing the amount of water released to Bear Valley Mutual
- Watershed/water quality management
- Recreation management
- Wildlife habitat preservation and enhancement
- Bear Valley Dam and Reservoir maintenance

The Big Bear Dam was originally constructed to provide water storage for Bear Valley Mutual Water Company (Bear Valley Mutual), which was formed in 1903 by the citrus growers of the Redlands/Highland area to ensure water supply for irrigation needs. The historic operation of the Big Bear Lake (Lake) as an irrigation reservoir resulted in drastic fluctuations in lake levels, which conflicted with the goals of BBMWD and the community of Big Bear Valley. A legal conflict over the water rights and management of the lake was ultimately settled out of court through the 1977 Judgement. Under the terms of this judgement, BBMWD purchased the lake bottom, Bear Valley Dam, and the right to utilize and manage the surface of Big Bear Lake from Bear Valley Mutual. Bear Valley Mutual retained a storage right and ownership of all water inflow into Lake (1).

The 1977 Judgment allows BBMWD to maintain a higher water level in the lake by delivering water to Bear Valley Mutual from an alternate source of water. This alternate source of water, referred to as in-lieu water, comes mainly from the State Water Project through a contract with San Bernardino Valley Municipal Water District, a State Water Contractor. If BBMWD does not wish to purchase in-lieu water, it must deliver water from the Lake to Bear Valley Mutual to meet their water demands.

BBMWD currently has a contract with the Big Bear Mountain Resorts, allowing the withdrawal of an allocated amount of water from the Lake to use for snow making purposes. Currently, Big Bear Mountain Resort is authorized to withdraw a maximum of 11,000 acre-feet (AF) of water from the Lake over a 10-year rolling period, not exceeding 1,300 AF in any single year. It is calculated that half of the water withdrawn from the lake is returned as runoff (1). Note that Mammoth Resorts recently purchased the Big Bear Mountain Resorts and potential future changes in their operations may affect water needs and wastewater generation from the resorts.

1.3 GOALS AND OBJECTIVES OF BEAR VALLEY WATER SUSTAINABILITY PROJECT

Members of the Project Team identified goals and objectives for the Bear Valley Water Sustainability Project through discussions with potential stakeholders, insight gained from prior recycled water planning efforts, and feedback from their respective boards. Based on the information gathered through this collaborative process, the Project Team established the following goals and objectives to guide the development of the Bear Valley Water Sustainability Project.

- Create a new and sustainable water supply
- Educate the community about the hydrologic cycle, recycled water treatment processes, and water quality objectives to gain public support for the project
- Create a project that benefits all agencies involved
- Develop a cost-effective project to offset potable water demands
- Take advantage of current outside funding opportunities
- Explore viability of developing a fish hatchery to provide community benefits and potentially offset project costs
- Identify the costs of project components and the beneficiaries they will be allocated to

1.4 STUDY AREA CHARACTERISTICS

1.4.1 Location

The study area for this Study includes the entire Big Bear Valley, spanning the collective service areas of the Project Team. The water service areas in the study area are shown in Figure 1-1 and the sewer collection service areas are shown in Figure 1-2.

1.4.2 Population

The 2015 population for the Big Bear Valley was estimated to be approximately 23,000 based on the BBCCSD 2015 Urban Water Management Plan (UWMP) and BBLDWP 2015 UWMP (collectively the 2015 UWMPs). The area is primarily residential with some commercial, and experiences an influx of part-time population and vacationers enjoying the summer and winter recreational facilities within the valley. Due to the recreational nature of the Big Bear City and the City of Big Bear Lake economies, occupancy within the valley fluctuates seasonally, typically peaking in July and at the lowest level during the winter. Population and recreation fluctuations are anticipated to remain constant relative to previous years. The City of Big Bear Lake’s growth rate is estimated to be 0.7% and Big Bear City’s growth rate is 0.9%. Table 1-1 presents the historic and projected full-time resident population for the Big Bear Valley.

Table 1-1. Historic and Projected Population for the Big Bear Valley

Water Service Area	2010	2015	2020	2025	2030	2035
BBLDWP	9,404	11,382	11,786	12,204	12,637	13,086
BBCCSD	11,503	11,528	11,667	12,244	12,849	13,485
Total	20,907	22,910	23,453	24,448	25,486	26,571
Notes:						
1. Values were obtained from the 2015 BBLDWP UWMP and the 2015 BBCCSD UWMP.						
2. Values are representative of full-time residents.						
3. CSA 53B represents approximately 5% of BBARWA’s sewer connections. (2) It is assumed that BBARWA’s CSA 53B customers (in Fawnskin) are included in the BBLDWP Water Service Area population estimate.						

1.4.3 Environmental Resources

In 2005, BBARWA prepared a Program Environmental Impact Report (EIR) for the Recycled Water Master Plan. (3) The EIR describes the environmental resources in the area, which are summarized in the following subsections.

1.4.3.1 Geography

The Valley is located in the San Bernardino Mountains in San Bernardino County, California. The Valley includes approximately 135 square miles of unincorporated area surrounding Big Bear Lake and is entirely surrounded by the San Bernardino National Forest. The valley’s land surfaces range from 7,000 to 9,900 ft and is surrounded by mountain ridges and rugged slopes. Big Bear Lake, at an elevation of 6,740 ft, has a surface area of 10 square miles and 23 miles of shoreline.

1.4.3.2 **Water Resources and Wetlands**

Groundwater is the current water resource in the Valley. The Big Bear Valley Groundwater Basin contains 16 subunits as shown in Figure 2-1. The study area contains a variety of wetlands and aquatic habitats, a number of streams with riparian habitat and typical wetlands along the lake.

1.4.3.3 **Agricultural**

The Valley does not contain any commercial agricultural operation. The San Bernardino County General Plan (1996) discourages agricultural land use in mountain regions.

1.4.3.4 **Cultural and Historical Properties**

Within the Valley there are several designated California Historical Landmarks and County Points of Historic Interest including the Old Big Bear Dam and Baldwin Lake. The area was occupied by the Serrano Native Americans until 1861. Smaller villages were located near water sources like small creeks with larger villages situated at Pan Hot Springs and in the Baldwin Lake area. No recorded Native American sites have been identified in the area.

1.4.3.5 **Biological Resources**

There are many biological resources within the Valley including forest, streams, lakes, meadows, unique animals, and plants that are protected by numerous federal and state agencies and regulations. Some of the major protected animals include the Bald Eagle, Southern Rubber Boa, Southwestern Willow Flycatcher, Unarmored Threespine Stickleback, and the San Bernardino Flying Squirrel. A more detailed list of the protected animals and plants is included in the EIR.

1.4.3.6 **Air Quality**

The Valley lies just within the South Coast Air Basin, which is one of the major air management basins in California. Since the Valley is not located near the Cajon Pass and Banning Pass, which transport pollution out of the basin, the Valley is believed to have better air quality than elsewhere in the basin, during winter and summer. (3)

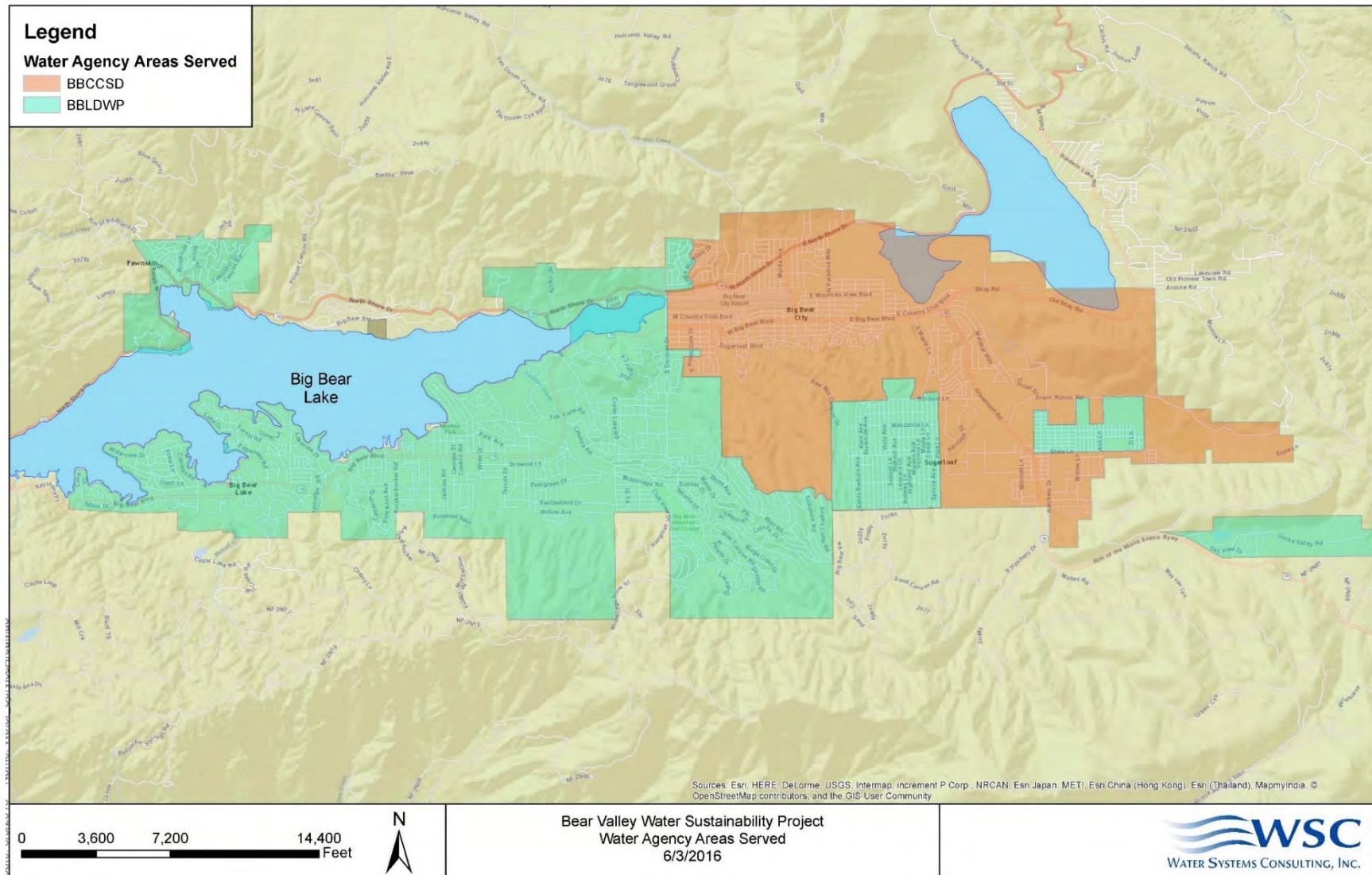

Figure 1-1. Water Agency Service Area

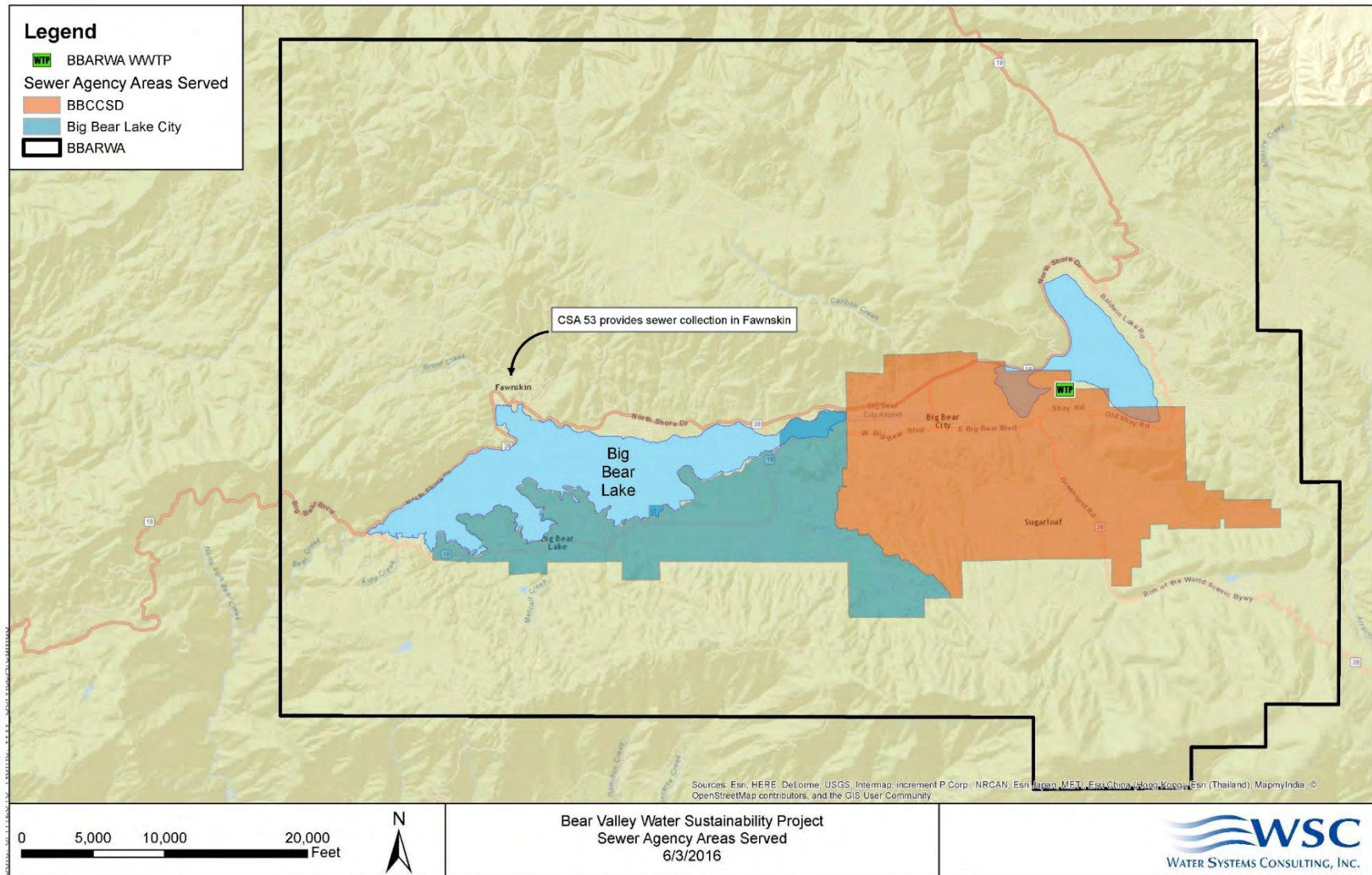

Figure 1-2. Sewer Collection Agency Service Area

1.4.4 Climate

The Valley climate is a semi-arid, Mediterranean environment with cold winters, warm summers, and moderate rainfall. The average monthly temperature ranges from about 32 to 62 degrees Fahrenheit (°F), with an average annual temperature of 47°F. Most of the precipitation typically occurs from November through April. Records show that the average monthly precipitation ranges from about 0.1 in to 7.10 in. The historical precipitation and temperatures are presented in Figure 1-3 and Figure 1-4.

As shown, precipitation trends are declining and temperature trends are increasing. These long term trends can have an impact on the sustainability of local water supplies in the Valley. The potential impacts include (4):

- Reduction of snowpack, which is a significant source of water in the Valley
- Increase in intensity and frequency of extreme weather events
- Effects on groundwater recharge during droughts
- General decline in ecosystem health and function
- Changes to demand level and patterns due to increasing temperatures

These factors reinforce the importance of securing additional sustainable water supplies for the region.

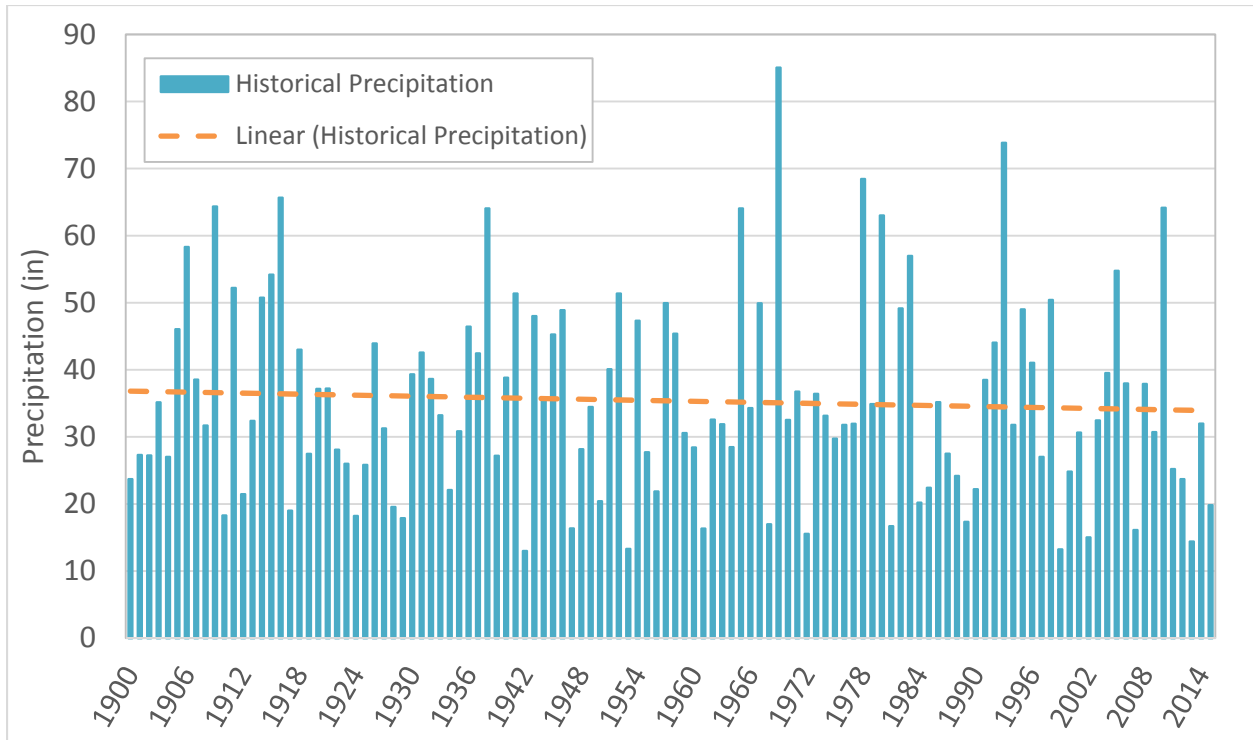

Figure 1-3. Historical Precipitation in the Big Bear Valley (5)

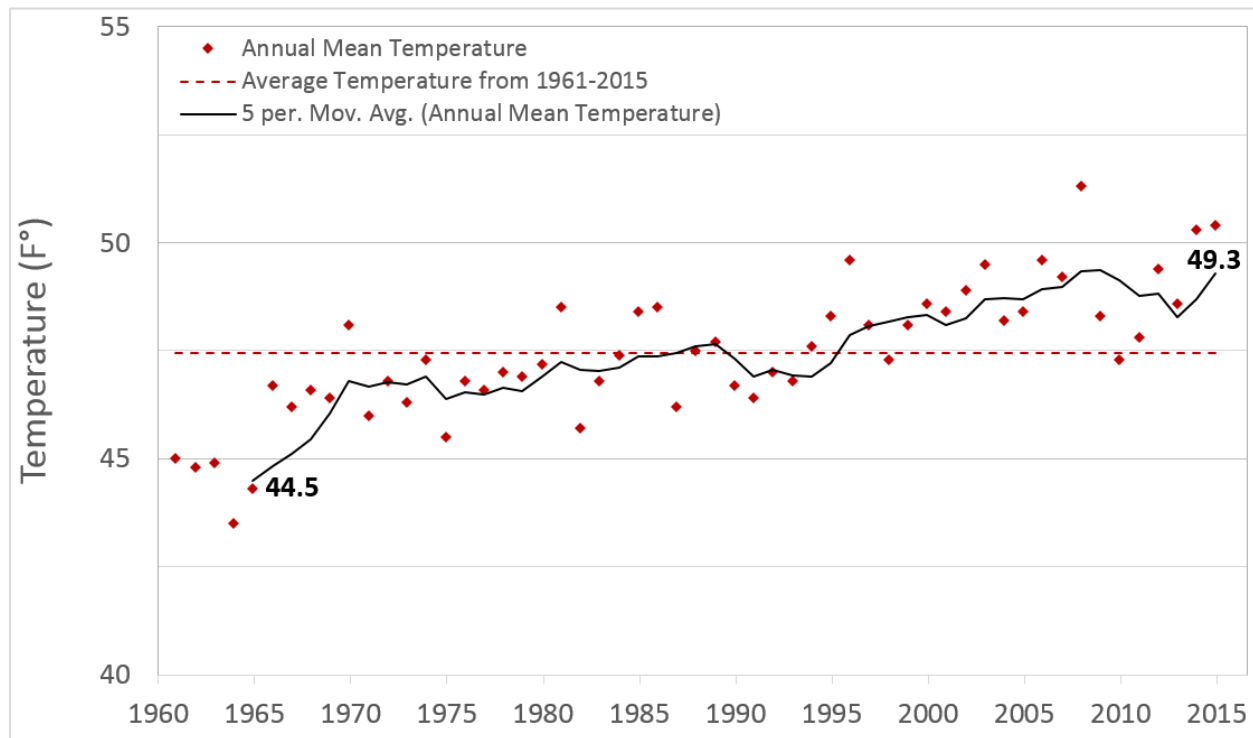

Figure 1-4. Historical Average Annual Temperatures in the Big Bear Valley (6)

2 WATER SUPPLIES AND CHARACTERISTICS

This section provides a brief overview of current water supplies in the Big Bear Valley to provide context for the development of recycled water supplies. Currently, the sole source of water supply in the Valley is groundwater from the Big Bear Valley Groundwater Management Zone (Basin). Surface water and imported water are currently not used by the water agencies. Additional information about water supplies can be found in the 2015 UWMPs.

2.1 BIG BEAR VALLEY GROUNDWATER MANAGEMENT ZONE

The Basin lies in the northeastern portion of the Santa Ana River Watershed and is currently not adjudicated. The Basin is roughly 14 miles long from east to west and 7 miles wide from north to south. Big Bear Lake and Baldwin Lake are located in the middle of the Basin. Surface drainage within the Basin flows to one of the two lakes, mostly Big Bear Lake. Big Bear Lake empties on the west into Bear Creek, which is a tributary to the Santa Ana River. The Basin is primarily composed of unconsolidated alluvium and is divided into upper, middle and lower aquifers; where the upper and middle aquifers are the primary producers. Based on the drainage system, the Basin is divided into 16 hydrologic subunits with the main tributaries including Grout Creek, Van Dusen Canyon, Sawmill Canyon, Sand Canyon, Knickerbocker Creek, Metcalf Creek, and North Creek. The Basin and subunits are presented in Figure 2-1.

The Basin is recharged from percolation of precipitation, runoff and underflow from fracture rock formations; with groundwater levels that generally correlate with annual fluctuations of precipitation. Storage capacity of the Basin is estimated by DWR at 42,000 AFY with the maximum perennial yield estimated at 4,800 AFY (7). In addition to the municipal water purveyors, there are numerous private wells throughout the Basin serving properties that are not connected to a public water system.

BBLDWP and BBCCSD manage and monitor the Basin. Through the Groundwater Monitoring and Management Plan, BBLDWP manages the Basin by conducting monthly monitoring of 18 non-pumping monitoring wells and approximately 40 production wells, bi-annual Technical Review Team meetings, and has established conservation levels based on groundwater levels and trends in key wells. BBCCSD also manages the groundwater level and water quality by conducting monthly monitoring in 11 non-pumping monitoring wells and 13 production wells, monthly monitoring of surface flow in Van Dusen Creek, Shay Creek and Green Canyon Creek, and has established action criteria for average groundwater levels across the BBCCSD service area that are tied to conservation stages and measures. Conservation efforts have helped to keep annual groundwater production less than the perennial yield of the Basin. The Basin is not currently identified by DWR to be in overdraft condition. (4) (8)

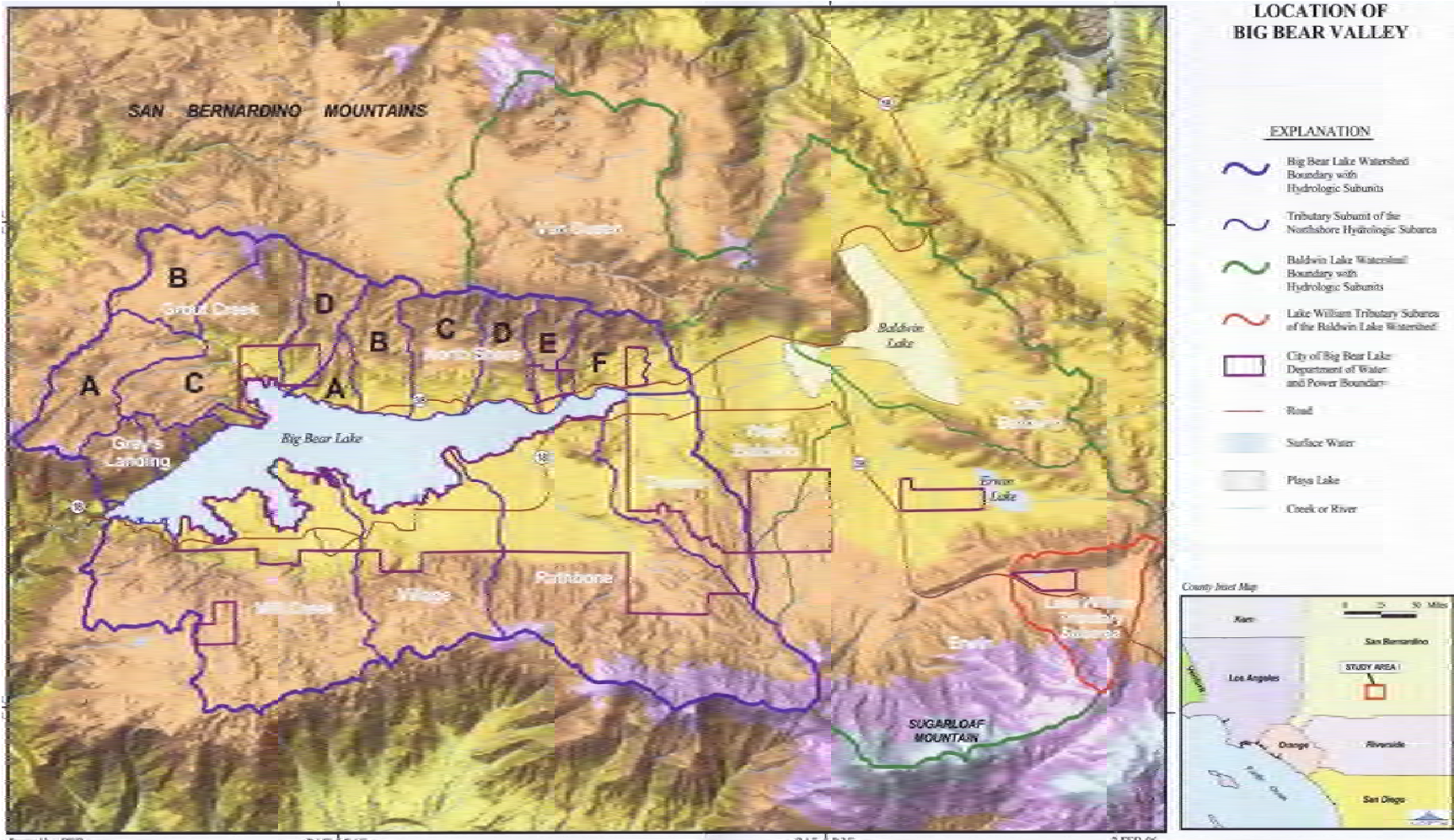

Figure 2-1. Big Bear Valley Groundwater Basin and Subunits (9)

2.2 WATER DEMAND AND USE TRENDS

The BBLDWP service area is primarily residential with commercial accounts making up 5% and industrial making up less than 1% of the total accounts. BBCCSD serves only residential accounts. The projected water demands for BBLDWP and BBCCSD area are presented in Table 2-1. The historical and projected water demands for each water agency along with the total demands for the agencies are presented in Figure 2-2. These estimates do not include water used from private wells, which was estimated to be approximately 169 AFY in the BBLWDP 2006 Water Master Plan (7).

Table 2-1. Water Demand Projections for Bear Valley Water Agencies (AFY)

Water Agency	2015	2020	2025	2030	2035
BBLDWP¹	2,095	2,169	2,246	2,326	2,408
BBCCSD²	940	1,163	1,220	1,281	1,344
Total	3,035	3,332	3,466	3,607	3,752

Note:
 1. BBLDWP 2015 UWMP
 2. BBCCSD 2015 UWMP

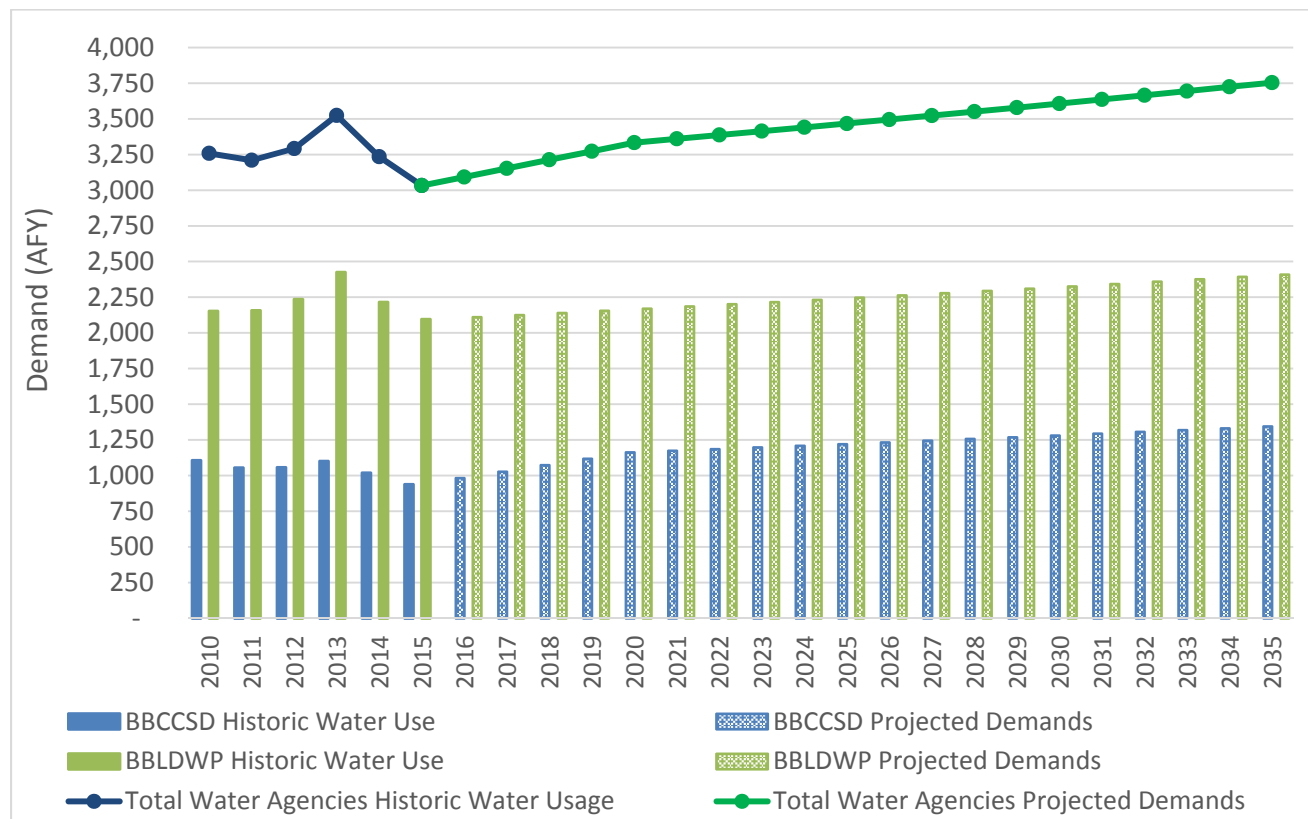

Figure 2-2. Historic and Projected Water Demands

2.3 WATER QUALITY

As stated in the 2015 UWMPs, the Basin generally contains high water quality. The BBLDWP 2015 UWMP states that the eastern portion of the Basin does contain elevated fluoride levels and there are other problem constituents including manganese, uranium, and arsenic. Water treatment plants, occasional blending projects and wells being shut down address these problems; however, these potential water quality issues are not anticipated to disrupt groundwater supply.

Total dissolved solids (TDS) concentrations in the Big Bear Valley groundwater supplies range from 140 to 450 mg/l with an average of 250 mg/l in the Big Bear Valley (10) (11). For recycled water projects, the concentration of TDS (or salts) in the water are of importance because high TDS RW can impact beneficial uses as well as treatment costs. For groundwater recharge applications, elevated TDS levels may be prohibited in order to protect the groundwater quality. In this case, excess salts would need to be removed, resulting in higher costs for FAT process construction and operation, as well as the brine management system. In RW irrigation applications, elevated TDS levels in the RW can be harmful to landscape plants or turf due to salt buildup in the root zone. Salt buildup in landscape applications can often be managed and is not likely to require additional treatment.

2.4 WATER PRICING

BBLDWP and BBCCSD have similar water rate structures comprised of 2 components: rates per hundred cubic foot (CCF) to account for variable costs and water service charges to account for fixed costs. Both BBLDWP and BBCCSD's billing cycles are bi-monthly. The current rate structures are shown in Table 2-2 and Table 2-3 for BBLDWP and Table 2-4 and Table 2-5 for BBCCSD.

Table 2-2. BBLDWP Fixed Rates

Fixed Rates	Residential Service	Commercial Service
Bimonthly service charge, 5/8" meters	\$87.66	\$51.92
Bimonthly service charge, 1" meters	\$156.92	\$86.55
Service charge base rate	0-8 ccf	0-4 ccf
Note:		
1. Rates as of May 2016 available at http://www.bbldwp.com/		

Table 2-3. BBLDWP Tier Rates

Level	Water Amount (ccf)	Rate (\$/ccf)
Residential Service Rates		
Tier 1	9-24	\$2.64
Tier 2	25-40	\$3.67
Tier 3	41-60	\$5.47
Tier 4	61-100	\$9.31
Tier 5	101+	\$12.53
Commercial Service Rates		
Tier 1	5+	\$3.79
Note:		
1. Rates as of May 2016 available at http://www.bbldwp.com/		

Table 2-4. BBCCSD Base Rates

Meter Size	Base Rate
5/8", 3/4", 1"	\$63.43
1 1/2"	\$126.85
2"	\$202.96
3"	\$380.56
4"	\$634.26
6"	\$1268.52
Note:	
1. Rates as of May 2016 available at http://www.bbccsd.org/	

Table 2-5. BBCCSD Tier Rates

Meter Size	Tier 1 (hcf)	Tier 2 (hcf)	Tier 3 (hcf)
5/8", 3/4", 1"	0-12	13-38	Over 38
1 1/2"	0-24	25-48	Over 48
2"	0-38	39-77	Over 77
3"	0-72	73-144	Over 144
4"	0-120	121-240	Over 240
6"	0-240	241-480	Over 480
Tier Cost (\$/hcf)	\$1.63	\$1.75	\$2.43
Note:			
1. Rates as of May 2016 available at http://www.bbccsd.org/			

3 WASTEWATER CHARACTERISTICS AND FACILITIES

BBARWA owns and operates a 4.9 million gallons per day (MGD) capacity WWTP located just south of Baldwin Lake on the east side of the Valley. The WWTP currently treats approximately 1.76 MGD of municipal wastewater collected from BBCCSD, the City of Big Bear Lake and the CSA 53 in the community of Fawnskin.

3.1 EXISTING AND PROJECTED WASTEWATER FLOWS

The influent flows to BBARWA’s WWTP are comprised of three components:

- Flow from full-time residential homes
- Flows due to tourism, commercial activities and part-time residential homes
- Flows from Infiltration and Inflow (I/I) due to precipitation

These components create a seasonal variation in the wastewater flows treated at the plant. Figure 3-1 illustrates the monthly variation of the flows due to each wastewater flow components. The monthly base flows correspond to flows from full-time residents; while the monthly other flows are comprised of flows from seasonal residents or tourism. Based on full-time residency rates from BBCCSD and BBLDWP and the number of full-time dwelling units reported by Bear Valley Electric, BBARWA’s 2010 Sewer Master Plan (2010 SMP) estimated that the full-time residential rate is 38% (2).

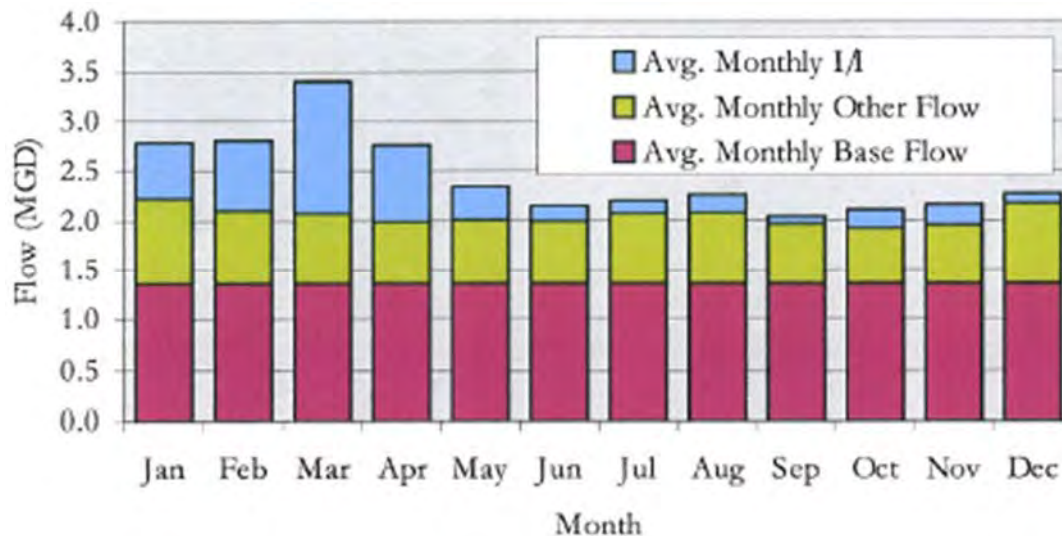

Figure 3-1. Seasonal Variation of BBARWA’s Wastewater Flows (2)

The tourism season is largely concentrated in the months of December through April due the local ski resorts. The months of June and July also see a slight rise in tourism due to Lake recreation activities. Average daily flows and the seasonal variation from 2011 to 2015 are shown in Figure 3-2. The average daily flow for this time period is approximately 2.1 MGD and the maximum month flow is 5.5 MGD. In 2015, the annual average effluent flow was 1.76 MGD and the maximum month flow was 2.32 MGD in January 2015. The highest daily influent flow of 3.30 MGD occurred on January 2, 2015.

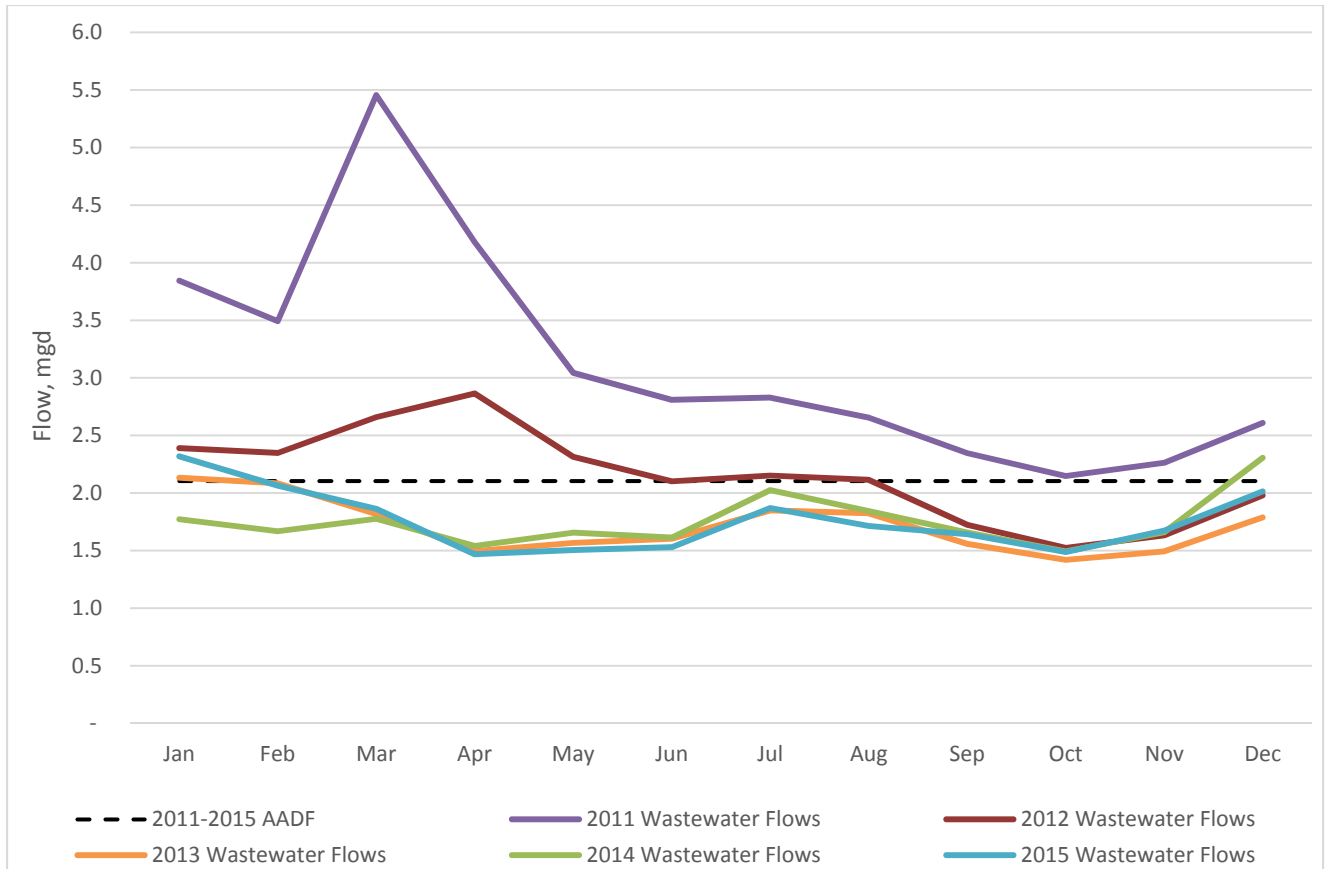

Figure 3-2. Average Daily Flows by Month (2011-2015)

The 2010 SMP estimated the future sewer flows based on future population and equivalent dwelling unit (EDU) projections utilizing the constant sewer load index of 172 gallons per day for full time residential EDUs. For the purposes of this Study, an EDU is defined as the amount of wastewater flow generated by one single-family residence. The 2010 SMP assumes the full-time EDUs will increase at an annual rate of 0.8% over a 20-year period based on a long-term average.

Assuming the full-time residence rate remains at 38% and that I/I will be consistent with the previous average, the 2010 SMP projects that the average annual sewer flows will increase from 2.1 MGD to 2.73 MGD by 2030. If the full-time resident sewer component factor grows to 100 %, the plant could see flows up to 5.27 MGD in 2030.

3.2 EXISTING FACILITIES AND DISCHARGE REQUIREMENTS

BBARWA’s WWTP is located on a 93.5-acre lot. The WWTP process components occupy 11.2 acres and the remaining 82.3 acres include storage ponds and evaporation ponds. Influent flows are conveyed through three BBARWA operated sewer mains and lift stations to the plant.

- Lake Interceptor Line: Serves the City of Big Bear Lake’s sewer system and uses the Lake Pump Station to convey flows to the WWTP
- North Shore Interceptor: Serves SBC 53B sewer system and conveys flows to the BBARWA Trunk Line
- BBARWA Trunk Line: Serves BBCCSD’s sewer system and conveys flows from the North Shore Interceptor. Pump Station #1, Pump Station #2 and Pump Station #3 are used to pump flows to the WWTP.

The WWTP currently provides preliminary and secondary treatment. Table 3-1 summarizes the WWTP’s treatment processes and the process flow diagram is depicted in Figure 3-3.

Table 3-1. BBARWA’s WWTP Treatment Process

Treatment Process ¹	Description
Preliminary Treatment	Consists of bar screens, grit removal and disposal of solids
Secondary Biological Treatment	Consists of oxidation ditches which uses mechanical aeration to achieve organic material stabilization, nutrient removal and pathogen reduction. Solids production is minimized by the Cannibal® Solids Reduction System, through use of a side-stream interchange bioreactor with aeration controlled by the ORP level.
Secondary Sedimentation Treatment	Consists of clarifiers to settle solids. Waste activated sludge (WAS) is pumped to a dissolved air floatation (DAF) system
WAS Thickening	Consists of a DAF system that skims sludge for sludge dewatering. Filtrate is returned to oxidation ditches.
Sludge Dewatering²	Sludge is dewatered using a belt press and a heated drying facility. The drying facility consists of a covered building where floors are heated by the WWTP’s generator exhaust. This allows for sludge to be dewatered throughout the year instead of summer only. The dry solids are hauled to a composting facility in Redlands.
Notes:	
1. Descriptions obtained from the 2005 BBARWA Recycled Water Master Plan unless otherwise noted.	
2. Obtained from BBARWA’s website - http://bbarwa.org	

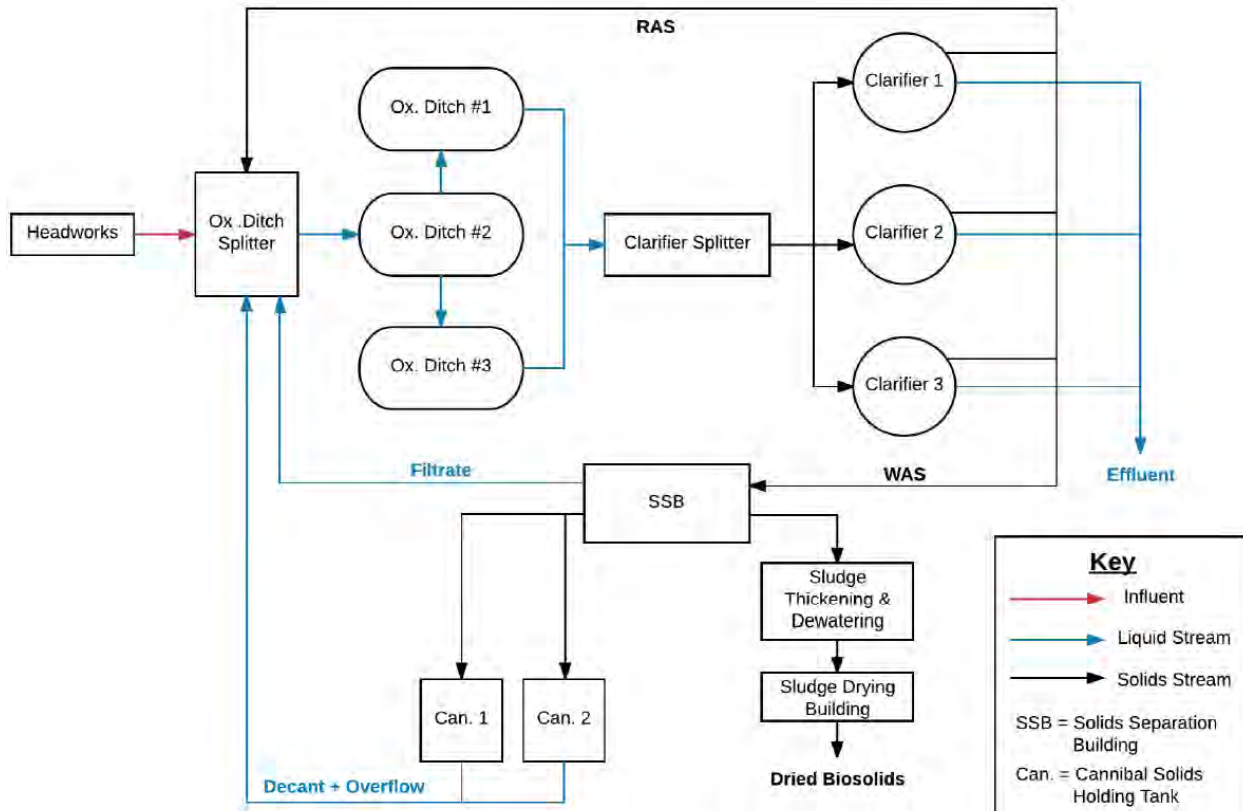

Figure 3-3. BBARWA WWTP Process Flow Diagram

BBARWA recently completed several upgrades to the sludge dewatering process. Heat exchangers were installed on the existing generator to capture waste heat; hot water from the heat exchangers is used to heat the floor of the lined drying bed. A metal building was also constructed to cover the lined drying bed that measures 315-ft in length and 60-ft in width so that the dewatering process could operate year round.

BBARWA’s WWTP generates its own electricity using three natural gas generators that can be run in parallel: two 250 KW Cummins generators and one Waukesha generator with a rating of 600 kilowatts for a total generating capacity of 1100 kilowatts. BBARWA only generates the energy needed to operate the WWTP and Administration Building and typical generation is in the range of 225,000 - 350,000 kilowatt-hours (kW-hr) per month. In 2015, total energy generation was 3,100,216 kW-hr. Natural gas consumption was 43,544 million British Thermal Units (MMBTU) or 435,440 therms. BBARWA also has a connection to the Bear Valley Electric utility system that is used to run its pumping stations and can serve as an emergency backup power supply for the WWTP.

3.2.1 Existing Discharge Requirements

The wastewater stream that is treated by the WWTP consists of sewage generated from urban land uses. There are no significant sources of major industrial waste or processing water treated by the facility (2). The WWTP discharge is currently regulated by the Santa Ana Regional Water Quality Control Board (RWQCB) under Waste Discharge and Producer/User Water Recycling Requirement (WDR) Order No. R8-2005-0044 (Santa Ana WDR) issued on June 24, 2005. There are three permitted discharge locations, summarized in Table 3-2. Discharge Point 001 for irrigation in Lucerne Valley, is located within the Colorado River Basin Region and is regulated by Colorado River Basin RWQCB WDR Order No. R7-2016-0026 (Colorado WDR), issued on June 30, 2016.

Treated secondary effluent is discharged to a 480-acre site in Lucerne Valley (LV Site) for irrigation of fodder and fiber crops that are used as feed for livestock. Use of recycled water for crop irrigation at the LV Site began in 1980 and 100% of the WWTP effluent is currently discharged to the LV Site. Figure 3-4 depicts the location of BBARWA’s existing recycled water distribution facilities and the LV Site, approximately 20 miles north of the Valley.

Table 3-2. WDR Order No. R8-2016-0044 Discharge Points

Discharge Point	Effluent Description	Receiving Water/Disposal Site	Recycling Reuse
001¹	Secondary effluent w/o disinfection	Storage Ponds in Lucerne Valley	Irrigation in Lucerne Valley
002	Secondary effluent with disinfection	State surface water (Storage pond in Baldwin Lake) and Big Bear Valley Groundwater Management Zone	Construction and wildlife habitat
003	Tertiary effluent with disinfection	Big Bear Valley Groundwater Management Zone	Irrigation

Notes:

1. The Colorado River Basin Regional Water Quality Control Board (Region 7) regulated the use of the recycled water in the Lucerne Valley (WDR Order No. R7-2016-0026).

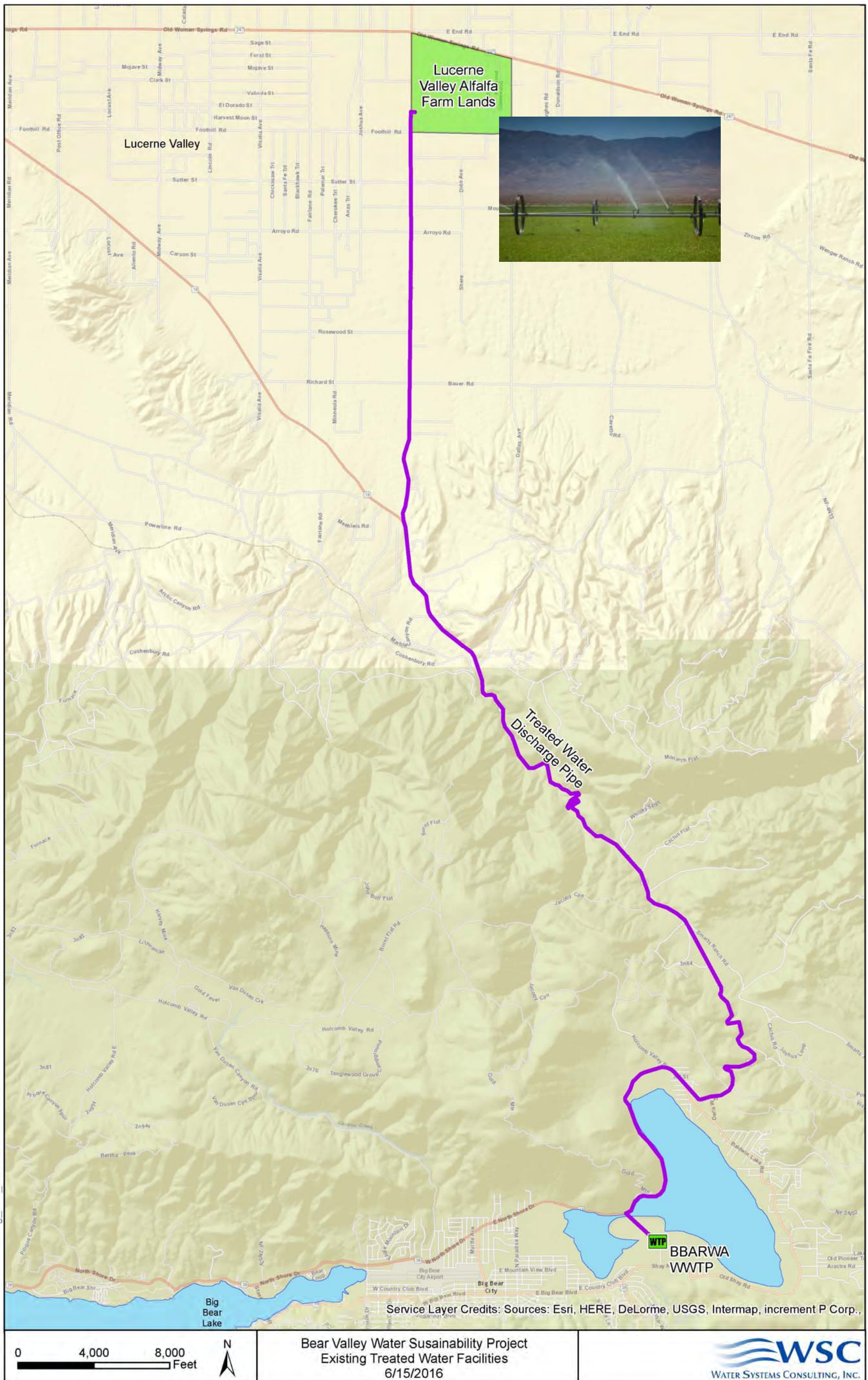

Figure 3-4. Existing Recycled Water Facilities

The effluent requirements for conventional pollutants for recycled water discharged to the LV Site contained within the Colorado WDR are presented in Table 3-3 and a summary of the actual effluent quality in 2015 is presented in Table 3-4.

The previous Colorado WDR that regulated this discharge (Board Order 01-156) included a TDS limit of a maximum of 400 mg/L above the domestic source water. The WWTP discharge was always well within compliance with this requirement. The recently updated WDR requires BBARWA to provide a technical report in the form of a study that analyzes the impacts to groundwater in the vicinity of the LV Site by the discharge and an evaluation of water quality trends. The results of the study will be used to establish an appropriate effluent limitation for TDS. BBARWA has begun the preparation of this report, which is required to be submitted by December 30, 2017 (18 months of the adoption of the Colorado WDR). Based on the background water quality in the vicinity of the LV Site and discussions with the Colorado River Basin RWQCB, it is not anticipated that the results of this study will lead to the establishment of a TDS limit lower than the current effluent TDS level. Therefore, additional treatment upgrades are not anticipated to be required to comply with this provision.

A copy of the two WDR permits are attached in Appendix A.

Table 3-3. Discharge Limits for LV Site and Actual 2015 Effluent Quality

Parameter	Units	30-Day Mean	7-Day Mean	Maximum Daily
Biochemical Oxygen Demand (BOD₅)	mg/L	30	45	-
Total Suspended Solids (TSS)	mg/L	30	45	-
Chloride	mg/L	60	-	80
Sulfate	mg/L	60	-	80
Boron	mg/L	-	-	0.75
Total Nitrogen	mg/L	10	-	-
pH	pH units	Between 6.0 - 9.0 at all times		

Table 3-4. 2015 BBARWA WWTP Effluent Quality – Annual Average

Parameter	Value	Units
TDS	453	mg/L
BOD₅	6	mg/L
TSS	13	mg/L
Chloride	56	mg/L
Sulfate	43	mg/L
Phosphorus	2.3	mg/L
Total Inorganic Nitrogen (TIN)	4.6	mg/L
pH	7.12 – 8.09	pH units

3.2.2 BBARWA Operating Budget

BBARWA's operating budget for Fiscal Year (FY) 2017 is shown in Table 3-5.

Table 3-5. BBARWA FY 2017 Operating Budget (12)

Expense Category	Budget FY 2017
Salaries and Benefits	\$ 1,933,443
Power	\$ 531,528
Sludge Removal	\$ 258,910
Chemicals	\$ 43,816
Materials and Supplies	\$ 139,421
Repairs and Replacements	\$ 141,680
Equipment Rental	\$ 770
Utilities Expense	\$ 6,337
Communications Expense	\$ 42,084
Contractual Services - Other	\$ 100,340
Contractual Services - Prof	\$ 211,272
Permits and fees	\$ 149,100
Property Tax Expense	\$ 3,705
Insurance	\$ 90,931
Other Operating Expense	\$ 58,578
Depreciation Expense	\$ 841,470
Total Operating Expense	\$ 4,553,385

3.2.3 Current Rate Schedule

BBARWA's current rate schedule is shown in Table 3-6.

Table 3-6 BBARWA Rate Schedule (12)

Member Agency	Charge per EDU
City of Big Bear Lake	\$206.37
Big Bear City CSD	\$197.35
CSA 53B	\$192.48
Connection Fee ¹	\$3,670

Notes:

1. Effective July 1, 2016

3.2.4 Capital Improvement Plan

BBARWA's 5-year Capital Improvement Plan for Fiscal Years 2017-2021 is shown in Table 3-7.

Table 3-7 BBARWA 5-year Capital Improvement Plan (12)

Primary Account	Budget FY 2017	Forecast FY 2018	Forecast FY 2019	Forecast FY 2020	Forecast FY 2021	5-Year FY 2017-2021
Administration Building	\$5,000	\$0	\$0	\$0	\$0	\$5,000
Flow Measuring Devices	\$19,271	\$26,497	\$0	\$48,031	\$0	\$93,799
Interceptor System	\$0	\$0	\$411,334	\$579,637	\$0	\$990,971
Other Equipment	\$26,408	\$33,623	\$34,343	\$138,175	\$6,708	\$239,257
Other Capital Assets	\$0	\$0	\$14,578	\$0	\$0	\$14,578
Other Tangible Plant	\$0	\$0	\$0	\$106,319	\$0	\$106,319
Power Generating Equipment	\$0	\$109,273	\$0	\$0	\$309,976	\$419,249
Transportation Equipment	\$77,800	\$0	\$0	\$93,903	\$64,706	\$236,409
Treatment Plant	\$114,126	\$292,272	\$1,751,791	\$1,644,175	\$257,105	\$4,059,469
Total	\$242,605	\$461,665	\$2,212,046	\$2,610,240	\$638,495	\$6,165,051

3.3 TREATMENT REQUIREMENTS

In order to recharge the groundwater basin or discharge recycled water to the Lake, the recycled water must meet the water quality objectives set by the Basin Plan. The Basin Plan establishes beneficial uses and water quality standards for the ground and surface waters of the region and includes an implementation plan describing the actions by the RWQCB and others that are necessary to achieve and protect the water quality standards. The Basin Plan provides a general narrative regarding the water quality objectives for each water body type and specific numeric objectives for total dissolved solids (TDS), hardness, sodium, chloride, total inorganic nitrogen (TIN), sulfate, and chemical oxygen demand (COD). Additional information about the Basin plan is provided in Appendix B. The water quality objectives for the Big Bear Valley are summarized in Table 3-8.

Table 3-8. Basin Plan Water Quality Objectives

Water Body	TDS	Hardness	Sodium	Chloride	TIN	Sulfate	COD
Inland Surface Streams							
Rathbone Creek	300	-	-	-	-	-	-
Lakes and Reservoirs							
Big Bear Lake	175	125	20	10	0.15	10	-
Wetlands (Inland)							
Stanfield Marsh (Narrative Objectives)	-	-	-	-	-	-	-
Groundwater Management Zones							
Big Bear Valley	300	225	20	10	5	20	-

3.3.1 Recycled Water Treatment Level for Groundwater Recharge

A key consideration in the development of any recycled water project is the required quality and treatment level of the recycled water as established by State Regulations. There are several factors that can drive that determination for each project. For groundwater recharge projects, the primary factors influencing level of treatment are: (1) availability of high quality dilution water in the vicinity of the recharge area; and (2) whether additional treatment is required to meet the Basin Plan Objectives for TDS for the proposed beneficial use location. Either factor can be the driver for the required treatment level, depending on the specifics of a particular project. These considerations for treatment level decisions are depicted in Figure 3-5.

The groundwater replenishment regulations in Title 22 require that the initial concentration of filtered and disinfected tertiary recycled water (Recycled Water Concentration or RWC) not exceed 20% of the total recharge water, which requires 80% of the total recharge water to come from other high quality water sources for blending. Blend water can be a combination of imported SWP water, captured stormwater, or natural underflow. If sufficient dilution water is not available from these sources, advanced purified recycled water using reverse osmosis (RO) and advanced oxidation can serve as a dilution source.

According to the Basin Plan, if the current quality of a management zone is the same as or poorer than the specified water quality objectives, then that management zone does not have assimilative capacity. If the current quality is better than the specified water quality objectives, then that management zone has assimilative capacity. If there is assimilative capacity in the receiving waters for TDS, nitrogen or other constituents, a recycled water discharge may be of poorer quality than the objectives for those constituents, as long as the discharge does not cause violation of the objectives and provided that antidegradation requirements are met. However, if there is no assimilative capacity in the receiving waters, the recycled water quality cannot be poorer than the receiving water objectives and may require additional treatment. Alternatively, the Basin Plan can be amended to specify “maximum benefit” water quality objectives, which create assimilative capacity, subject to approval by the Santa Ana RWQCB and the implementation of certain projects and actions by the responsible agencies. The assimilative capacity of the Big Bear Valley Groundwater Management Zone has not yet been evaluated. Assimilative capacity can be evaluated on a project specific basis or for the basin as whole through the Santa Ana Watershed Project Authority Basin Monitoring Program Task Force (BMPTF).

Advanced treatment that uses a RO process can be used to achieve both dilution requirements and TDS removal. Additional information on the regulations related to these considerations is provided in Appendix B.

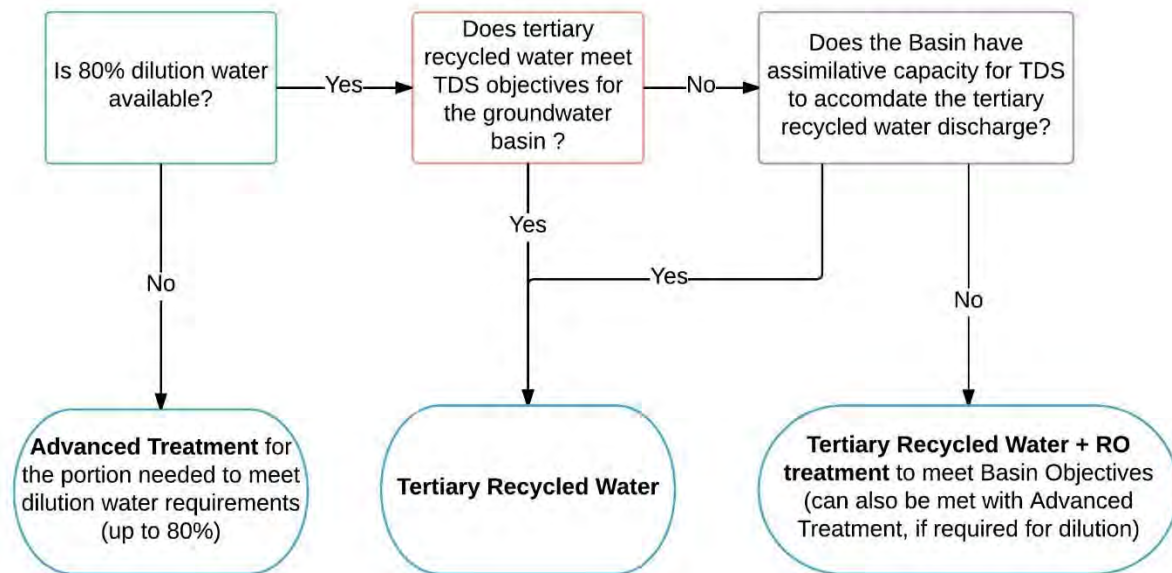

Figure 3-5. Treatment Level Considerations

At the planning level, there is some uncertainty in the treatment requirements because the available dilution water has often not been fully quantified and the ability to use assimilative capacity, if available, has not been determined. Project proponents have an opportunity to perform additional analysis to demonstrate to the RWQCB and DDW that tertiary treatment and dilution water will meet the Title 22 and Basin Plan requirements. The RWQCB and DDW will make the final decisions on the required treatment levels after review and evaluation of technical information presented by the project proponent during the permitting process.

4 RECYCLED WATER MARKET AND OPPORTUNITIES

4.1 PRIOR MARKET ANALYSIS

There is a long legacy of exploring water reuse opportunities in the Big Bear Valley for a variety of beneficial uses including wildlife habitat, landscape irrigation, surface water discharge, and groundwater recharge. Water reuse opportunities in the Valley were first investigated in 1964 and evaluations have continued intermittently since BBARWA was formed in 1974.

Appendix C includes a timeline summarizing the evolution of wastewater management in the Valley from 1935 to 2003 as well as a partial list of documents related to water reuse in the Valley, as of April 2005.

The most recent effort to develop a recycled water program in the Valley culminated with the development of the BBARWA Recycled Water Master Plan (RWMP), which was completed in 2006, and the Program Environmental Impact Report (PEIR), which examined the alternatives, put forth in the RWMP.

The 2006 RWMP evaluated several recycled water opportunities:

- Non-potable reuse for irrigation, industrial, commercial, and construction use;
- Environmental uses; and
- Groundwater recharge through surface recharge basins.

The RWMP recommended a phased implementation of a recycled water program that included both non-potable reuse and groundwater recharge at the Greenspot Recharge Site in the Erwin Lake area. Phase 1 included only groundwater recharge at the Greenspot Recharge Site. A recycled water distribution system to non-potable users was recommended for subsequent phases once assurances were obtained from potential recycled water users who would be connected.

Ultimately, the BBARWA Board certified the PEIR in 2006 and received and filed the RWMP, but decided not to approve the implementation of a recycled water project at that time.

4.2 MARKET ANALYSIS UPDATE

This Study updated the market analysis performed in the 2006 RWMP and evaluated opportunities for additional types of reuse. The types of reuse considered in this Study include:

- Landscape Irrigation
- Fish Hatchery Supply
- Surface Water Discharge
- Groundwater Recharge – Inland injection and/or surface spreading
- Direct Potable Reuse, pending future regulations

4.2.1 Landscape Irrigation

An initial list of 55 potential recycled water users in the Big Bear Valley was compiled from the users listed in the 2006 RWMP, as well as additional users identified by the Project Team. At the Alternatives Development Workshop for this Study, the Project Team reviewed this list and eliminated some potential users that: are no longer in existence or did not develop as expected; are anticipated to be closed in the near future; have low water demands; or are expected to be unwilling to convert to recycled water.

The final list of 25 potential recycled water users considered in the Study. For each user, consumption records from 2011-2014 were obtained from that user's water supplier, either BBLDWP or BBCCSD. The average of the annual consumption between 2011 and 2014 was used as the estimated recycled water demand. Where consumption records were not available, estimated demands from other studies were used. The list of potential recycled water users is shown in Table 4-1 and on Figure 4-1. Appendix D includes the sources of data used to estimate demands for each user, as well as estimates of maximum day demand and peak hour demand for each.

Table 4-1. Potential Recycled Water Users and Demands

User ID	Potential Recycled Water User	Total Annual Demand (AFY)
1	North Shore Elementary School	8.6
2	Rotary Pine Knot Park	2.6
3	Veterans Park	2.3
4	Meadow Park	0.9
5	Big Bear Middle School	12.6
6	Big Bear Elementary School	5.1
7	Big Bear Snow Play	0.1
8	City of Big Bear Lake City Hall and Village Streetscape	0.6
9	World Mark (Timeshare Resort)	20.6
10	Big Bear High School	22.2
11	Stickleback	37.8
14	Big Bear Airport District (Landscaping Meter)	0.6
15	Church of Jesus Christ Latter Day Saints	1.8
16	Erwin Lake Park	1.6
17	Gold Mountain Memorial Park (Cemetery)	0.0
22	Sonny's Place Equestrian Center	0.0
23	Whispering Pines	8.3
25	Chautauqua High School B	2.1
27	Paradise Park (Proposed)	3.0
28	Big Bear Golf Course	120.0
30	The Ranch	1.6
31	Alpine Zoo	1.5
33	Baldwin Lake Elementary	7.7
34	Sugarloaf Park	22.0
35	Otto Lawrence (Inn Der Bach)	0.5
Total		284.3

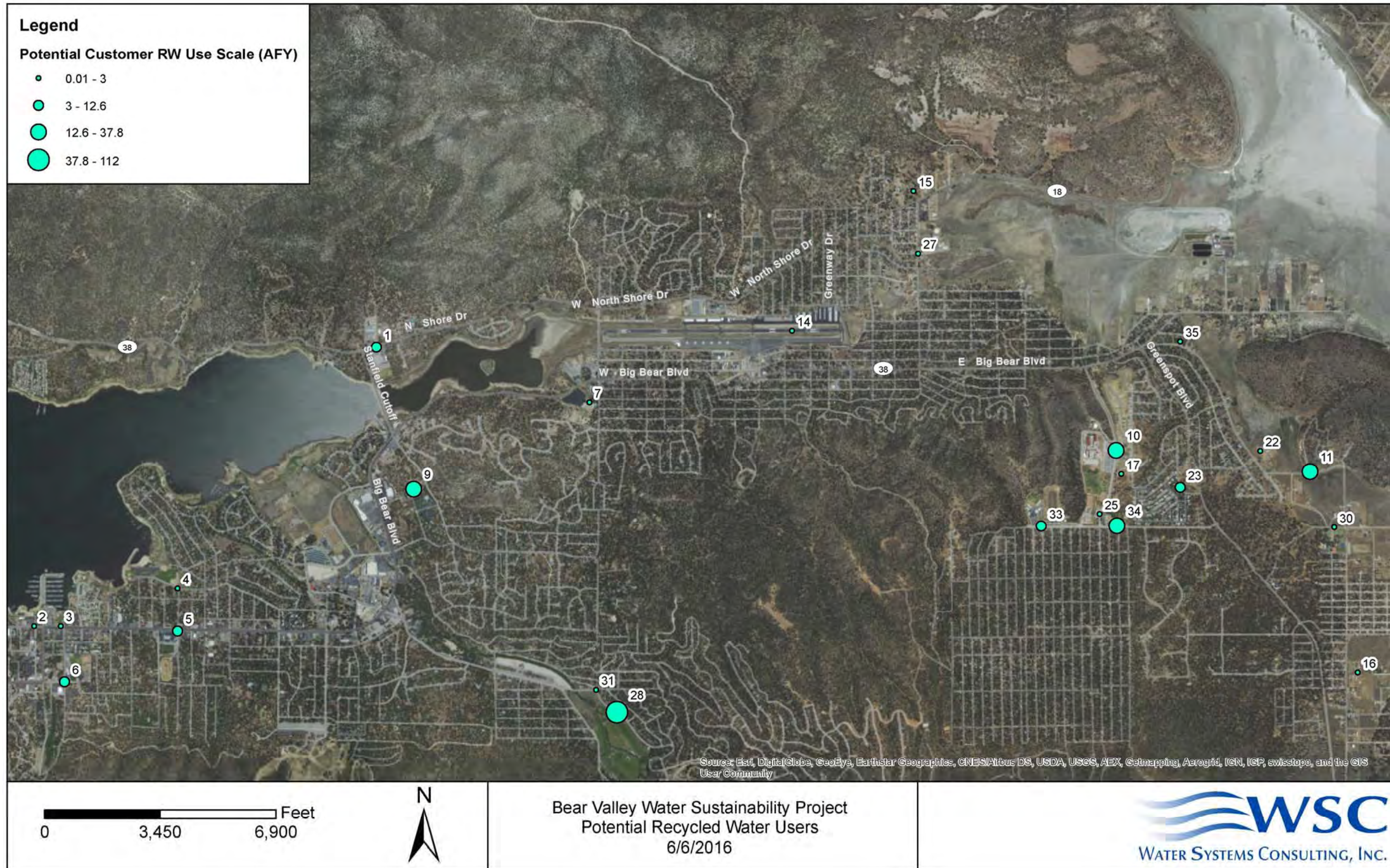

Figure 4-1. Potential Recycled Water Users

4.2.2 Fish Hatchery

One of the goals of this Study was to explore the viability of developing a fish hatchery to provide community benefits and potentially offset the costs of a project that provides a new and sustainable source of water to the Valley.

A Technical Memorandum (TM) describing a conceptual recirculating hatchery at the BBARWA WWTP site is included in Appendix I. This TM summarizes the research compiled, sources gathered, and calculations conducted regarding the fish hatchery and treatment wetlands concepts. The TM assumed the hatchery would be sized to produce 150,000 pounds of trout per year to meet the local demand for stocking the Lake. The effluent from the hatchery is assumed to be treated using a constructed wetlands system to reduce ammonia concentrations and total suspended solids and recycled water from the BBARWA plant would be provided as makeup water. A conceptual process flow diagram for the hatchery and wetlands treatment concept is shown in Figure 4-2. Additional details are provided in Appendix I.

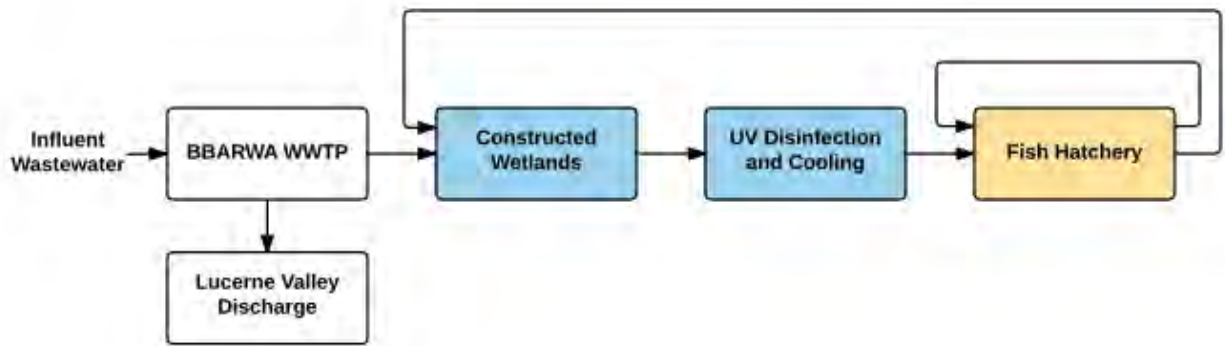

Figure 4-2. Conceptual Hatchery Process Flow Diagram

A concept level opinion of preliminary cost was developed to provide an order of magnitude estimate for the hatchery and wetlands treatment concept to help guide decisions on next steps for this concept. The preliminary estimate of annual unit cost is in the range of \$8 - \$12 per pound of fish, which is higher than BBMWD typically pays for fish from other sources, although supply from these sources is often limited.

Although impoundments at fish hatcheries are identified as an acceptable use of recycled water in Title 22, no examples of hatcheries using recycled water as a supply were identified. There are several potential environmental and regulatory hurdles to implementing a fish hatchery with a recycled water supply.

The Project Team has decided not to pursue implementation of a fish hatchery at the BBARWA WWTP site using a recycled water supply at this time. However, the alternatives analysis in Chapter 5 identifies potential opportunities to integrate a hatchery with the water supply alternatives.

4.2.3 Groundwater Recharge – Surface Spreading

The potential to supplement supply in the Big Bear Valley with recycled water using surface recharge facilities was previously evaluated by GEOSCIENCE Support Services, Inc. (GEOSCIENCE) in a 2004 Recharge Evaluation (13), as well as in prior studies. In the 2004 Recharge Evaluation, four sites were initially identified for investigation of artificial recharge potential:

- The area north of Green Spot Spring (Erwin Subunit; Eastern Baldwin Lake Watershed),
- Van Dusen Canyon (West Baldwin Subunit; Western Baldwin Lake Watershed),
- Shay Meadow Area (Erwin Subunit; central Baldwin Lake Watershed), and
- Sand Canyon (Rathbone Subunit; Eastern Big Bear Lake Watershed).

Figure 4-3 shows the potential recharge locations that were evaluated. After a preliminary evaluation of site access and environmental issues, preliminary investigations and borehole drilling, regulatory requirements, and pilot testing, the Shay Meadow and Sand Canyon sites were removed from consideration before any additional field investigations were conducted. The Green Spot Spring and Van Dusen Canyon sites were the subjects of further drilling and testing. Although not fully evaluated in the 2004 GEOSCIENCE study, the Sand Canyon recharge is included in this Study and is discussed in Section 4.2.3.4.

4.2.3.1 Greenspot Recharge Site

Analysis of the drilling and pilot recharge testing at the Greenspot site resulted in the following conclusions (13):

- The Greenspot site is located on recent alluvial deposits of permeable sand and gravel and no soil layers were observed beneath the site that would inhibit the downward percolation of recharge water to the ground water table.
- Groundwater levels start at approximately 100 ft below ground surface (bgs), which allows adequate space for mounding and storage of recharge water.
- A one-month pilot recharge test resulted in recharge rates of 3.1 to 3.7 ft/day. For planning purposes, the recharge rate is assumed to be one half of the observed rate to be conservative.
- At the seepage velocities estimated from the artificial recharge test data, ground water recharged at the Green Spot Site would reach the nearest production wells (BBLDWP's Lakewood well field) in 8.5 to 17.5 months.
- No fatal flaws were identified during the pilot recharge test.
- The property necessary to support a full-scale program at this site should include more than five acres of area for surface water spreading, plus the necessary additional land for berms and maintenance access.

In a subsequent study by GEOSCIENCE in 2005 titled *Analysis of Ground Water Flow Model Simulations for the Proposed Green Spot Artificial Recharge Site*, a calibrated groundwater flow model was used to simulate and evaluate a full-scale artificial recharge spreading basin facility at this site. The study evaluated potential changes in groundwater levels that would result from the artificial recharge of 500, 1,000, 1,500 or 2,000 AFY of water, with and without additional groundwater pumping. The study concluded that:

- An additional extraction well field downgradient of the recharge site would be needed to effectively intercept the water that is artificially recharged at the Greenspot Recharge Site. The study assumed 6 extraction wells at a rate of 100 gallons per minute (gpm) each.
- Groundwater levels can be maintained below approximately 30 ft bgs with as much as 1,000 AFY of artificial recharge during periods of below normal precipitation, provided that an equivalent amount of water is extracted at the down gradient well field.
- During wet periods, further pumping from the extraction well field and Lakewood Wells is required to artificially lower the ground water levels to maintain storage space within the aquifer in order to continue artificial recharge.
- DWR records suggest that some existing private wells are located in the vicinity of the proposed recharge basins and would be within 6-months travel time from the proposed basins. However, the exact locations of these wells will have to be verified.

4.2.3.2 *Van Dusen Site*

Analysis of the drilling and pilot recharge testing at the Van Dusen site resulted in the following conclusions (13):

- The Van Dusen site is located on recent alluvial deposits of permeable sand and gravel. Some soil layers were observed beneath the site that may inhibit the downward percolation of recharge water to the groundwater table.
- Groundwater levels start at approximately 100 ft bgs, which allows adequate space for mounding and storage of recharge water.
- A one-month pilot recharge test resulted in recharge rates of 1.1 to 1.6 ft/day. For planning purposes, the recharge rate is assumed to be one half of the observed rate to be conservative.
- At the seepage velocities estimated from the artificial recharge test data, ground water recharged at the Van Dusen Canyon site would reach the nearest production well (BCCSD Well No. 1) in approximately 106 to 160 months.
- No fatal flaws were identified during the pilot recharge test.

Given the lower recharge rates and limited availability of property, this site is not as favorable as the Green Spot Site (13). The Van Dusen Site was not considered in this Study.

4.2.3.3 *Shay Meadow Area*

The Shay Meadow site was not considered viable due to shallow ground water and environmental concerns (13) and was not considered in this Study.

4.2.3.4 Sand Canyon Site

From a geohydrologic perspective, the Sand Canyon area is very promising for artificial recharge. Sediments above the ground water consist primarily of permeable sand and the ground water surface is greater than 100 ft bgs. However, Sand Canyon was removed from consideration prior to further testing due to its distance from BBARWA, site access constraints, and regulatory issues (13). Although coordination with the flood control agency increases the complexity of project implementation, the Sand Canyon Site was included in this Study due to the significant recharge potential and proximity to BBLDWP's primary production facilities. A conceptual satellite treatment facility was evaluated as an alternative to produce a recycled water supply closer to this site.

A report prepared for BBLDWP in 1991 estimated that the long term percolation rate for the Sand Canyon stream channel is between 1.5 and 4.5 ft/day, but recommended using the minimum value of 1.5 ft/day to be conservative (14). The report estimated that approximately 750 AFY of recycled water could be recharged at Sand Canyon while meeting the minimum travel time requirement before extraction at downstream wells. Travel time and blending requirements were the limiting criteria for this analysis and the actual recharge potential may be greater. The study assumes that a series of small berms 4 ft in height would be constructed along the Sand Canyon streambed above Teton Drive with a total area of approximately 2.5 acres. As this is a flood control channel, the berms would need to be designed to allow the conveyance of flood flows through the channel and may need to be designed to wash out during large flood events.

An alternative approach later identified by BBLDWP is to modify the stream channel to slow down the flow of water to allow maximum percolation but not interfere with flood flows. This concept could include widening the stream to the extent possible to create a meandering stream with small natural ponds to slow the water down and enhance percolation. Either concept would need to be coordinated with the flood control agency to ensure that the capacity of the flood control channel remains sufficient to meet the primary purpose of providing flood protection. If these improvements resulted in a decrease in surface flow entering the Lake, the impact to surface water rights under the 1977 Judgment would need to be evaluated.

4.2.3.5 Stanfield Marsh

In addition to the sites identified in the 2004 Recharge Evaluation, the Project Team considered the concept of discharging recycled water to a drainage channel that parallels the south side of the Big Bear Airport and discharges into the Stanfield Marsh, which is tributary to the Lake. However, according to the 1998 BBARWA Engineer's Report, the Stanfield Marsh has a significant clay layer on the bottom of the marsh that prevents percolation into the surrounding groundwater basin (15). The report states that BBLDWP has wells that are less than 1000 ft from the marsh high water level and studies by BBLDWP have shown that the wells do not receive replenishment groundwater from the marsh. The report does not include the details on the underlying geology and the referenced studies were not found for review; however, this indicates that recharge at Stanfield Marsh is not a viable site for replenishment of the groundwater supply.

Additionally, since the Stanfield Marsh is hydraulically connected to the Lake, discharges to the Stanfield Marsh would likely be required to meet water quality objectives of the Lake. The TDS objective for the Lake is 175 mg/L, which would require a significant portion of the discharge to receive RO treatment to reduce TDS. Due to the apparent absence of a water supply benefit, the Stanfield Marsh was not considered for recharge as part of this Study. However, further evaluation could be conducted to assess whether recharge in the bottom of the drainage channel along the south side of the airport would recharge the shallow aquifer and provide a water supply benefit.

The Stanfield Marsh and the Lake are designated as Municipal Supply in the Basin Plan. While the water in the Lake is not used locally for municipal supply, discharges from the Lake enter Bear Creek and are collected downstream at the confluence with the Santa Ana River and are ultimately delivered to two drinking water filtration plants that provide municipal supply in the San Bernardino Valley. The 1998 BBARWA Engineer's Report states that retention time for recycled water discharged to the Lake would be in excess of 20 years. Once released from the Lake, water traveling through Bear Creek provides an additional environmental buffer. Due to the magnitude of the environmental buffer, discussions with DDW indicated that discharge of recycled water to the Lake would not be regulated as surface water augmentation.

Although DDW has indicated that discharging of recycled water to the Lake would not be regulated by that agency, a National Pollutant Discharge Elimination System (NPDES) permit issued by the Santa Ana RWQCB would be required for any discharges to waters of the United States (i.e. rivers, lakes, wetlands, and oceans). An NPDES permit may be issued in conjunction with a WDR Order. The NPDES permit will establish numerical limitations on the concentrations of pollutants that can be in the discharge water. The limitations are based on treatment technology capabilities and surface water uses. The water quality objectives for the Lake in the Basin Plan would apply and would therefore require salt removal before discharge into the Lake, and may require treatment for other criteria that apply to the Lake. Since recycled water discharge to the Lake was not tied to a direct water supply benefit, this alternative was not evaluated in this Study.

The 2004 Recharge Evaluation noted that other sites that have not been previously considered for artificial recharge applications may exist in the Valley, but would require further studies to identify and test.

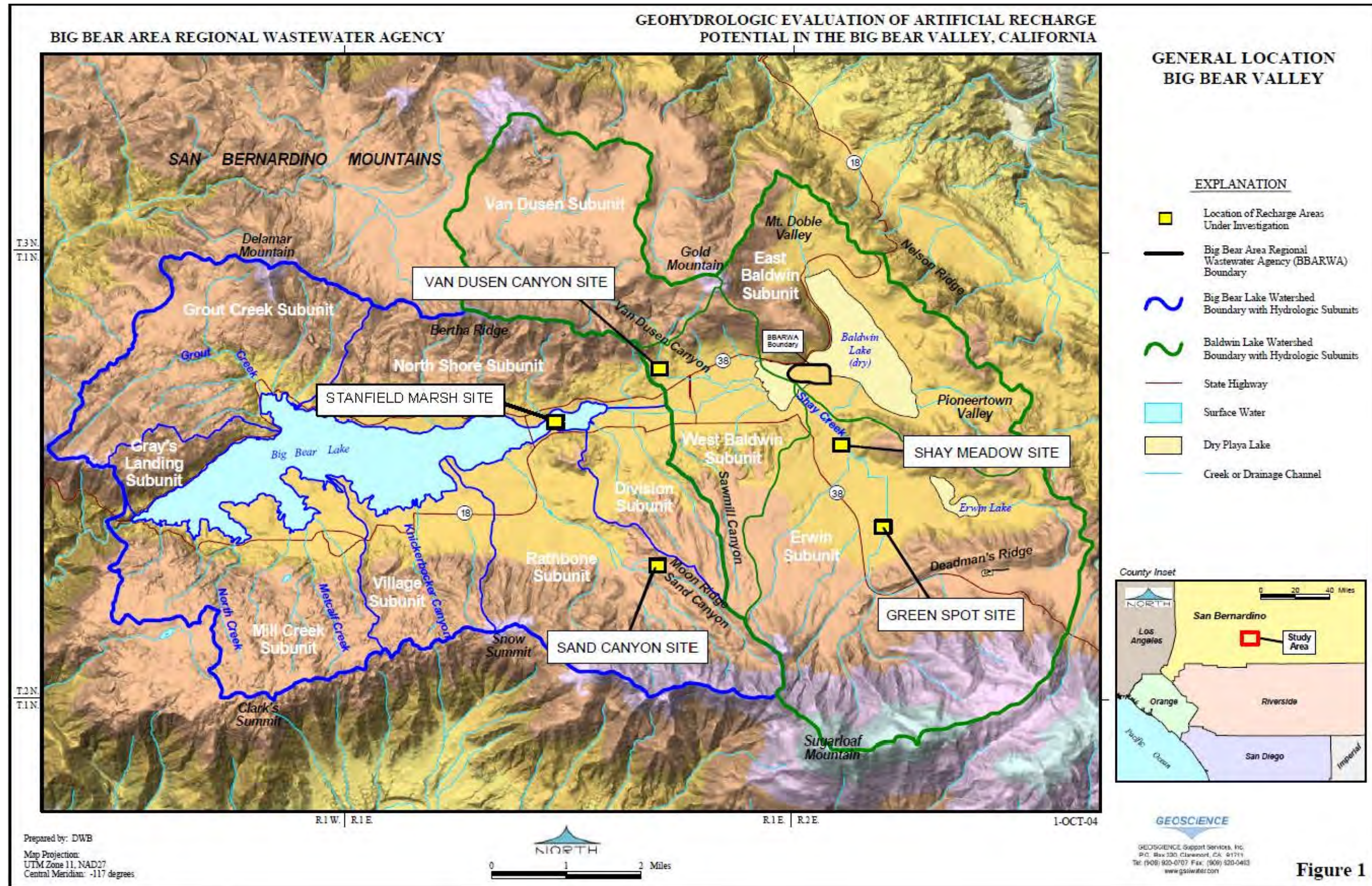

Figure 4-3. Potential Recharge Areas Evaluated (13)

4.2.4 Groundwater Recharge – Subsurface

The Groundwater Recharge Regulations also regulate subsurface recharge via injection wells. Due to the existence of viable surface recharge sites in the Valley and the operational and maintenance requirements of injection wells, the Project Team chose not to evaluate subsurface groundwater recharge in this Study.

4.2.5 Direct Potable Reuse

Direct Potable Reuse involves the use of advanced treatment technologies to purify wastewater for use as municipal drinking water. Recycled water may be introduced into the raw water supply directly upstream of a drinking water treatment facility, or an advanced water treatment facility may be permitted as a drinking water treatment facility and water is introduced directly into the public water system. Either alternative may require an engineered storage buffer as part of the purification process.

Water agencies in California have begun evaluating the possibility of implementing DPR as a source of local water supply; however, there are currently no regulations for direct potable reuse. Senate Bill (SB) 918 approved on September 30th, 2010 and subsequent SB 322 approved on October 8th, 2014 directed the California Department of Public Health (CDPH), to investigate the feasibility of developing uniform water recycling criteria for DPR (CDPH's responsibilities have since been transferred to the SWRCB's DDW). Additionally, the bills required SWRCB to convene an expert panel for technical and scientific issues, and an advisory group to advise the expert panel and the SWRCB on the development of the feasibility report. The SWRCB will consolidate the information from the expert panel report and provide the findings in a Report to Legislature. A draft Report to Legislature providing recommendations related to the feasibility of developing regulatory criteria for DPR was released for public comment on September 1, 2016, and the final Report to Legislature is due by December 31st, 2016. The expert panel's feasibility report is available as an attachment to the Report to Legislature.

Since there is no surface water treatment plant in the Valley, a potential future DPR project in the Valley may be designed to introduce advanced purified water directly into the potable water system after retention in an engineered water storage buffer. As noted above, DPR is not currently regulated in California but it is recommended that the Bear Valley Agencies continue to track the evolution of recycled water regulations and consider exploring a DPR concept as a long term strategy to increase recycled water use within the Valley.

5 PROJECT ALTERNATIVES ANALYSIS

This section describes the development of the alternatives and the alternatives analysis process used to select the preferred alternative. Appendix E includes a summary of the technical criteria and financial assumptions used for this analysis. Section 6 provides discussion of the following:

- Details of each alternative and the no-project alternative
- Water conservation and reduction analysis
- Alternatives analysis considerations

5.1 ALTERNATIVES EVALUATED

At the Alternatives Development Workshop, the following three recycled water project alternatives were selected for further development and evaluation in this Study:

- Alternative 1: Disinfection Tertiary Landscape Irrigation
- Alternative 2: Groundwater Recharge at Greenspot
- Alternative 3: Groundwater Recharge at Sand Canyon
- Alternative 4: Groundwater Recharge at Greenspot & Sand Canyon

The following subsections provide details of potential use of the recycled water, infrastructure requirements, recycled water unit cost, location, advantages, and disadvantages for each alternative.

5.1.1 Alternative 1: Disinfected Tertiary Landscape Irrigation

Alternative 1 includes upgrading BBARWA's existing WWTP to tertiary treatment for production of Title 22 disinfected tertiary water for landscape irrigation throughout the Valley. Beneficial use of recycled water for disinfected tertiary landscape irrigation is permitted in unrestricted access areas such as school yards, parks and golf courses.

5.1.1.1 Treatment Upgrades

To implement Alternative 1, the BBARWA WWTP would need to upgrade to a tertiary treatment process to produce Title 22 disinfected tertiary recycled water (RW). BBARWA's existing secondary treatment and clarification facilities are assumed to be sufficient for adequate BOD and TSS removal prior to tertiary treatment. The new treatment processes required at the BBARWA WWTP to produce disinfected tertiary recycled water include:

- Tertiary filtration. Cloth media filters are assumed as the tertiary filtration process because the technology is offered by multiple vendors, easy to operate and low cost.
- Disinfection. Chlorination is assumed as the disinfection process because the BBARWA staff is familiar with chlorine dosing systems, and chlorination provides adequate disinfection to reliably produce disinfected tertiary RW.

A process flow diagram (PFD) for Alternative 1 is shown in Figure 5-1. The new facilities required for this alternative are outlined in blue. Additional detail on each of the treatment systems is provided in Appendix F.

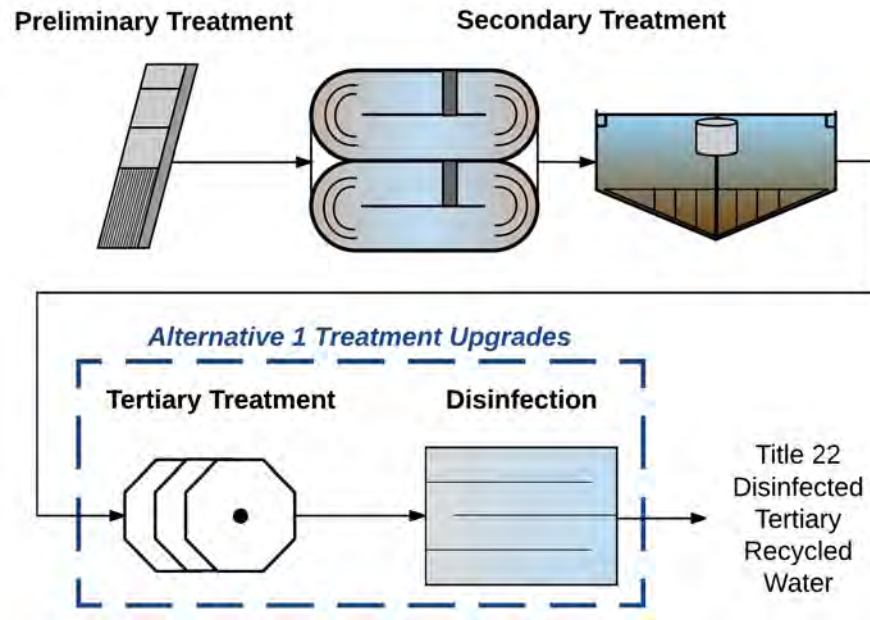

Figure 5-1. Treatment Process Flow Diagram for Alternative 1

5.1.1.2 Potential Landscape Irrigation in Big Bear Valley

As described in Section 4.2.1, 25 potential recycled water users were identified. These users can be served with disinfected tertiary recycled water for landscape irrigation. Conceptual pipeline alignments were developed to deliver recycled water to the largest users throughout the valley, while serving other, smaller RW users along the way. Potential users which were not in proximity to the pipeline alignments were assumed not to be served with recycled water. The potential users with the largest estimated annual demand include the WorldMark (20.6 AFY), Sugarloaf Park (22 AFY), Big Bear Middle School (12.6 AFY), Big Bear High School (22.2 AFY) and Big Bear Golf Course (120 AFY). Big Bear Golf Course currently pumps from private wells and may be unwilling to convert to recycled water due to the cost of recycled water conversion and service. Additionally, the Big Bear Valley agencies have indicated the WorldMark timeshare resort is removing turf and their future RW demand may be significantly lower than currently estimated.

Alternative 1 is broken down into seven incremental segments numbered 1.1 to 1.6. Segment 1.1 represents a complete and independent portion of the recycled water system, extending south of the WWTP to serve potential customers in the community of Sugarloaf. The remaining segments 1.2 to 1.6 extend west from the WWTP as shown in Figure 5-2.

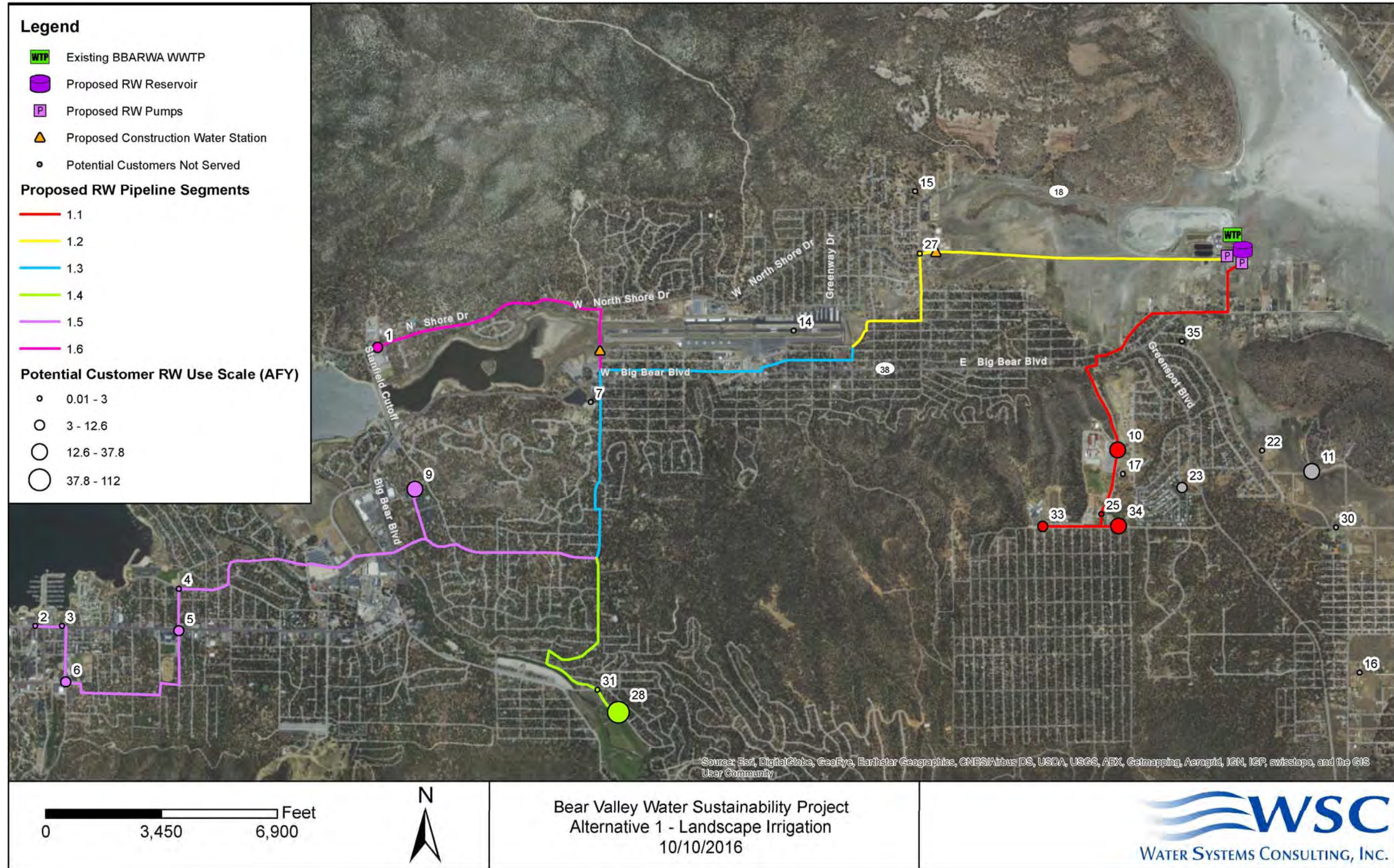

Figure 5-2. Alternative 1 Overview

The infrastructure analysis and cost estimates are presented incrementally and cumulatively by segment to illustrate how unit costs and infrastructure requirements vary as additional segments are implemented. This approach allows the Project Team to make cost versus benefit based decisions to incrementally expand the system as determined feasible.

Depending on which RW distribution system segments are constructed, the beneficial use yield ranges from 54 – 231 AFY, or approximately 3 - 12% of the total treated effluent from BBARWA in 2015. If the demand from the Big Bear Golf Course is excluded, the maximum yield would be 111 AFY, or 6% of the total treated effluent in 2015. Potable water demands could potentially be offset further through use of recycled water for construction uses, although it is not expected to be a significant or consistent future use. Table 5-1 provides a summary of the annual average demand in AFY of each segment.

Table 5-1. Customers and Annual Average Demand by Segment

Segment	Number of Customers Per Segment	Segment Annual Average Demand (AFY)	Cumulative Demand (AFY)
1.1	4	54	54
	10 - Big Bear High School	22.2	
	25 - Chautauqua High School B	2.1	
	33 - Baldwin Lake Elementary	7.7	
	34 - Sugarloaf Park	22.0	
1.2	1	3	57
	27 - Paradise Park	3.0	
1.3	0	0	57
1.4	2	121	178
	28 - Big Bear Golf Course	120	
	31 - Alpine Zoo	1.5	
1.5	6	44	222
	2 - Rotary Pine Knot Park	2.6	
	3 - Veterans Park	2.3	
	4 - Meadow Park	0.9	
	5 - Big Bear Middle School	12.6	
	6 - Big Bear Elementary School	5.1	
	9 - World Mark	20.6	
1.6	1	9	231
	1 - North Shore Elementary School	8.6	

5.1.1.3 Storage, Pumping & Distribution System

Implementation of Alternative 1 would require the construction of a storage tank and two RW booster pump stations at the BBARWA WWTP. To distribute the disinfected tertiary RW, 2.29 to 13.0 miles of recycled water mains would need to be installed, depending on the segments implemented. The onsite storage tank would range from 120,000 to 600,000 gallons in cumulative capacity, and function as a suction reservoir for the RW booster pump stations. The Project Team recently became aware of a 500,000-gallon modular precast concrete storage tank which was available from the U.S Army Corps of Engineers (COE). A cost analysis was performed to compare the value of transporting and erecting the precast tank with construction of a traditional cast-in-place concrete tank. It was determined the potential cost savings in purchasing the precast tank from the COE was outweighed by the risk of tank degradation or damage during storage and transport, therefore, the cost estimates in this Study are based on construction of a new storage tank. Appendix J includes the cost estimate and memorandum detailing the results of the cost analysis.

Segment 1.1 is independent of the others and would require a 248 gpm booster station which operates at a hydraulic grade line (HGL) of 7,200-ft. The remaining segments would require a cumulative booster pump station capacity for ranging from 17 - 990 gpm, and would operate at an HGL of 7,010-ft. System HGLs are selected to maintain the RW HGL 10 ft below the corresponding potable water system HGL for a given customer. By maintaining a lower pressure in the RW system reduces the risk of contamination of the potable water system in the event of a cross-connection between the two systems. Because segments 1.2-1.6 serve customers located in different potable pressure zones, some connections may require a pressure regulator to maintain an HGL that is lower than the potable HGL. The storage, pumping and distribution facilities are summarized in Table 5-2 and Table 5-3.

Table 5-2. Alternative 1 Facilities Summary

Segment #	Segment Annual Average Demand (AFY)	Cumulative Demand (AFY)	Segment Storage ¹ (MG)	Cumulative Storage (MG)	Segment Booster Pump Capacity ² (gpm)	Cumulative Booster Pump Capacity ² (gpm)
1.1	54	54	0.13	0.13	248	272
1.2	3	57	0.08	0.21	17	17
1.3	0	57	-	0.21	-	17
1.4	121	178	0.35	0.56	720	737
1.5	44	223	0.10	0.66	205	942
1.6	9	231	0.02	0.68	49	991

Notes:
 1. RW Storage sized for one maximum day demand (MDD)
 2. Equal to peak hour demand (PHD). Segment 1.1 has a separate booster pump sized for 7200' HGL. Booster pump capacity for Segments 1.2-1.6 is cumulative, sized for 7010' HGL.

Table 5-3. Alternative 1 Pipeline Summary

Segment	Pipelines (miles)	Cumulative Pipeline Length (miles)	Pipe Size (in) ¹
1.1	2.29	2.29	4, 6, 8
1.2	2.15	4.44	12
1.3	2.17	6.61	12
1.4	1.15	7.76	10
1.5	3.79	11.6	4, 6
1.6	1.44	13.0	4

Notes:
 1. Pipe sizing is based on all segments being constructed to serve all customers. Some sizes can be reduced if subsequent segments are not constructed.

5.1.1.4 Operational Requirements

It is estimated that the operation and maintenance of the treatment and distribution upgrades will require an additional 0.5 full time equivalent (FTE). The labor costs associated with the operations are included in the Annual Operation and Maintenance (O&M) costs presented in Section 5.1.1.5.

5.1.1.5 Unit Cost

The unit cost for Alternative 1 is broken down by each segment considered for the RW distribution system, as shown in Table 5-4. Itemized cost estimates for each segment are included in Appendix G.

Table 5-4. Unit Cost for Alternative 1

Segment #	Total Capital Cost	Annual O&M	Segment Unit Cost	Cumulative Unit Cost
1.1	\$3.26 M	\$65,000	\$3,950	\$3,950
1.2, 1.3 & 1.4	\$11.4 M	\$101,000	--	\$5,010
1.5	\$4.06 M	\$30,000	\$4,880	\$4,980
1.6	\$1.31 M	\$11,000	\$8,250	\$5,140

5.1.1.6 Advantages and Disadvantages

Compared to the groundwater recharge alternatives, the disinfected tertiary alternative is the easiest to implement in terms of regulatory approval and treatment upgrades. Regulations for disinfected tertiary RW production for landscape irrigation are established and well understood, so minimal regulatory barriers are anticipated for implementation of Alternative 1. BBARWA’s Santa Ana WDR already includes the use of tertiary treated disinfected effluent for irrigation in the Big Bear Valley Groundwater Management Zone. Various proprietary cloth media filters are approved by the CDPH as a Title 22 filtration process, therefore effluent water quality is expected to be reliable. BBARWA staff also maintain some familiarity with chlorine dosing systems from prior RW practices.

The BBARWA WWTP is distant from a majority of the potential RW users, requiring 13 miles of pipelines and booster station energy to distribute the RW throughout the Valley. Segment 1.1 provides the lowest unit cost but results in only 54 AFY of recycled water yield, or 3% of the total available treated effluent. The remaining segments have a significantly higher unit cost and are based on the assumption that all potential RW users convert to RW, although the Big Bear Valley agencies have expressed uncertainty in the willingness for some customers to convert. Specifically, the WorldMark Resort has been removing turf and their future irrigation water use is expected to decline, and the golf course currently owns private wells that produce water at a much lower cost than the Alternative 1 unit cost. Without these types of significant users, the unit cost of the RW in Alternative 1 increases considerably.

The maximum potential benefit of Alternative 1 is keeping 231 AFY of water in the valley, or roughly 13% of what was exported in 2015. With the added uncertainty of customer conversion to RW that would increase unit cost and reduce beneficial use yield, Alternative 1 does not adequately address the Bear Valley agencies' goal of developing a cost effective, drought proof and sustainable water source.

5.1.1.7 Potential Refinements

Alternative 1 does not beneficially use all of the treated effluent in the Valley but could potentially co-exist with a fish hatchery at the BBARWA WWTP site that uses excess treated effluent to provide makeup water to a recirculating fish hatchery treatment system. If a wetlands system is used as part of a fish hatchery treatment system, that process could potentially be used to produce tertiary treated disinfected recycled water for landscape irrigation customers. A conceptual PFD for this concept is depicted in Figure 5-3.

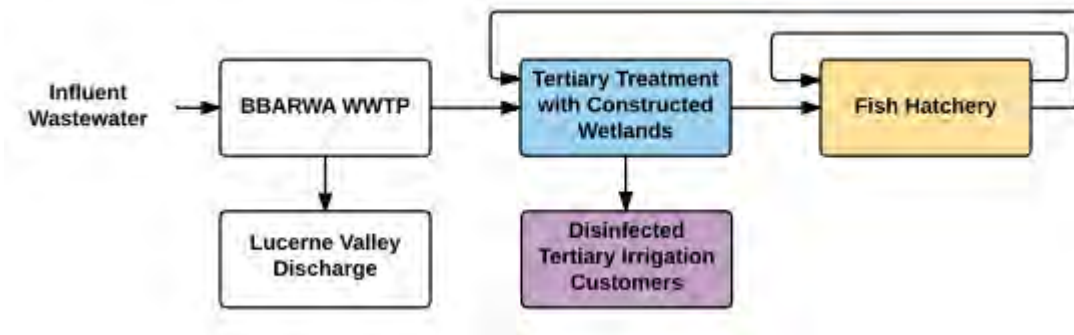

Figure 5-3. Alternative 1 Potential Refinement Process Flow Diagram

5.1.2 Alternative 2: Groundwater Recharge at Greenspot

Alternative 2 includes upgrading BBARWA's existing WWTP to include tertiary and advanced treatment for production of both disinfected tertiary water and advanced purified water for groundwater recharge at the Greenspot Recharge Site. As discussed in Section 4.2.3.1, the anticipated recharge capacity at the Greenspot site is 1,000 AFY, subject to sufficient pumping from the nearby extraction well field to maintain storage volume in the basin.

5.1.2.1 **Treatment Upgrades**

For Alternative 2, BBARWA's existing secondary treatment and clarification facilities are assumed to be sufficient for adequate BOD and TSS removal prior to tertiary treatment. The secondary effluent from the existing WWTP would be fed to the advanced treatment process train consisting of:

1. Microfiltration/ultrafiltration (MF/UF)
2. Reverse Osmosis (RO)
3. Ultraviolet Advanced Oxidation (UV/AOP)
4. Brine Disposal

The combination of MF, RO and UV/AOP is considered the conventional indirect potable reuse treatment train. This treatment train meets the criteria in the DDW Regulations Related to Recycled Water (Title 22, Article 5.2).

One of the issues with the RO process is that the TDS removed from the feed water is concentrated into a brine stream that needs to be disposed of. Based on the results of previous investigations and pilot testing of brine treatment and disposal alternatives for the BBARWA WWTP, the recommended method of brine disposal was effluent mixing coupled with brine reduction and evaporation ponds (16). Under this scenario, a portion of the brine would be mixed with the secondary effluent that is discharged to the LV Site for irrigation. The portion of brine that is mixed would be limited to ensure that the effluent meets the discharge requirements of the Colorado WDR permit for the LV Site. For the remaining brine, Vibratory Shear-Enhanced Processing (VSEP) would be used to reduce the volume of concentrate. The reduced concentrate would then be conveyed to new, lined evaporation ponds on the LV Site. A smaller brine pipeline would be installed inside the existing discharge pipeline to the LV Site. Note that this brine management scheme is dependent on BBARWA's WDR TDS effluent limits for discharge to the LV Site; as stated in Section 3.2.1, the TDS limit will be revised following a site specific study scheduled for completion in December 2017. The brine disposal costs for this alternative are based on this scenario and costs were estimated by escalating the costs estimates in the prior report to the cost basis used in this Study.

A PFD for Alternative 2 is shown in Figure 5-4. The new facilities required for this alternative are outlined in blue. Additional detail on each of the treatment systems is provided in Appendix F.

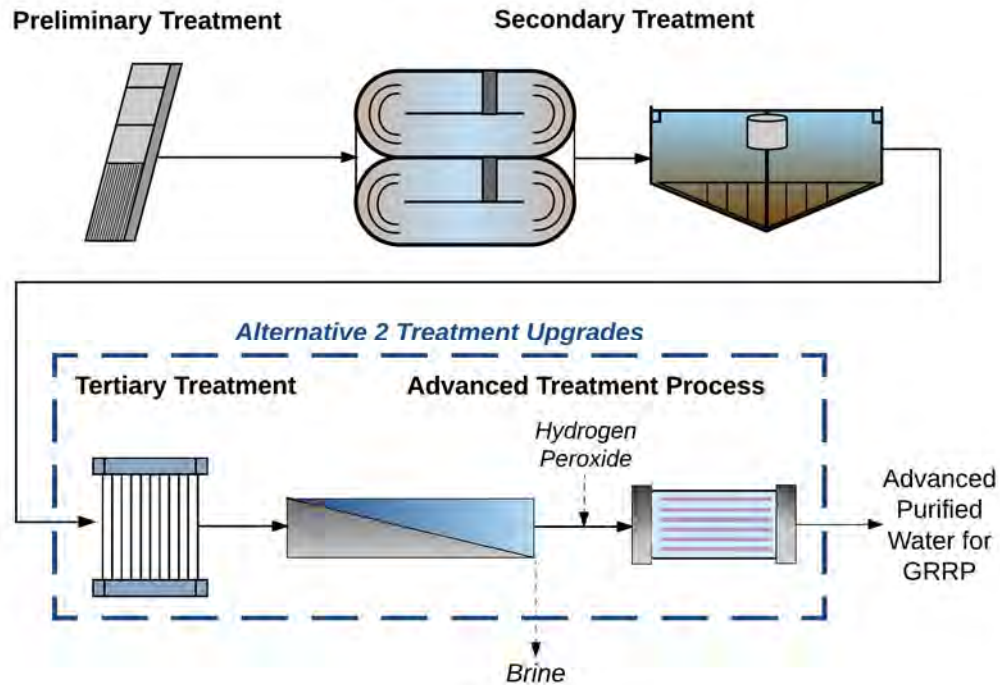

Figure 5-4. Treatment Process Flow Diagram for Alternative 2

5.1.2.1.1 Advanced Treatment Blending Considerations

As discussed in Section 3.3.1, there are two primary factors that influence the requirement for advanced treatment: the RWC and the water quality objectives for the beneficial use location.

Based on the prior Greenspot recharge analysis discussed in Section 4.2.3.1, total inflow to the Erwin Subunit is approximately 900 AFY. Dilution credit can be obtained for the portion of this flow in the uppermost portion of the aquifer in the vicinity of the recharge site. The prior studies did not provide this level of detail but, based on the proportional area of the approximate recharge area to the total model area, the underflow in the vicinity of the recharge basins may be on the order of 100 AFY. The sum of underflow and advanced purified water must be 80% of the total water in the recharge area, such that tertiary RW is equal to 20% of the total water to meet the RWC requirement. Assuming an underflow credit of 100 AFY, advanced treatment of 78% of the recharge water would be required to meet the initial RWC requirement of 20%, as shown in Table 5-5.

Table 5-5 Water Sources for Alternative 2 Groundwater Recharge

Water Source	Contribution, AFY	Contribution, % of Total
Tertiary RW	220	20%
Advanced Purified Water	780	71%
Underflow	100	9%
Total	1,100	100%

The assimilative capacity for TDS in the Big Bear Valley Groundwater Management Zone has not been determined so a range of potential assimilative capacities was considered for this analysis. Recent water quality samples taken at BBLDWP's nearby Lakewood Wells showed an average TDS concentration of 230 mg/L. As the groundwater objective is 300 mg/L, it is assumed that the increment of 70 mg/L would be the maximum assimilative capacity available. Other locations in the basin have current TDS levels in excess of the TDS Objective, so it is likely that there may be no assimilative capacity for TDS, depending on the methodology applied. Based on the range of assimilative capacity for TDS from 0 to 70 mg/L, 30-45% of the flows would need to be treated with MF and RO to comply with the Basin Plan.

The RWC requirement of 78% advanced treatment controls. For Alternative 2, it is assumed that 22% of the recharge water will receive tertiary treatment and 78% will receive advanced treatment to meet groundwater recharge blending requirements and the Basin Plan objective for TDS. The treatment process will be sized to produce 1,000 AFY of blended water for recharge and the remaining flows treated at the existing BBARWA WWTP will continue to be discharged to the LV Site.

A simplified PFD representing this blending scenario is shown in Figure 5-5.

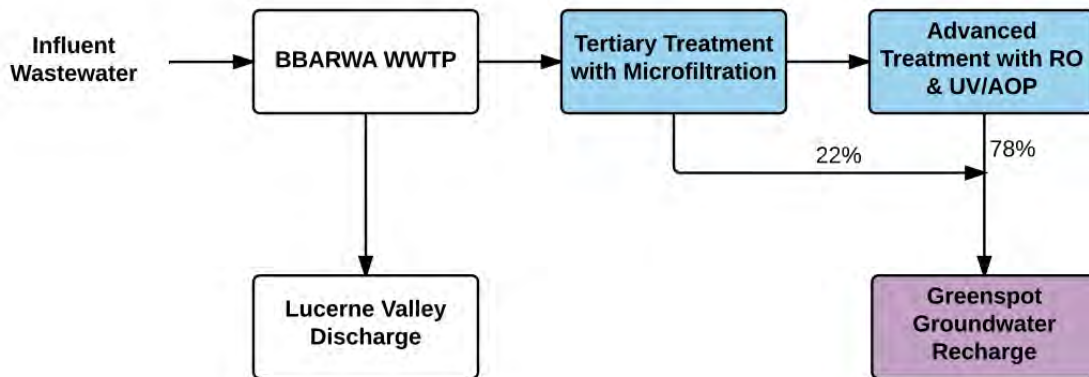

Figure 5-5. 22% Tertiary/78% Advanced Treatment Process Flow Diagram for Alternative 2

5.1.2.2 Distribution System & Recharge Facilities

Approximately 16,200 ft of 12-in pipeline is required to convey the RW to the Greenspot Recharge Site. A new 0.9 MG storage tank and approximately 620 gpm pump station would also be constructed on the BBARWA WWTP site for storage and conveyance to the recharge ponds.

The Greenspot Recharge Site is assumed to be a 7-acre site to allow more than five acres of area for surface water spreading, plus the necessary additional land for berms and maintenance access.

This alternative includes the addition of 6 extraction wells downgradient of the recharge site to effectively intercept the water that is artificially recharged at the Greenspot Recharge Site. The Greenspot recharge facilities also include 2 monitoring wells for sampling and monitoring the groundwater water quality in accordance with the Groundwater Recharge Regulations. These wells are assumed to have a pumping capacity of 100 gpm each.

The location of the facilities required for Alternative 2 are shown in Figure 5-6.

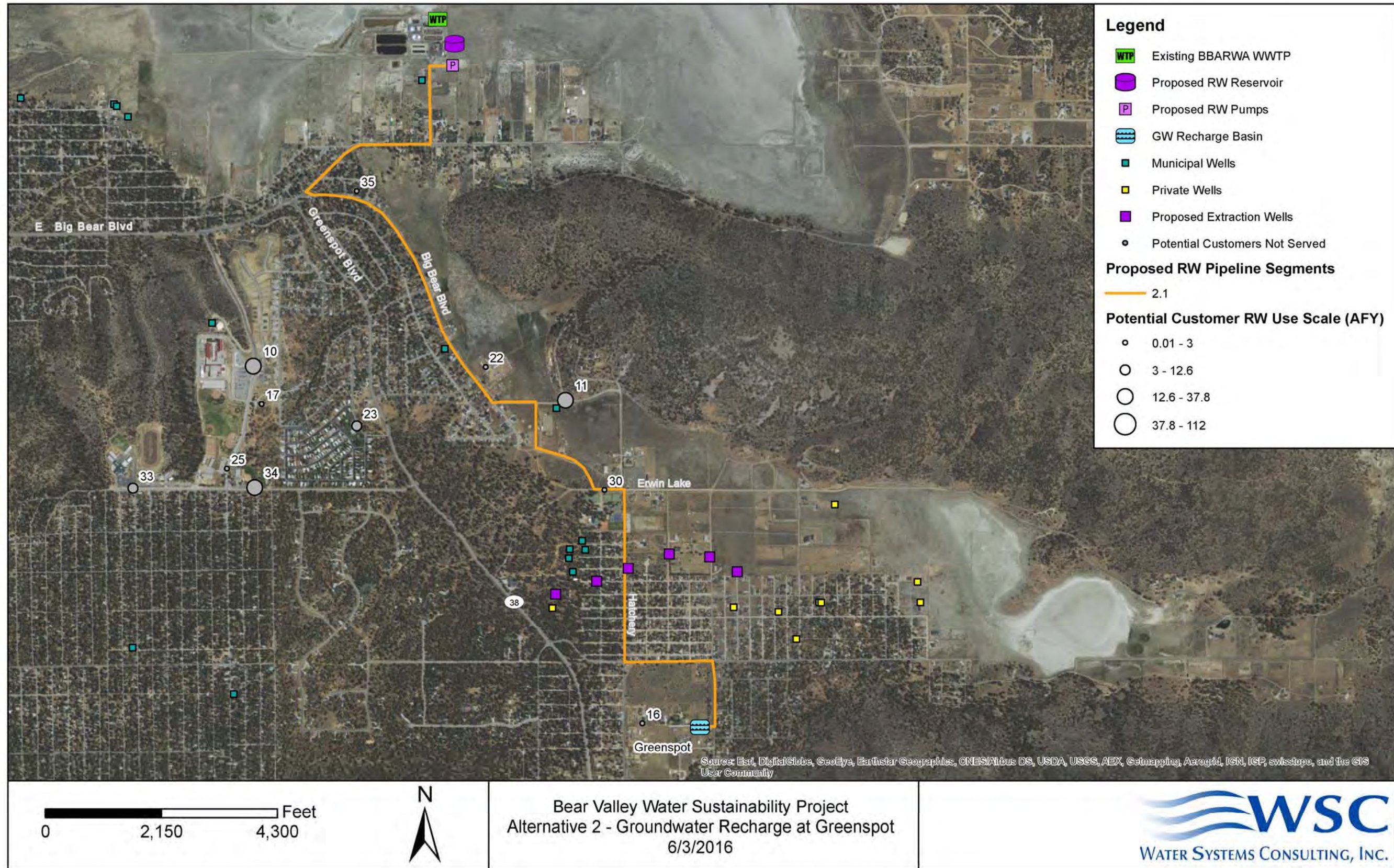

Figure 5-6. Alternative 2 Overview

5.1.2.3 *Operational Requirements*

It is estimated that the operation and maintenance of the treatment and distribution upgrades for Alternative 2 will require an additional 1.5 FTE. The labor costs associated with the operations are included in the Annual O&M costs presented in Section 5.1.2.4.

5.1.2.4 *Unit Cost*

The unit cost for Alternative 2 is shown in Table 5-6. Itemized costs estimates are included in Appendix G.

Table 5-6. Unit Cost for Alternative 2

Total Capital Cost	Annual O&M	Unit Cost (\$/AF)
\$44,533,000	\$1,539,000	\$3,580

5.1.2.5 *Advantages and Disadvantages*

Alternative 2 provides the highest recycled water yield and retains 50% of the available treated effluent in the Valley.

Recharge at the Greenspot site has been evaluated extensively in the past through groundwater modeling and pilot recharge testing. Therefore, there are relatively few uncertainties regarding the implementation, operation, and effectiveness of this alternative. Determination of the underflow credit using the existing groundwater model will be needed to confirm the advanced treatment volume required to meet RWC blending requirements.

The available groundwater storage in the Erwin subunit is relatively small so recharge and extraction operations will need to be closely coordinated to avoid excessive increase or decrease of water level in the vicinity of the recharge site. BBLDWP and BBCCSD would need to shift a significant portion of their production to the new or existing wells located downstream of the recharge site.

BBLDWP's existing Lakewood and Maple wells in this area are already underutilized and shifting production to their Erwin Lake system is not desirable for the operation of their water system. The Erwin Lake Zone is the lowest zone in their water system, has the fewest customer connections, and is remote from the rest of BBLDWP's water system.

Water recharged at the Green Spot Site would reach the nearest known production wells (BBLDWP's Lakewood well field) in 8.5 to 17.5 months, which meets the travel time and retention time requirements in the groundwater recharge regulations. However, DWR records suggest that some existing private wells are located in the vicinity of the proposed recharge basins and would be within 6-months travel time from the proposed basins. The exact locations of these wells will have to be verified and mitigation measures may need to be identified and implemented if there is not sufficient travel time from these wells.

Alternative 2 does not provide habitat or recreational benefits to the Lake or the community.

5.1.2.6 Potential Refinements

Another potential environmental use in this area is to provide recycled water for the Shay Creek unarmored threespine stickleback fish habitat. This particular stickleback fish is a state- and federally listed endangered species. Since 1985, the BBCCSD has provided potable water to the pond to maintain the wetland habitat that supports this federally listed endangered fish. The average volume of potable water provided to the stickleback habitat between 2011 and 2014 was 38 AFY. The pipeline to the Greenspot recharge site runs near the Shay Pond and could be connected to the Shay Pond by adding approximately 400 ft of pipe. This would provide an additional potable water offset of 38 AFY. However, due to the sensitivity of the species, coordination with several resource agencies would be required and there may be difficulty obtaining regulatory approval for this use.

Alternative 2 does not beneficially use all of the treated effluent in the Valley but could potentially co-exist with a fish hatchery at the BBARWA WWTP site that uses the excess treated effluent to provide makeup water to a recirculating fish hatchery treatment system. A conceptual PFD for this concept is depicted in Figure 5-7.

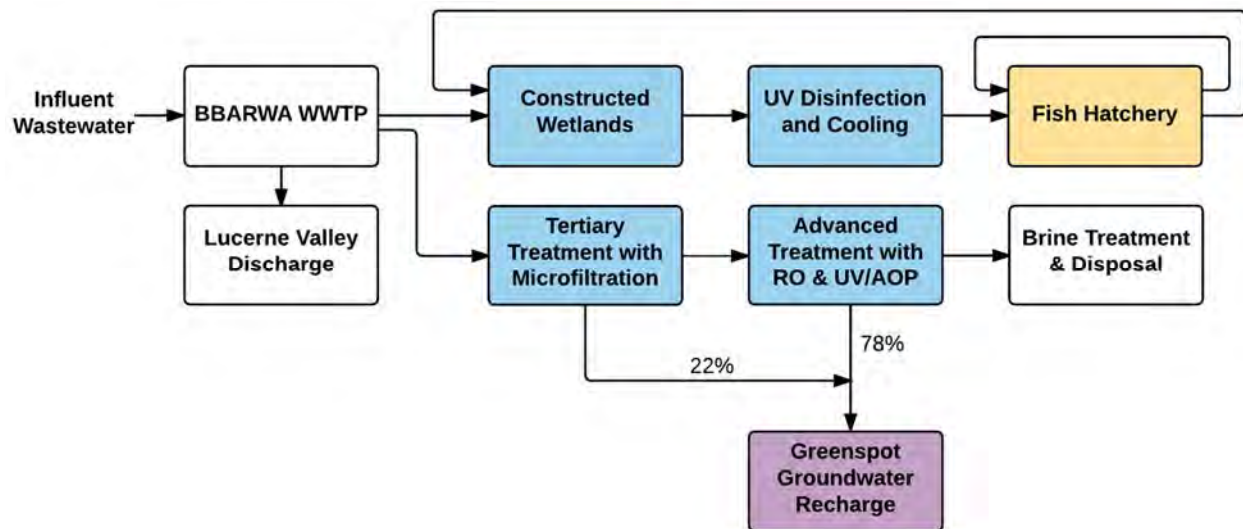

Figure 5-7. Alternative 2 Potential Refinement Process Flow Diagram

5.1.3 Alternative 3: Groundwater Recharge at Sand Canyon

Alternative 3 includes a new satellite advanced treatment facility located near BBARWA’s existing Lake Pump Station, which is the sewer lift station that currently conveys waste water from the City of Big Bear Lake to the BBARWA WWTP. The satellite WWTP would produce both disinfected tertiary recycled water and advanced purified water for groundwater recharge at the Sand Canyon Recharge Site.

In 2014, the average annual flows to the Lake Pump Station were 0.84 MG and minimum daily flows of approximately 0.50 MGD are observed in the spring and fall months. The capacity of the satellite WWTP is assumed to be 0.5 MGD such that a baseline flow equal to annual minimum day flows is processed at the satellite facility. Sizing for annual minimum day flows reduces the amount of days per year that the process operates with excess capacity. It is assumed that solids and brine will be returned to the force main for treatment at BBARWA's existing WWTP along with any sewage flows in excess of 0.50 MGD. The collection system between the Lake Pump Station and the WWTP will need to be evaluated to assess whether the reduced flows would impact the ability to adequately convey solids to the WWTP. The volume of recycled water produced for beneficial use could range from 500 to 520 AFY, depend on the portion of the flows that receive advanced treatment, as discussed later in this section.

As discussed in Section 4.2.3.1, the anticipated recharge capacity of the Sand Canyon site is 750 AFY, so the limiting factor is the volume of recycled water that can be produced at the satellite WWTP.

5.1.3.1 **Treatment Upgrades**

For Alternative 3, a new satellite WWTP would be constructed near BBARWA's existing Lake Pump Station. The new treatment processes required for this alternative include:

1. Preliminary Treatment
2. Secondary and Tertiary Treatment. A Membrane Bioreactor (MBR) process is assumed.
3. Reverse Osmosis (RO)
4. Ultraviolet Advanced Oxidation (UV/AOP)
5. Brine Disposal

The combination of MBR, RO and UV/AOP is considered a conventional indirect potable reuse treatment train. This treatment train meets the criteria in the DDW Regulations Related to Recycled Water (Title 22, Article 5.2). One of the issues with the RO process is that the TDS removed from the feed water is concentrated into a brine stream that needs to be disposed of.

A PFD for Alternative 3 is shown in Figure 5-8. The new facilities required for this alternative are outlined in blue. Additional detail on each of the treatment systems is provided in Appendix F.

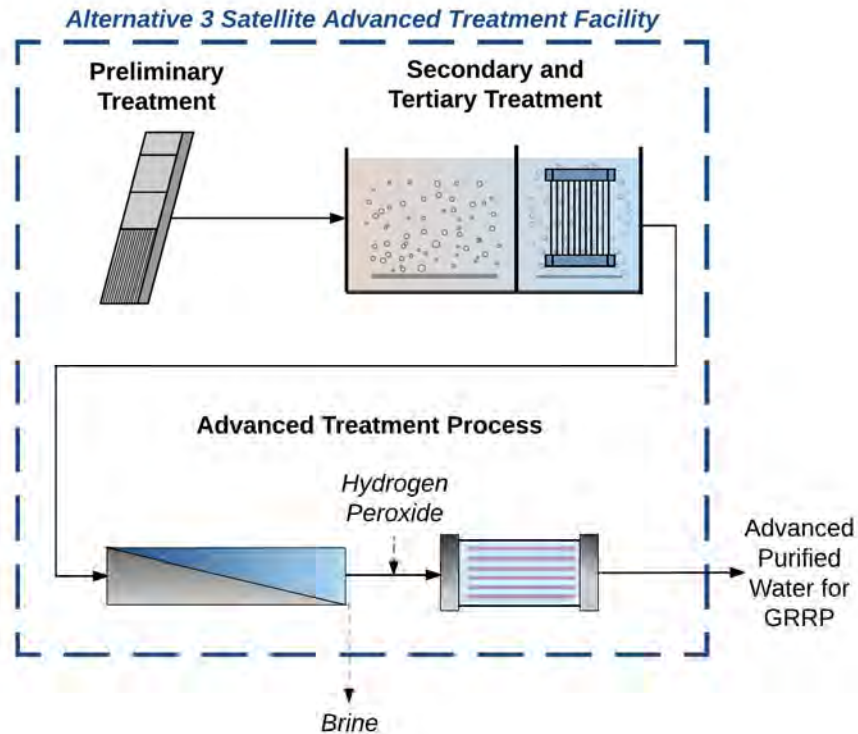

Figure 5-8. Treatment Process Flow Diagram for Alternative 3

5.1.3.1.1 Advanced Treatment Blending Considerations

As discussed in Section 3.3.1, there are two primary factors that influence the requirement for advanced treatment: the RWC and the water quality objectives for the beneficial use location.

The prior studies regarding evaluating recharge at the Sand Canyon Site did not address underflow at this location so a range of potential underflow values is considered for this alternative to provide a range of treatment costs. The 2012 United States Geological Survey (USGS) Geohydrology Report estimates the total recharge for the Rathbone subbasin to be 1,100 to 1,200 AFY (17). As a range of potential underflows, if 200 AFY is available for dilution credit, ~70% advanced treatment would be required; if 900 AFY is available for dilution credit, ~45% advanced treatment would be required to meet the 80% blend requirement and achieve an initial RWC requirement of 20%, as shown in Table 5-7. The 45% value was selected as a representative scenario to align with the RO treatment ratio required to meet the Basin Plan objective for TDS (discussed in the following paragraph) to provide a low range cost for this alternative.

Table 5-7 Water Sources for Alternative 3 Groundwater Recharge

Water Source	High Range Treatment Cost		Low Range Treatment Cost	
	Contribution, AFY	Contribution, % of Total	Contribution, AFY	Contribution, % of Total
Tertiary RW	140	20%	285	20%
Advanced Purified Water	360	51%	235	17%
Underflow	200	29%	900	63%
Total	700	100%	1,420	100%

The assimilative capacity for TDS in the Big Bear Valley Groundwater Management Zone has not been determined; however, recent water quality samples taken at BBLDWP’s nearby wells showed an average TDS concentration greater than the Basin Plan objective for TDS of 300 mg/L. Therefore, it is assumed that there is no assimilative capacity for TDS. To meet the TDS objective of 300 mg/L, 45% of the flows would need to be treated with RO to comply with the Basin Plan.

For Alternative 3, a range of advanced treatment requirements was evaluated to provide bookends based for treatment costs based on a range of advanced treatment blends to meet dilution and TDS removal requirements. The high range cost for this alternative is based on 70% advanced treatment and 30% tertiary treatments. The low range cost for this alternative is based on 45% advanced treatment and 55% tertiary treatment. This is the minimum advanced treatment that could be required to achieve TDS removal and would require a significant underflow credit of 750 AFY. A simplified PFD representing this blending scenario is shown in Figure 5-9.

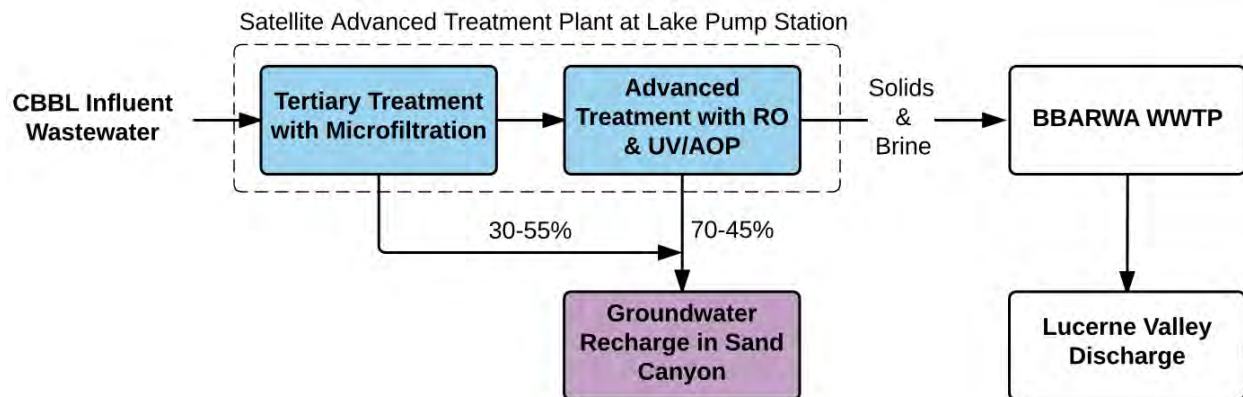

Figure 5-9. Treatment Process Flow Diagram Summarizing Blending Options for Alternative 3

5.1.3.2 Distribution System & Recharge Facilities

Approximately 17,400 ft of 8-in pipeline is required to convey the recycled water to the Sand Canyon Recharge Site, as well as a 310-320 gpm pump station at the new satellite WWTP.

The Sand Canyon Recharge Site is assumed to require 2.5 acres of recharge area based on the recommendation in the 1991 GEOSCIENCE evaluation (14).

Alternative 3 includes construction of 2 monitoring wells that will be used to collect groundwater samples to monitor water quality in the area. The water recharged in this alternatives is assumed to be produced by existing BBLDWP extraction wells downgradient of the recharge site.

The location of the facilities required for Alternative 3 are shown in Figure 5-10.

5.1.3.3 Operational Requirements

It is estimated that the operation and maintenance of the treatment and distribution upgrades for Alternative 3 will require an additional 2 FTE. The labor costs associated with the operations are included in the Annual O&M costs presented in Section 5.1.3.4.

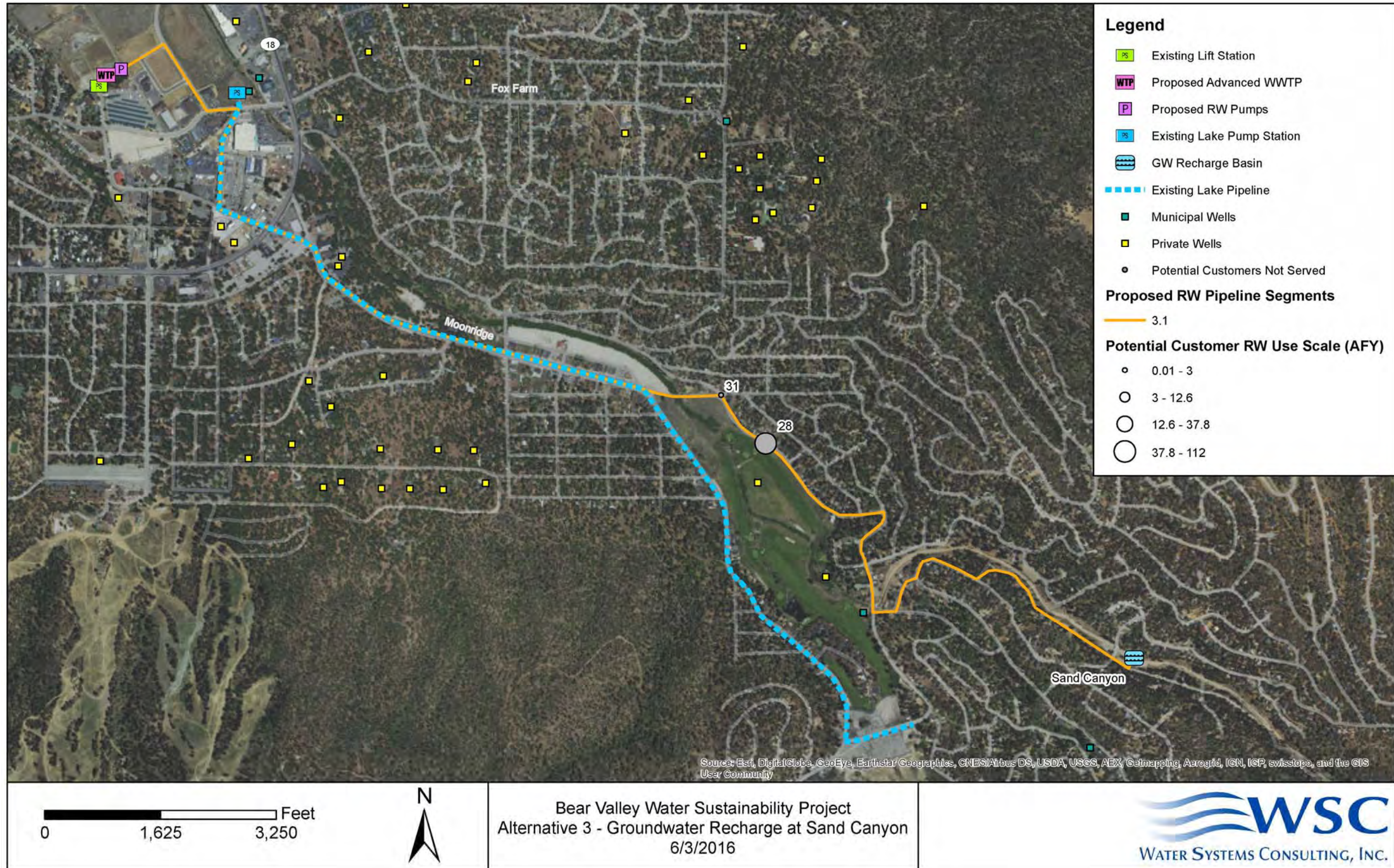

Figure 5-10. Alternative 3 Overview

5.1.3.4 **Unit Cost**

The range of unit costs for Alternative 3 is shown in Table 1-1, based on the range of advanced treatment requirements. Itemized costs estimates are included in Appendix G.

Table 5-8. Unit Cost for Alternative 3

Treatment Scenario	Total Capital Cost	Annual O&M	Unit Cost (\$/AF)
70% Advanced 30% Tertiary	\$24,315,000	1,259,000	\$4,750
45% Advanced 55% Tertiary	\$23,255,000	\$1,174,000	\$4,310

5.1.3.5 **Advantages and Disadvantages**

Alternative 3 provides 500-520 AFY of recycled water yield and retains approximately 25% of the available treated effluent in the Valley.

Alternative 3 includes the construction of a satellite WWTP at the Lake Pump Station and would require BBARWA to operate a second remote treatment facility.

Recharge at the Sand Canyon site has been evaluated in the past to confirm the feasibility of recharge at this site. Determination of the underflow credit using a groundwater model will be needed to confirm the advanced treatment volume required to meet RWC blending requirements.

The Sand Canyon channel serves as a flood control channel so all modifications and operations would need to be coordinated with and approved by the flood control agency. This adds some complexity to the implementation but is it expected to be technically feasible to use the channel for both artificial recharge and flood control.

BBLDWP’s existing Sand Canyon and Lake Plant wells are downgradient of the Sand Canyon recharge site and can produce water for use in BBLDWP’s Big Bear Lake and Moonridge systems, which are the two largest systems. BBLDWP can also provide water to BBCCSD through an existing interconnection.

Consistent recharge in the Sand Canyon stream would likely help stabilize Rathbun Creek underflows and may benefit the Lake by helping maintain more consistent flows in Rathbun Creek, which is tributary to the Lake.

5.1.3.6 **Potential Refinements**

There is an existing pipeline that runs from a pump station near the Lake to the Big Bear Mountain Resorts that provides Lake water for snowmaking and firefighting purposes. If this pipeline were used as a dual purpose to convey recycled water to the Sand Canyon site, the length of new pipeline required would be reduced by 9,700 ft. This would result in a cost savings of approximately \$150/AF. However, the shared use of this pipeline may not be compatible with the operational requirements for both uses, and coordination with the Big Bear Mountain Resort would be required to assess the feasibility of this operation. Note that, Mammoth Resorts recently purchased the Big Bear Mountain Resorts and potential operational changes may affect water uses.

5.1.4 **Alternative 4: Groundwater Recharge at Greenspot & Sand Canyon**

Alternative 4 includes tertiary and advanced treatment upgrades to BBARWA's existing WWTP for production of both disinfected tertiary and advanced purified water for groundwater recharge at the Greenspot & Sand Canyon Recharge Sites. The anticipated recharge capacity is 1,750 AFY total, with 1,000 AFY at Greenspot and 750 AFY at Sand Canyon.

5.1.4.1 **Treatment Upgrades**

Alternative 4 requires tertiary and advanced treatment upgrades to BBARWA's WWTP. Based on historical effluent water quality data, it is assumed the existing primary and secondary treatment facilities at the BBARWA WWTP will produce secondary effluent suitable for tertiary filtration. The secondary effluent from the existing WWTP would be fed to the advanced treatment process train consisting of:

1. Microfiltration/ultrafiltration (MF/UF)
2. Reverse Osmosis (RO)
3. Ultraviolet Advanced Oxidation (UV/AOP)
4. Brine Disposal

As previously stated, this conventional IPR treatment train meets the criteria in the DDW Regulations Related to Recycled Water (Title 22, Article 5.2).

It is assumed the brine disposal management strategy for Alternative 4 will be identical to the brine disposal management strategy proposed for Alternative 2 described in Section 5.1.2.1. As previously noted, this brine disposal method must be re-evaluated following issuance of a WDR Order TDS limit for effluent discharge to the LV Site.

A PFD for Alternative 4 is shown in Figure 5-11. The new facilities required for this alternative are outlined in blue. Additional detail on each of the treatment systems is provided in Appendix F.

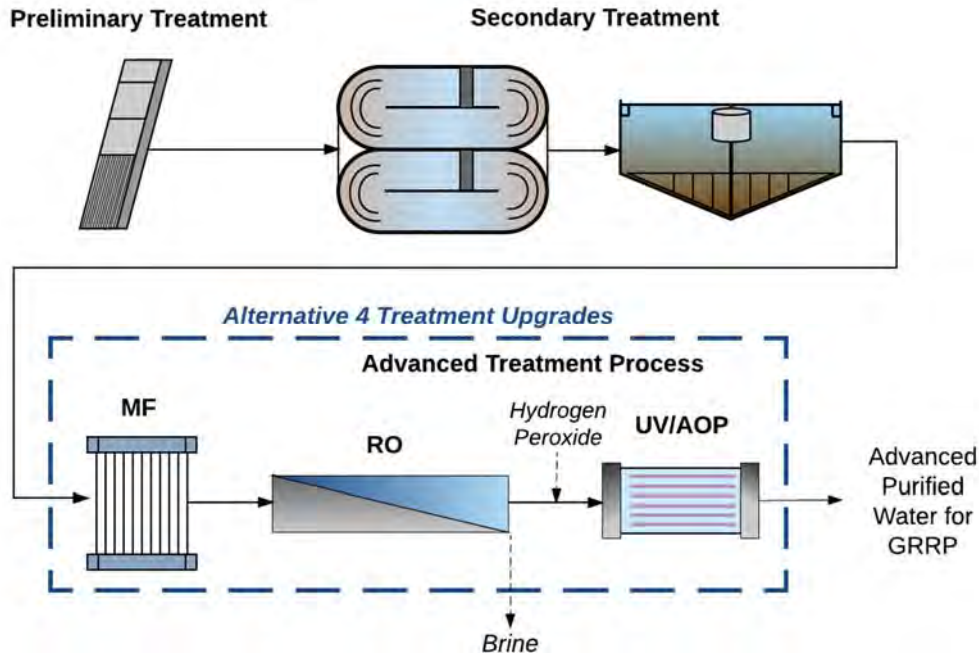

Figure 5-11 Treatment Process Flow Diagram for Alternative 4

5.1.4.1.1 Advanced Treatment Blending Considerations

Sections 5.1.2.1.1 and 5.1.3.1.1 provide an overview of the advanced treatment blending requirements for the Greenspot and Sand Canyon Sites based on results from prior studies and groundwater modeling analysis. For Alternative 4, it is assumed the underflow credit is 100 AFY at Greenspot and 200 AFY at Sand Canyon. The most stringent blending requirement of the two recharge sites governs the tertiary and advanced RW blending requirements and treatment capacities; this is done to avoid constructing duplicate facilities needed to store, pump and convey two different RW blends to each site. For the combined recharge project at Greenspot and Sand Canyon, the 22% Tertiary/78% Advanced blending requirement for Greenspot is required to meet the initial 20% RWC requirement at each recharge site. A simplified PFD representing this blending scenario is shown in Figure 5-12.

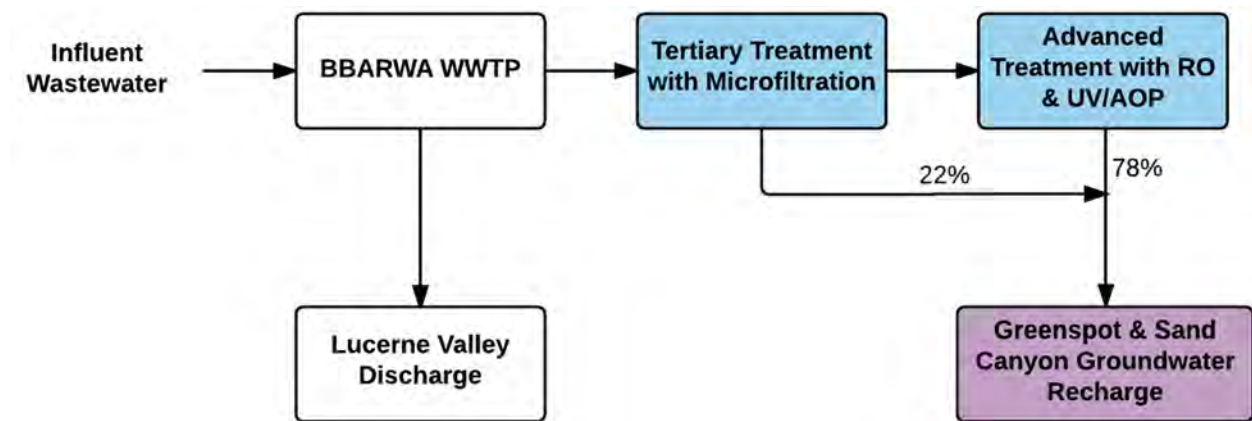

Figure 5-12 22% Tertiary/78% Advanced Treatment Process Flow Diagram for Alternative 4

5.1.4.2 Distribution System & Recharge Facilities

Approximately 50,200 ft of 12-in pipeline is required to convey the RW from the BBARWA WWTP to both recharge sites (approximately 16,200 ft to Greenspot and 34,000 ft to Sand Canyon). A new 1.6 MG storage tank and a pump station would also be constructed on the BBARWA WWTP site for storage and conveyance to the recharge ponds. The pump station would require pumps with capacities of approximately 615 gpm and 475 gpm to convey RW to Greenspot and Sand Canyon, respectively. The alignment and configuration of the distribution system can be optimized based on the final flow and head requirements of the distribution and recharge facilities.

The Greenspot Recharge Site is assumed to be a 7-acre site to allow more than five acres of area for surface water spreading, plus the necessary additional land for berms and maintenance access. The Sand Canyon Site is assumed to be a 2.5-acres based on the results from prior studies (14).

This alternative includes the addition of 6 extraction wells downgradient of the Greenspot recharge site to effectively intercept the water that is artificially recharged. These wells are assumed to have a pumping capacity of 100 gpm each. Water recharged at Sand Canyon is assumed to be produced by existing BBLDWP extraction wells downgradient of the recharge site. It is assumed 2 monitoring wells will be added at each recharge site for groundwater sample collection.

The location of the facilities required for Alternative 4 are shown in Figure 5-13.

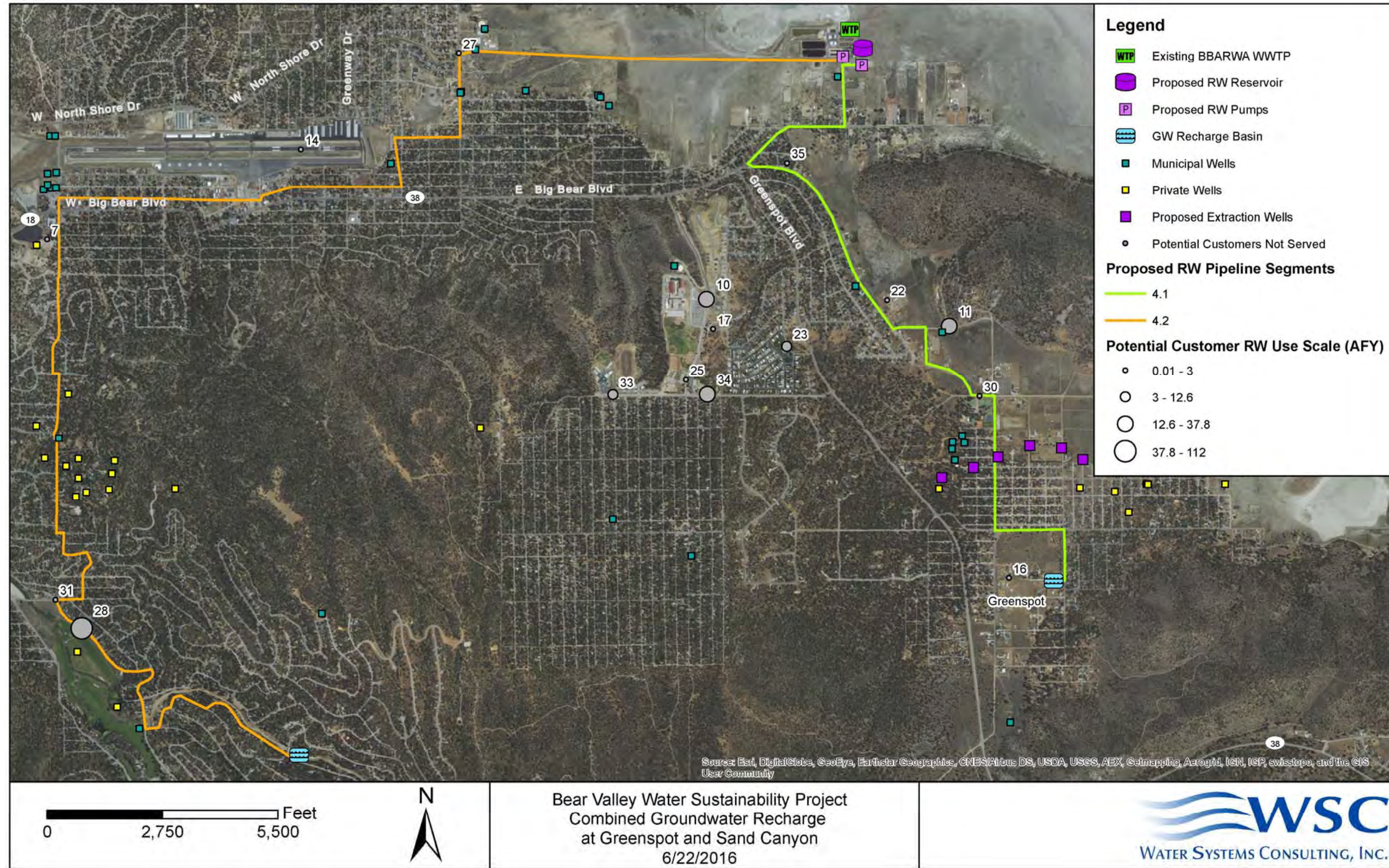

Figure 5-13 Alternative 4 Overview

5.1.4.3 **Operational Requirements**

It is estimated that the operation and maintenance of the treatment and distribution upgrades for Alternative 4 will require an additional 2 FTE. The labor costs associated with the operations are included in the Annual O&M costs presented in Section 5.1.2.4.

5.1.4.4 **Unit Cost**

The unit cost for Alternative 4 is shown in Table 5-9. Itemized costs estimates are included in Appendix G.

Table 5-9. Unit Cost for Alternative 4

Total Capital Cost	Annual O&M	Unit Cost (\$/AF)
\$69,700,000	\$2,726,000	\$3,390

5.1.4.5 **Advantages and Disadvantages**

Alternative 4 has the lowest unit cost of all the alternatives and it retains all the available RW in the Valley. The use of both recharge sites provides recharge in separate areas of the basin and provides some additional operational flexibility.

The key advantages to utilizing the Greenspot Recharge Site for an IPR application are discussed in Section 5.1.2.5. Most notably, the Greenspot site has been evaluated through extensive site-specific testing and it has been shown to have favorable recharge characteristics.

However, as stated in Section 5.1.2.5, the Greenspot Recharge Site would present some operational challenges for BBCCSD and BBLDWP. Both agencies would need to shift their production to the Erwin subunit to reclaim the recharge water and closely coordinate production well operations to ensure elevated groundwater levels do not hinder recharge potential at the site.

Prior studies have shown the Sand Canyon recharge site has soils ideal for recharge and percolation rates are sufficient to yield 750 AFY of recharge capacity. As described in Section 5.1.3.5, BBLDWP's existing Sand Canyon and Lake Plant wells are downgradient of the Sand Canyon recharge site and can produce water for use in BBLDWP's Big Bear Lake and Moonridge systems, which may be delivered to BBCCSD through an existing interconnection.

The main disadvantage to recharge at Sand Canyon is that it would have to serve as a flood control channel and a recharge basin, creating complexities in operational strategies and seasonal flood control management in the area.

Consistent recharge in the Sand Canyon stream would likely help stabilize Rathbun Creek underflows and may benefit the Lake by helping maintain more consistent flows in Rathbun Creek, which is tributary to the Lake.

5.1.4.6 Potential Refinements

Although Alternative 4 has the lowest unit cost of the alternatives considered, it also has the greatest capital cost. To potentially reduce the initial capital investment, a demonstration scale recharge project at Greenspot and a phased Alternative 4 project were considered as potential refinements to Alternative 4. These project refinements would reduce the technical, managerial and financial complexity of implementing Alternative 4 in one phase. The cost summaries for the potential refinement to Alternative 4 are included in Table 5-10 and the required facilities are described in the following subsections.

Table 5-10 Cost Summary for Potential Refinements to Alternative 4

Alternative	Capital Cost	O & M Cost	Recycled Water Yield, AF	Unit Cost, \$/AF	Net Present Value
Greenspot Phase 1	\$26,058,000	\$746,000	440	\$4,410	\$47,120,000
Greenspot Demonstration	\$5,133,000	\$590,000	50	\$16,520	\$22,254,000

Although the reduced scale of a demonstration scale or phased project provides an economic benefit of reduced capital expenditures, implementation of a phased construction project includes inherent risks. Phased expansion of WWTPs can result in the procurement of different products for the identical unit process which creates operational complexity. Similarly, changing personnel between phases can lead to alternative design approaches and result in differing operational requirements for identical unit processes. Careful consideration would have to be placed on maintaining consistent design practices, asset nomenclature and proposed operational procedures to minimize the design and construction risks associated with a phased project.

5.1.4.6.1 Greenspot Phase 1

The first potential refinement consists of phasing the construction of the project by implementing a recharge project at Greenspot to yield 25% of the total Alternative 4 beneficial use yield, or approximately 440 AFY. Of the two recharge sites, Greenspot is closer to the BBARWA WWTP and its hydrogeological conditions are well understood. The phased project assumes the same brine management strategy, RW blending requirements and underflow credits, as previously stated for Alternative 4.

For the phased approach to Alternative 4, 16,200-ft of 12-in. pipeline, a 275 gpm pump station and a 0.40 MG onsite RW storage tank are required to convey the RW to Greenspot. The 12-in. pipeline to Greenspot would have sufficient capacity to deliver the remainder of the Greenspot recharge capacity once additional phases of the project are implemented. Assuming the same blending requirements (22% tertiary/78% advanced) and 100 AFY of underflow credits, the tertiary and advanced treatment systems would be sized for 0.45 MGD and 0.36 MGD, respectively. To artificially recharge 440 AFY, only 3.5-acres of the Greenspot recharge site would need to be developed and it is assumed that 3 new production wells would be used to recover the water. It is assumed 2 monitoring wells would be sufficient for groundwater sampling.

The 25% capacity target for the first phase is intended to reduce capital costs while maintaining an appreciable beneficial use yield to provide a measurable water supply benefit (440 AFY is equivalent to roughly 10-15% of the Big Bear Valley's potable water demand). The 440 AFY capacity was also selected to allow for more manageable modular expansions of the tertiary and advanced treatment systems, which can be expanded upon with identically sized facilities at 25% increments until full capacity is reached.

It is estimated the operation and maintenance of the facilities associated with a phased Alternative 4 implementation would require 1.5 FTE.

This phased approach to implementation of Alternative 4 significantly reduces the capital cost required to initiate an artificial recharge project in the Valley. The unit cost of the RW would be high for the first phase of implementation; however, the facilities constructed in the first phase would remain in use during latter phases, which will reduce the unit cost as facility capacity is increased in the future.

5.1.4.6.2 Demonstration Recharge Project at Greenspot

Demonstration projects are common in the water-wastewater industry because they provide an opportunity for community education, establish proof of concept and promote local buy-in of the project. The Greenspot recharge site is close to schools in the Big Bear Valley, offering great educational opportunities for teaching students the value of water and the science behind artificial groundwater recharge. The small scale also gives operators the opportunity to learn about IPR processes and monitoring requirements with smaller facilities, which are more easily managed than full-scale systems.

The demonstration project includes purchasing a skid-mounted tertiary and advanced treatment system and delivering RW to the demonstration Greenspot recharge site using water tanker trucks. Deferring the construction of a 12-in pipeline to the Greenspot site would save approximately \$5 million in capital costs and \$32,000 in annual O&M of the pipeline. It is assumed the low volume of the brine stream from the advanced treatment system would not require volume reduction through brine treatment processes, saving another \$17 million in capital costs.

The treatment system would be sized to provide a RW yield of 50 AFY. Assuming two operators would operate 8,000-gallon capacity water trucks to transport RW to the Greenspot Site 5 days a week for 39 weeks out of the year (9-month recharge schedule), the advanced treatment system would need to produce approximately 80,000 gpd. The appropriate proportions of tertiary and advanced treated water will be treated at the existing BBARWA WWTP and blended in an onsite recycled water tank. A fill station with a small booster pump would be constructed near the recycled water tank for the water trucks to collect the recharge water. For this short term, small scale demonstration project, it is assumed that the brine could be blended with secondary effluent and delivered to the Lucerne Valley Site for irrigation water. As the capacity of the advanced treatment system and the groundwater recharge facilities increase with future expansions, the brine management strategy would shift to effluent mixing coupled with brine reduction and evaporation ponds, as described in Section 5.1.2.1 for Alternative 2.

The demonstration Greenspot Recharge Site is assumed to be 0.7-acres to allow for more than 0.5-acres of area for surface water spreading and sufficient space for maintenance access and berms. It is assumed 1 extraction well with 100 gpm capacity will be constructed downgradient of the Greenspot Recharge Site. To avoid the stranded assets in future expansions of the project, this well would have 100 gpm capacity to be consistent with the full-scale recharge application. As recharge volume increases in later phases of the project, the remaining five wells would need to be constructed.

In addition to the 2 FTE water truck operators, it is estimated that 0.75 FTE are required for operation and maintenance of the advanced treatment systems and the recharge facilities. The capacity selected for the advanced treatment plant and the recharge facility must align with manufacturer specifications for skid-mounted advanced treatment systems. Also, the quantity of water delivered to the recharge site is dependent on the size of the water tank truck and the staffing available for operation of the truck.

Due to the small size and skid mounted design of the demonstration scale treatment equipment, it may be difficult to incorporate this equipment into a future larger scale expansion of the treatment system, resulting in two separate treatment systems, or possibly the abandonment of the demonstration scale equipment. While minimizing the initial capital investment, this scenario does not provide significant improvements that can be easily expanded for future phases.

5.2 NON-RECYCLED WATER ALTERNATIVE

BBLDWP previously evaluated a supplemental water supply concept to provide imported water to the Valley. In June 2005, Camp Dresser & McKee, Inc. (CDM) prepared a cost estimate for a pipeline from Lucerne Valley to Big Bear Lake by way of the Morongo Pipeline. In a previous report by CDM from December 2004, it was determined that the most cost-effective path for the pipeline was along Highway 18. It was assumed that 1,000 AFY of water would be conveyed to the Valley for the purposes of estimating costs for imported water purchase, treatment plant capital and operation and maintenance costs, and the pipeline and booster pumps capital and operation and maintenance costs. For the purposes of comparison in this study, the capital and O&M costs assumed in the CDM analysis were escalated to the cost basis of this Study. The estimated unit cost for this imported water concept is \$5,630/AF. However, the Big Bear Agencies do not currently have supply contracts with any State Water Contractors and it may not be possible to secure them. Additionally, State Water Project water deliveries have declined in recent years and are subject to further reductions based on environmental and hydrologic factors. An imported water supply would not be a sustainable or drought proof supply for the Valley.

5.3 NO PROJECT ALTERNATIVE

The No Project Alternative would not require any upgrades to the BBARWA WWTP and the secondary effluent would continue to be discharged outside of the Valley for crop irrigation in the Lucerne Valley. The No Project alternative would not provide any benefits to the Valley.

5.4 WATER CONSERVATION/REDUCTION ANALYSIS

In order to meet conservation targets and the recent drought mandates, BBLDWP and BBCCSD have pursued multiple water use efficiency measures and actions, including water use restrictions and multiple water conservation incentive programs. The current Demand Management Measures implemented by each agency are summarized in Table 5-11. As shown in Figure 2-2, water demands have declined significantly since 2013 as a result of these conservation efforts.

Table 5-11 Demand Management Measures Implemented by BBLDWP and BBCCSD

Retail Agency Demand Management Measure	BBLDWP Measures (4)	BBCCSD Measures (8)
Water Waste Prevention Ordinances	Water Conservation Program Policy No. 2014-02 includes several indoor and outdoor water waste prevention policies.	Ordinance No. 2016-05 imposes water waste prohibitions for increasingly stringent water-supply shortage stages
Metering	Initiated Advanced Metering Infrastructure project to better track water system demands in real time and measure the effects of conservation measures.	Currently, all water services are metered and Ordinance Nos. 29 and 4S were enacted to declare foals pertaining to water meters
Conservation Pricing	Applies tiered rate structure to encourage minimization of water use.	Applies tiered rate structure to encourage minimization of water use.
Public Education and Outreach	Conducts water supply and conservation public education through local newspapers, social media and radio advertisements and manages a Xeriscape Demonstration Garden to provide ideas for residential drought tolerant landscape.	Conducts water conservation education and outreach through public water conservation awareness program and sponsors the local Xeriscape Demonstration Garden.
Distribution System Real Loss Management Program	The DWP conducts regular mass balance audits of metered water production versus metered water sales to detect unusual changes in the water operation, and performs hydraulic modeling to identify existing system deficiencies.	Staff performs regular inspections or contracts leak detection companies to check for system leaks. Completed AWWA Water Audit for 2015.
Water Conservation Program Coordination	Employs one full-time staff person as Water Conservation and Public Information Specialist and one part-time Water Conservation Technician to manage the responsibilities of the water conservation program.	BBCCSD’s conservation program is managed by the Water Department Superintendent with support from Water Department Staff. The shared responsibilities are equivalent to a full-time conservation coordinator’s responsibilities
Other	Offers indoor conservation consults/audits, landscape surveys, turf buyback programs and provides rebates to customers for performing high efficiency appliance retrofits	Reviews effectiveness of demand management measures by continually observing water production and usage. Educational outreach directed at younger customers to encourage continued future water conservation.

Outdoor water use conservation measures would reduce the irrigation demands that could be served with recycled water under Alternative 1. This would result in a lower potable water offset and a higher cost per AF of recycled water put to beneficial use.

Indoor water use conservation measures would reduce wastewater generation and would result in a lower recycled water production volume that can be put to beneficial use for groundwater recharge alternatives; this may result in a higher cost per AF of recycled put to beneficial use.

Implementation of private greywater systems would decrease wastewater generation, as well as water consumption. BBLDWP estimated 600 AFY would be saved if their customers used greywater to irrigate their landscaping (4). While greywater systems provide an opportunity to increase the sustainable use of resources, widespread implementation in the Big Bear Valley would have an impact on the volume and strength of wastewater available for future reuse projects. The greatest barrier to implementation of greywater systems in existing buildings is the user conversion costs. Greywater system conversions require plumbing modifications inside and outside the building and construction of a treatment system. Typically, greywater systems are implemented at sites with new construction where the treatment system and plumbing connections are constructed concurrently with the structure.

5.5 ALTERNATIVES ANALYSIS

5.5.1 Qualitative Evaluation Criteria

Each alternative was screened using the following qualitative screening criteria:

- Promotes Beneficial Management of Water Resources
- O&M Complexity
- Ease of Implementation
- Benefit to the Valley Community

Each criterion has a corresponding scoring approach. The scoring approaches and definition of each criterion are provided in Appendix H. The scoring approach was then weighted based on the importance of the criteria to the project’s goals and objectives. For each alternative, the weighted score for the screening criteria was summed to find the qualitative total. Finally, each alternative was ranked based on the qualitative score total.

5.5.2 Quantitative Analysis Summary

Each alternative was compared based on unit cost and recycled water yield. Table 5-12 summarizes the results from the quantitative comparison. For the purposes of the alternatives evaluation, only Segment 1.1 of Alternative 1 was included because it has the lowest unit cost and does not rely on highly uncertain customers such as the gold course. For Alternative 3, the Low Range cost was included in the evaluation for simplicity, although the High Range cost would not change the overall ranking.

Table 5-12. Recycled Water Alternatives Quantitative Analysis Summary

Alternative	Alternative 1 Irrigation (Segment 1.1)	Alternative 2 Greenspot	Alternative 3 Sand Canyon (Low Range)	Alternative 3 Sand Canyon (High Range)	Alternative 4 Greenspot & Sand Canyon
Total Capital Cost	\$3,257,000	\$44,533,000	\$23,255,000	\$24,315,000	\$69,700,000
Annual O&M Cost	\$65,000	\$1,539,000	\$1,174,000	\$1,259,000	\$2,726,000
Recycled Water Yield (AFY)	54	1,000	520	500	1,750
Unit Cost (\$/AF)	\$3,960	\$3,580	\$4,310	\$4,750	\$3,390
Net Present Value	\$5,087,000	\$88,172,000	\$56,759,000	\$60,247,000	\$147,270,000

5.5.3 Alternative Ranking Criteria and Scoring Results

For the alternative analysis, each alternative was compared and ranked on the basis of qualitative criteria, beneficial use yield and unit cost. Each alternative received a ranking between 1 and 3. The ranking system is summarized in Table 5-13.

Table 5-13. Alternative Ranking Criteria

Criteria	Ranking of 1	Ranking of 3
Qualitative	Lowest weighted score	Highest weighted score
Unit Cost	Lowest Unit Cost	Highest Unit Cost
Water Available for Beneficial Use	Largest Recycled Water amount used	Smallest Recycled Water amount used

As shown in Figure 5-14, Alternative 4 ranked first in the two of the three alternative ranking criteria categories and highest overall; therefore, Alternative 4 was selected as the top ranked alternative. Alternative 1 ranked the lowest.

5.5.4 Preferred Alternatives

Alternative 4 was highest ranked and is recommended for implementation as the ultimate project, although it can be implemented in phases over time. At full scale, Alternative 4 would beneficially use nearly all of the treated effluent within the Valley.

Qualitative/Non-Economic Criteria	Assigned Scores (1, 2 or 3; 3 being the best)				Weighting Factors (1-4, 4 being most important)	Weighted Scores (Assigned Scores x Weighting Factors)			
	Alternative 1 (Segment 1.1)	Alternative 2	Alternative 3 (Low Range)	Alternative 4		Alternative 1 (Segment 1.1)	Alternative 2	Alternative 3 (Low Range)	Alternative 4
Promotes Beneficial Management of Water Resources	1	2	3	3	3	3	6	9	9
O&M Complexity	3	2	2	1	2	6	4	4	2
Ease of Implementation	3	1	1	1	1	3	1	1	1
Benefit to Bear Valley Community	1	2	2	3	4	4	8	8	12
Total (Non-Economic/Qualitative)	8	7	8	8		16	19	22	24

Quantitative Criteria	Alternative 1 (Segment 1.1)	Alternative 2	Alternative 3 (Low Range)	Alternative 4
Capital Cost	\$3,257,000	\$44,533,000	\$23,255,000	\$69,700,000
Annual O&M	\$65,000	\$1,539,000	\$1,174,000	\$2,726,000
Beneficial Use Yield (AFY)	54	1000	520	1750
Unit Cost (\$/AF)	\$3,960	\$3,580	\$4,310	\$3,390

Ranking	Alternative 1 (Segment 1.1)	Alternative 2	Alternative 3 (Low Range)	Alternative 4
Qualitative/Non-Economic	4	3	2	1
Beneficial Use Yield (AFY)	5	2	3	1
Unit Cost (\$/AF)	2	1	3	3
Overall Rank	4	2	3	1

Figure 5-14. Alternative Evaluation Results

6 RECOMMENDED FACILITIES PROJECT PLAN

As discussed in Section 5.5, Alternative 4 was ranked the highest and is the recommended alternative for implementation. There is sufficient treated effluent available to provide RW for artificial recharge at both Greenspot and Sand Canyon.

As described in Section 5.1.4.6, a demonstration scale or phased project may be considered for the Alternative 4 implementation. Greenspot has been thoroughly studied and modeled; therefore, there is little risk in establishing the Greenspot site to initiate the Valley's RW program. A phased approach to implementing 25% of the Valley's potential RW use yield sets the agencies up for modular expansion to eventually reuse all the potential RW, while maintaining all assets for use in later phases. Due to the low beneficial use yield of the demonstration project and the likelihood for stranded assets due to the small scale, it is recommended the agencies pursue a phased Alternative 4 project rather than a demonstration scale project if the potential refinements to Alternative 4 were to be considered.

6.1 RECYCLED WATER YIELD

The potential recycled water yield of Alternative 4 is summarized in Table 6-1.

Table 6-1. Summary of Alternative 4 Recycled Water Yield

Alternative	Potential Water Use, AFY
Alternative 4 – Greenspot & Sand Canyon Recharge	1,750

6.2 TREATMENT IMPROVEMENTS

A portion of the flow will require advanced treatment to meet recycled water blending requirements and to comply with groundwater quality objectives. The advanced treatment process train would consist of:

1. MF/UF
2. RO
3. UV/AOP
4. Brine Disposal

The combination of MF, RO and UV/AOP is considered the conventional indirect potable reuse treatment train.

The brine stream generated from the RO process in Alternative 4 would be treated and disposed of using effluent mixing coupled with brine reduction and evaporation ponds at the LV Site. Alternatively, the Project Team has expressed an interest in exploring the concept of constructing brine storage and evaporation ponds on the BBARWA WTP site to avoid the cost of the brine pipeline to the LV Site. As previously stated, this brine management strategy must be reevaluated following issuance of the new LV Site TDS limit. The issuance of the TDS limit will occur after the approval of the TDS study, which is due to the State Board by December 31, 2017.

The treatment capacity of Alternative 4 is summarized in Table 6-2.

Table 6-2. Treatment Capacity Summary for Alternative 4

Alternative	Tertiary Treatment		Advanced Treatment		Total Blended Water Produced, MGD
	Capacity, MGD	% of Total Recharge Water	Capacity, MGD	% of Total Recharge Water	
Alternative 4: Greenspot & Sand Canyon Recharge	1.78	22%	1.43	78%	1.56

6.3 RECHARGE AND DISTRIBUTION IMPROVEMENTS

Alternative 4 requires construction of an onsite storage tank, a water truck fill station and recharge facilities. A summary the improvements is presented in Table 6-3. A map of Alternative 4 is shown in Figure 6-1.

Table 6-3. Alternative 4 Facilities Summary

Facility	Capacity
Storage, MG	1.56
Pump Station, gpm	1,100
Pipeline (length, ft/dia)	50,200 / 12"
Recharge Basin, acres	9.5
New Extraction Wells	6
New Monitoring Wells	4

6.4 COST ESTIMATE

The cost estimate for Alternative 4 is summarized in Table 6-4.

Table 6-4. Cost Summary for Alternative 4

Alternative	Capital Cost	O & M Cost	Recycled Water Yield, AF	Unit Cost, \$/AF	Net Present Value
Alternative 4: Greenspot & Sand Canyon Recharge	\$69,700,000	\$2,726,000	1,750	\$3,390	\$147,936,000

The SWRCB Water Recycling Funding Program received funding from the 2014 California Water Bond (Prop 1) and is currently offering grant funding for water recycling projects. This grant program, which is described in more detail in Section 8.2.1, is offering 35% grants, with a maximum grant amount of \$15,000,000. To illustrate the benefits of this grant program, Table 6-5 summarizes the local portion of the project costs if a 35% grant is received to reduce the local capital contribution.

Table 6-5. Cost Summary Including 35% Grant for Alternative 4

Alternative	Capital Cost	O & M Cost	Recycled Water Yield, AF	Unit Cost, \$/AF	Net Present Value
Alternative 4: Greenspot & Sand Canyon Recharge	\$45,305,000	\$2,726,000	1,750	\$2,750	\$124,180,000

There may be opportunities to leverage other grant funding programs, such as the USDA Rural Development Water and Environment Program, to further reduce the portion of project costs that must be funded locally.

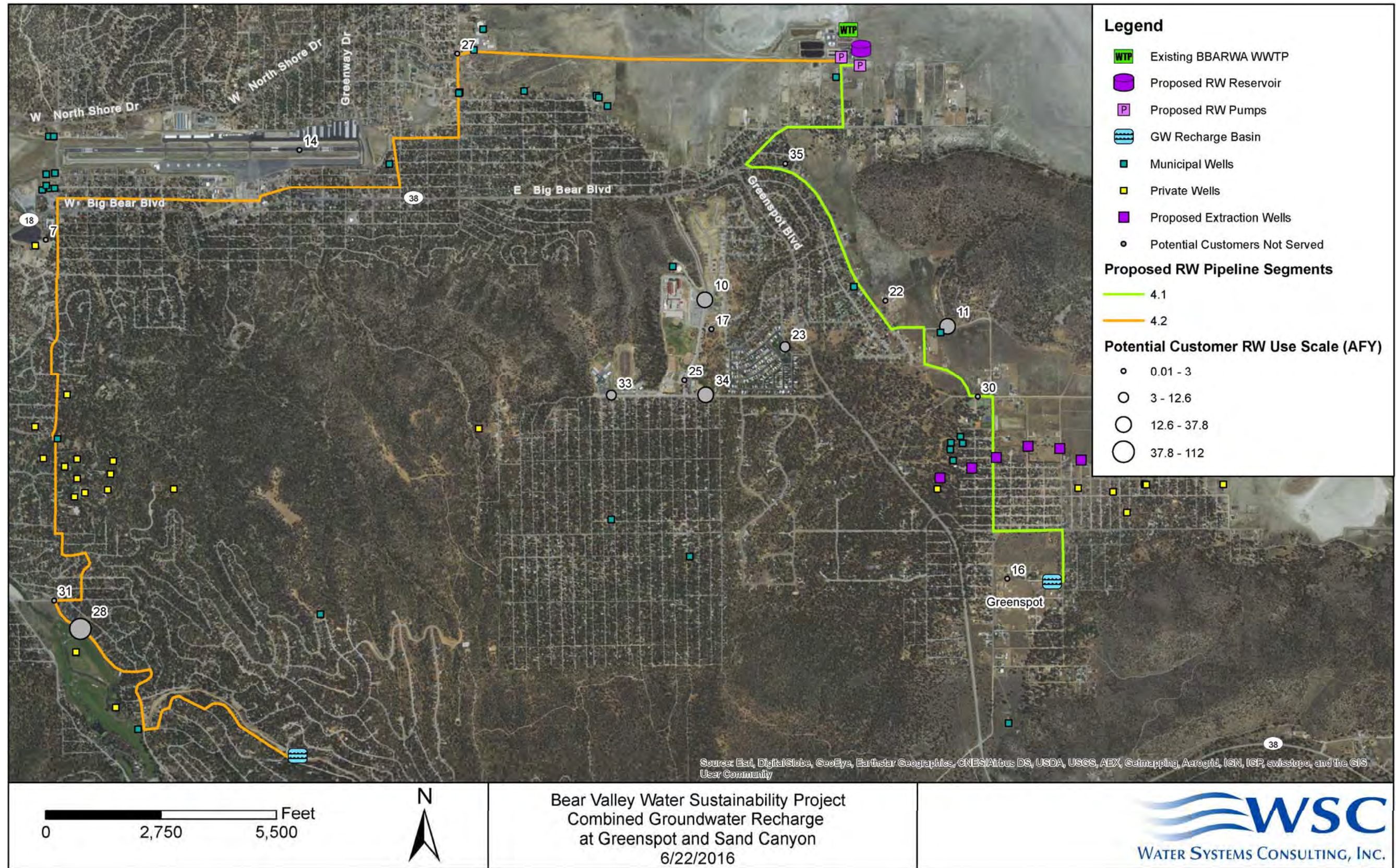

Figure 6-1. Alternative 4 Overview

7 IMPLEMENTATION PLAN

This Chapter describes what the Project Team will need to consider and address when implementing the selected recycled water project(s).

7.1 NEXT STEPS FOR IMPLEMENTATION

The next steps towards the implementation of the recommended groundwater recharge projects are summarized below. The next steps apply to both the Greenspot and Sand Canyon recharge projects unless otherwise stated.

- Quantify dilution credit
 - Sand Canyon Site will require a complete hydrogeologic analysis in order to quantify credits
 - Greenspot Site will require an update to the prior hydrogeologic analysis using the existing groundwater model
- Coordinate with the SAWPA BMPTF to assess assimilative capacity for TDS
- Perform a brine analysis for the Sand Canyon recharge alternative to confirm whether brine generated at the satellite facility could be discharged to the BBARWA plant without impacting the ability to meet discharge requirements
- Target optimization of brine management at the existing BBARWA WWTP by evaluating:
 - alternative treatment technologies for a portion of the advanced treatment to minimize brine produced
 - new and emerging technologies that could reduce brine disposal costs
 - local brine evaporation scenarios and sites
- Perform additional field investigations and perform groundwater model analysis for the Sand Canyon Site to explore operational scenarios and the impact on groundwater levels and travel time
- Perform additional modeling for the Greenspot Recharge Site to further explore operational scenarios and validate the number of new production wells needed.
- Public outreach to enhance public engagement and support for the project
- Outreach to public universities and Water Environment & Reuse Foundation to discuss potential partnering opportunities for inland potable reuse research.
- Establish monitoring system for funding program solicitations related to demonstration recycled water projects.

7.2 PERMITTING REQUIREMENTS

7.2.1 Tentative Water Recycling Requirements of the Santa Ana RWQCB

In order to implement the recommended recycled water projects, BBARWA will need to initiate a permit reopener and renewal process with the Santa Ana RWQCB to obtain coverage for the proposed advanced treatment upgrades, waste effluent discharge and recharge. BBARWA will need to submit a Report of Waste Discharge to the Santa Ana RWQCB and an Engineering Report to Santa Ana RWQCB and DDW. The Engineering Report will need to include:

- Description of the proposed advanced treatment at the WWTP
- A hydrogeological assessment of the proposed Groundwater Replenishment Reuse Project (GRRP's) setting, including:
 - a general description of geologic and hydrogeological setting of the groundwater basin(s) potentially directly impacted by the GRRP;
 - a detailed description of the stratigraphy beneath the GRRP, including the composition, extent, and physical properties of the affected aquifers; and
 - based on at least four rounds of consecutive quarterly monitoring to capture seasonal impacts:
 - the existing hydrogeology and the hydrogeology anticipated as a result of the operation of the GRRP
 - maps showing quarterly groundwater elevation contours, along with vector flow directions and calculated hydraulic gradients.
- A map of the GRRP site showing (1) the location and boundaries of the GRRP; (2) a boundary representing a zone of controlled drinking water well construction based on required retention times, (3) a secondary boundary representing a zone of potential controlled drinking water well construction, depicting the zone within which a well would extend the boundary in paragraph (2) to include existing or potential future drinking water wells, thereby requiring further study and potential mitigating activities prior to drinking water well construction; and (4) the location of all monitoring wells and drinking water wells within two years travel time of the GRRP based on groundwater flow directions and velocities expected under GRRP operating conditions
- Justification of the required Response Retention Time and a protocol to be used to establish the required retention times
- A protocol describing the actions to be taken following construction of the upgrades to demonstrate that all treatment processes have been installed and can be operated to achieve their intended function
- Demonstration that the project sponsor possesses adequate managerial and technical capability to assure compliance with the regulations
- An emergency response plan for an alternative source of potable water supply or treatment at a drinking water well if the GRRP causes the well to no longer be safe for drinking purposes
- A contingency plan which will assure that no untreated or inadequately-treated wastewater will be delivered to the use area

Water recycling requirements for the GRRP will be in accordance with the Groundwater Recharge Regulations and are anticipated to include the requirements presented in Table 7-1. Figure 7-1 illustrates the anticipated Santa Ana RWQCB permitting process required.

Table 7-1. Tentative Water Recycling Requirements

Element	Surface Recharge
Treatment	RO and AOP treatment to meet blending and/or Basin Plan requirements
Retention time	Minimum 2 months
Recycled Water Max Initial Contribution (RWC _{max})	Up to 100% with RO and AOP
Total Nitrogen	Average < 10 mg/L
Total Organic Carbon (TOC)	< 0.5 mg/L
Monitoring Wells	2 monitoring wells down gradient of the GRRP

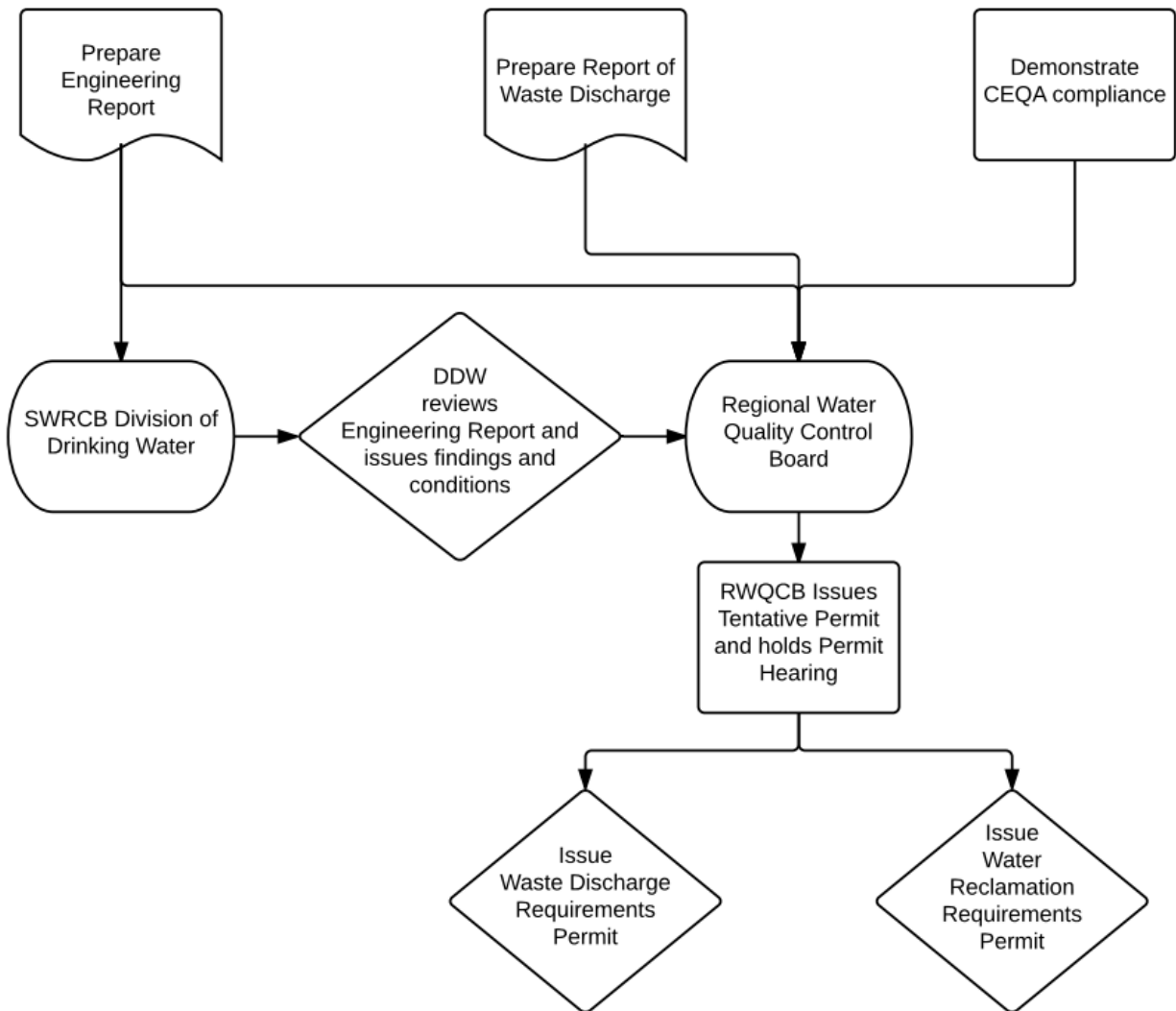

Figure 7-1. Permitting Process

Prior to the operation of the GRRP, the Project Team will also be required to develop and implement the following:

- An industrial pretreatment and pollutant source control program and maintain a source control program. As a component of the source control program, an outreach program to industrial, commercial, and residential communities discharging to the WWTP will be needed for the purpose of managing and minimizing the discharge of chemicals and contaminants at the source.¹
- An Operation Optimization Plan which identifies and describes the operations, maintenance, analytical methods and monitoring necessary for the GRRP to meet the requirements of the Groundwater Recharge Regulations.

7.2.2 Infrastructure Permits

It is anticipated that the Project Team will need to obtain multiple permits to construct the recommended projects including, but not limited to, the following:

- Caltrans encroachment permits for pipeline with Caltrans Right-of-Way
- The City of Big Bear Lake and/or San Bernardino County encroachment permits for improvements within their Rights-of-Way
- Grading permits for treatment upgrades, recharge basins, and extraction well sites
- NPDES General Construction Permit
- Building permits
- Authority to Construct and Permit to Operate the WWTP upgrades from the South Coast Air Quality Management District

7.3 ENVIRONMENTAL DOCUMENTATION REQUIREMENTS (CEQA)

In accordance with the California Environmental Quality Act (CEQA), it is anticipated the Project Team will prepare an Initial Study (IS) followed by an Environmental Impact Report (EIR) for the recommended project. In anticipation of applying for federal funding sources, the Project Team may also prepare an Environmental Assessment (EA) and an Environmental Impact Statement (EIS) to comply with the National Environmental Policy Act (NEPA).

¹ It is anticipated BBARWA's existing Ordinances No. 69 & O.03-2002 may be used to demonstrate compliance with the requirements of both programs.

7.4 BENEFICIARIES

The beneficiaries of this project include potable water customers of the BBLDWP, BBCCSD and private well pumpers in the Valley. The potable water users benefit from a new source of supply which is local, sustainable and highly reliable, even in times of drought.

Wastewater disposal for the BBARWA's wastewater customers is currently being achieved effectively through treatment and discharge to the Lucerne Valley Site for crop irrigation; therefore, the wastewater customers are not considered a beneficiary of this project. Although no significant near term changes are anticipated to the Colorado WDR that regulates this discharge, it is foreseeable that water quality and resulting treatment requirements will become more stringent in the future as more constituents are regulated and/or detection levels are lowered. In this situation, the wastewater customers would also receive benefits from the treatment upgrades proposed by the recommended project.

7.5 COORDINATION AND GOVERNANCE

It is recommended the Project Team continue discussions with each other regarding funding, financing and cost sharing for subsequent planning and design activities as well as fixed and variable project costs.

7.6 PUBLIC OUTREACH

Depending on the relative public acceptability of a GRRP, there may be a need for a public information program, which could take many different forms. It is recommended that the Project Team engage in a proactive public outreach program in coordination with other existing or planned outreach programs.

8 CONSTRUCTION FINANCING PLAN AND ANNUAL OPERATING BUDGET

Planning a recycled water program and building recycled water infrastructure requires a significant upfront capital investment. Additionally, adequate funding for annual O&M is necessary to ensure successful operation. Developing and implementing a recycled water program will require the project partners to develop a sound financial plan.

It is anticipated that the project will be funded through a combination of grants, low interest loans, cost-sharing contributions from the Project Team, and potentially other mechanisms.

8.1 ANNUAL OPERATING BUDGET

Table 8-1 summarizes the potential annual capital payment (based on 100% loan) and O&M costs for the recommended recharge projects.

Table 8-1. Estimated Project Annual Cost

	Greenspot & Sand Canyon Recharge
Annual Capital Payment	\$ 3,198,000
Annual O&M Cost	
Pipeline	\$ 100,000
Storage	\$ 20,000
Pump Station Maintenance	\$ 37,000
Pump Station Power	\$ 111,300
Tertiary Treatment	\$ 226,000
Advanced Treatment	\$ 994,000
Brine Management System	\$ 1,113,000
Compliance for Recycled Water	\$ 76,250
Recharge Basin	\$ 48,000
Total Annual O&M	\$ 2,726,000
Total Annual Cost	\$ 5,924,000

8.2 FUNDING OPPORTUNITIES

Pursuing project funding will require an upfront investment by the Project Team, and grant funding is anticipated to be highly competitive. The recommended recycled water project is anticipated to be attractive to grant funding agencies because it meets several objectives commonly prioritized by funding programs, including:

- Relies upon and strengthens local and regional partnerships
- Develops a new, local, sustainable water supply that benefits regional communities
- Improve water supply reliability
- Improves groundwater basin quality

The following sections present potential grant and loan funding opportunities that may be available for the project, including the recently approved 2014 California Water Bond (Prop 1).

8.2.1 Grant and Loan Programs

Funding opportunities for recycled water projects are available from several state and federal sources, including the SWRCB, Department of Water Resources (DWR), United States Bureau of Reclamation (USBR), USDA, California Energy Commission (CEC), and the U.S. Environmental Protection Agency (EPA). Several of these programs are responsible for administering the funds made available by the 2014 Water Bond (Prop 1). Funding programs are available to fund project activities from preliminary planning to construction. A summary of eligible funding programs is presented in Table 8-2.

Table 8-2. Eligible Funding Programs

Funding Program	Applicability to BVWSP	Available Funding	Project Deadlines	DAC Eligibility	Application Schedule	Reimbursable Funds Prior to Start Date	Required Documents
WFRP- Construction Grant/Loan Program	Funding for construction of water recycling projects	Grants up to 35% up to maximum of \$15 million. Loans/financing available for 100% of eligible costs. Repayment term up to 30 years. Interest rate is set to half of the most recent General Obligation bond rate.	Total eligible project capacity shall be delivered within 5 calendar years of operation from the date of Initiation of Operations 50% of eligible project capacity must serve existing users	A small DACs may receive up to 40% in grants up to \$20 million ¹	Applications are accepted on a continuous basis	The applicant may satisfy the local match requirement through other sources, including its own revenues, for example, where it has incurred and paid costs for studies and other directly associated planning and design incurred prior to the grant award date	CEQA
CWSRF- Wastewater Treatment Projects and Recycling Funding	Low interest financing for wastewater treatment facilities. Construction of publically owned treatment facilities. Wastewater treatment, local sewers, sewer interceptors, water reclamation, storm water treatment, combined sewers	30-year financing term at interest rate set to half of the most recent General Obligation bond rate ²	No specific project timeline. Projects prioritized by "Readiness to proceed"	No preference/requirement for DAC	Applications are accepted on a continuous basis	Applicants may start construction prior to the effective date of the financing agreement, but will not receive reimbursement of construction costs incurred prior to the effective date, and are not guaranteed financing approval and an executed financing agreement.	CEQA+
USDA Rural Development- Water & Waste Disposal Loan & Grant Program	Funding for acquisition, construction or improvement of sewer collection, transmission, treatment and disposal facilities.	Up to 40-year financing term with fixed interest rates dependent on median household income and need for project. State or local match of 25% required. Grants may be combined with loans.	No specific project timeline.	DAC preferred/no requirement for DAC. Financing terms dependent on community MHI.	Applications are accepted on a continuous basis	Any costs including design, engineering during construction, construction, legal fees and land acquisition incurred prior to the date of award must be submitted to the USDA in writing to be considered for reimbursement.	NEPA
USBR WaterSMART Water and Energy Efficiency Grant	Project can demonstrate a benefit to an endangered threatened species, and reduce water and energy consumption. Would support alternatives for groundwater recharge	Funding Group I: Up to \$300,000 up to two years. Funding Group II: Up to \$1,500,000 up to three years	2 Years for Funding Group I. 3 Years for Funding Group II	No preference/requirement for DAC	Deadline has passed for 2016 grants. Application released between October-December, and due approximately 3 months after release date. Applicants should receive funding by summer of the following year	Any costs including design, construction plans, environmental compliance costs incurred prior to the date of award may be submitted for consideration for reimbursable expense	NEPA
USBR WaterSMART Title XVI Water Reclamation and Reuse Program	Funding for construction of projects that reclaim and reuse. Reclaimed water can be used for a variety of purposes such as environmental restoration, fish and wildlife, groundwater recharge, municipal, domestic, industrial, agricultural, power generation, or recreation	Financing for construction projects is less than \$20 million or 25% of total project cost. Funding for projects approved by congress and sponsored by congressman. 6 years since last construction authorization.	Typically, 24-36 months to complete tasks in agreement ⁵	No preference/requirement for DAC	Deadline has passed for 2016 grants. Application released between October-December of this year. Applications due approximately 3 months after release date. Applicants should receive funding by summer of the following year	Any costs including design, construction plans, environmental compliance costs incurred prior to the date of award may be submitted for consideration for reimbursable expense	NEPA
USBR WaterSMART Title XVI Water Reclamation and Reuse Program	Funding for planning/feasibility study for recycled water project. Reclaimed water can be used for a variety of purposes such as environmental restoration, fish and wildlife, groundwater recharge, municipal, domestic, industrial, agricultural, power generation, or recreation	Federal share for 50% of Feasibility Study	Typically, 18 months to complete tasks in agreement ³	No preference/requirement for DAC	Deadline has passed for 2016 grants. Applications likely to be released in January of 2016	Any costs including design, construction plans, environmental compliance costs incurred prior to the date of award may be submitted for consideration for reimbursable expense	NEPA
Integrated Regional Water Management (IRWM) - Implementation Grant Program	Provides funding for implementation projects that support integrated water management	Minimum local funding match of 25%	No specific time to completion listed. Project must be implementation ready to apply for funding	MHI<80% of Statewide annual MHI	Deadline has passed for 2016 grants. Applications for 2017 likely to be due August 2016, and awarded January 2017	Reimbursable funds after effective date are for engineering, design, land and easement, legal fees, preparation of environmental documentation, environmental mitigation, and project implementation. Grant application preparation prior to effective date is reimbursable	CEQA
I-Bank Infrastructure State Revolving Fund	Provide financing for infrastructure and economic development projects	\$50,000 - \$25 million. Most recent interest rates between 2-3%	No specific time to completion listed. Project must be implementation ready to apply for funding	No DAC requirement; staff may adjust interest rate based on factors including MHI on a case by case basis	Continuous application process		CEQA

Notes:

1. Eligible communities include those with a population <20,000. Disadvantaged Communities (DAC) are those with MHI<80% of Statewide MHI. Severely DACs are those with MHI<60%.
2. Current CWSRF interest rate is 1.7%, 10 year range of 2.5% to 3%. No funding limit.
3. Extensions are allowed on a case-by-case basis.

9 CONCLUSIONS AND RECOMMENDATIONS

The implementation of a Bear Valley Water Sustainability Project that retains highly treated water in the Valley for beneficial use would provide a sustainable and drought proof source of supply that would support current and future residents and businesses long into the future. However, even with taking advantage of current funding programs, such a project would represent a significant investment for the community. The costs and long term benefits to the community should be carefully considered when determining the timing for implementation of the Bear Valley Water Sustainability Project.

Key next steps towards the implementation of the recommended groundwater recharge project were identified in Section 7.1. At a minimum, it is recommended that the Project Team consider the following two activities to continue to build a foundation for the potential future implementation of a groundwater recharge project.

- Coordinate with the SAWPA BMPTF regarding the assimilative capacity assessment process for TDS and consider adding the Big Bear Valley Groundwater Management Zone to the periodic update process.
- Continue public outreach to enhance public engagement and support for a groundwater recharge project in the Valley.

10 REFERENCES

1. **Big Bear Municipal Water District** . In-Lieu Program. *BBMWD Lake Management*. [Online] 2016. [Cited: June 1, 2016.] <http://www.bbmwd.com/programs-projects/in-lieu-progam/>.
2. **Engineering Resources**. *Big Bear Area Regional Wastewater Agency 2010 Sewer Master Plan*. 2010.
3. **Tom Dodson & Associates**. *Draft Program Environmental Impact Report for the Big BEar Area Regional Wastewater Agency's Recycled Water Master Plan*. 2005.
4. **Carollo**. *2015 Urban Water Management Plan for the City of Big Bear Lake Department of Water and Power*. 2016.
5. **Big Bear Municipal Water District** . Historical Lake Level/Precipitation. *BBMDW Lake Management*. [Online] 2016. [Cited: May 27, 2016.] <http://www.bbmwd.com/historical-lake-level-precipitation/>.
6. **National Oceanic and Atmospheric Administration**. Climate Data Online. *National Centers for Environmental Information*. [Online] [Cited: May 27, 2016.] <https://www.ncdc.noaa.gov/cdo-web/>.
7. **CDM**. *City of Big Bear Lake Department of Water and Power Water Master Plan*. 2006.
8. **Water Systems Consulting**. *2015 Urban Water Management Plan for Big Bear City Community Services District*. 2016.
9. **GEOSCIENCE Support Services, Inc.** *Technical Memorandum - Perennial Yield Update for the City of Big Bear Lake Department of Water and Power Service Area*. 2006.
10. **Big Bear Lake Department of Water and Power**. *2015 Annual Consumer Confidence Report for Big Bear, Moonridge, Fawnskin, Lake William, Sugarloaf and Erwin Lake Water Systems* . 2015.
11. **Big Bear City Community Services District**. *2015 Annual Water Quality Report*. 2015.
12. **Big Bear Area Regional Wastewater Agency**. *2017 Budget*. 2017.
13. **GEOSCIENCE Support Services, Inc.** *Geohydrologic Evaluation of Artificial Recharge Potential in the Big Bear Valley, California*. 2004.
14. —. *Geohydrologic Evaluation of Artificial Recharge Potential of the Sand Canyon Area*. 1991.
15. **Engineering Resources of Southern California, Inc.** *Proposed Recycled Water Project "A View to the Future" Engineers Report Pursuant to Section 60323 Title 22, California Code of Regulations*. November 1998.
16. **Lozier, James C., et al.** *Evaluating Traditional and Innovative Concentrate Treatment and Disposal Methods for Water Recycling at Big Bear Valley, California*. 2005.

17. **U.S. Department of the Interior, U.S. Geological Survey.** *Geohydrology of Big Bear Valley, California; Phase 1 - Geological Framework, Recharge, and Preliminary Assessment of the Source and Age of Groundwater.* 2012. Scientific Investigations Report 2012-5100.
18. **Wildermuth Environmental, Inc.** *Recomputation of Ambient Water Quality in the Santa Ana Watershed for the Period 1993-2012.* 2014.
19. **Association for the Advancement of Cost Engineering, Inc.** *AACE International Recommended Practice No. 17R-97; Cost Estimate Classification System; TCM Framework: 7.3 - Cost Estimating and Budgeting;.* 2011.
20. **Big Bear Lake Department of Water and Power.** *Revenue Requirement Analysis.* 2013.
21. **WSC.** *Technical Memorandum - Cost Estimate for BBARWA Tank Cost.* 2015.

Appendix A. WDR R7-2016-0026 and WDR R8-2005-004

CALIFORNIA REGIONAL WATER QUALITY CONTROL BOARD
COLORADO RIVER BASIN REGION

BOARD ORDER R7-2016-0026

WASTE DISCHARGE REQUIREMENTS
FOR
BIG BEAR AREA REGIONAL WASTEWATER AGENCY, OWNER/OPERATOR
EXPORT OF RECYCLED WATER TO LUCERNE VALLEY
Lucerne Valley – San Bernardino County

The California Regional Water Quality Control Board, Colorado River Basin Region (Colorado River Basin Water Board) finds that:

1. Big Bear Area Regional Wastewater Agency (BBARWA or Discharger), P. O. Box 517, Big Bear City, California 92314, owns 480 acres in the Lucerne Valley, of which 340 acres are irrigated with recycled water from the Discharger's Wastewater Treatment Plant (WWTP). There are an additional 140 acres available for irrigation, also in the Lucerne Valley. BBARWA's WWTP provides sewerage service to the City of Big Bear Lake, Big Bear City Community Services District, and County Service Area 53-B. The WWTP is located at 122 Palomino Drive, Big Bear City, California 92314, and has a design treatment capacity of 4.89 million gallons-per-day (MGD) and a hydraulic capacity of 9.2 MGD.
2. The WWTP is located outside the boundary of the Colorado River Basin Water Board and is regulated by the California Regional Water Quality Control Board, Santa Ana Region (Santa Ana Water Board) under Waste Discharge Requirements (WDRs) Order R8-2005-0044.
3. The WWTP consists of: preliminary treatment, secondary treatment, and sludge drying and treatment. Secondary treated wastewater from the WWTP is disposed through three possible discharge points that are designated in Board Order R8-2005-0044 as Point 001, Point 002 and Point 003. The discharges from the WWTP at Points 002 and 003 are regulated by the Santa Ana Water Board. Most of the treated wastewater is discharged through Discharge Point 001 into the Lucerne Valley to irrigate fodder, fiber, and seed crops.
4. This Board Order regulates the discharge from the WWTP at Point 001. Infrastructure associated with this discharge includes a concrete-lined reservoir and two overflow ponds that are used to dispose of treated recycled wastewater by percolation and evaporation in the Lucerne Valley (Lucerne Valley Facility) located on Assessor's Parcel Number (APN) 0449-082-040000.
5. The Lucerne Valley Facility has been subject to WDRs adopted in Colorado River Basin Water Board Order 01-156 adopted November 14, 2001.
6. The WDRs are being updated to comply with current laws and regulations as set forth in the California Water Code (CWC) and the California Code of Regulations (CCR) and to incorporate any changes in ownership or operation undertaken by the Discharger.
7. The Lucerne Valley Facility is assigned California Integrated Water Quality System (CIWQS) number CW- CW-208930; Waste Discharger Identification (WDID) number 7A360100011, and GeoTracker Global ID number WDR100027897.

Wastewater Treatment and Discharge

8. The Lucerne Valley Facility is located on 480 acres owned by BBARWA and located near the intersection of State Hwy 247 (Old Woman Springs Road) and Camp Rock Road in the Lucerne Valley of San Bernardino County in Section 14, Township 4 North, Range 1 East, San Bernardino Base & Meridian, as shown in Attachment A, Vicinity Map, incorporated herein, and made part of this Board Order by reference.
9. Wastewater that is discharged at the Lucerne Valley Facility goes through preliminary and secondary treatment at the WWTP before it is sent via gravity to the concrete reservoir at the Lucerne Valley Facility. The WWTP components that are used for treatment are described below:
 - a. Preliminary Treatment. Untreated wastewater flows to the preliminary treatment system, which consists of bar screens, aerated grit chamber with grit washer, and a flow bypass channel. This treatment stage removes screenings, rag material and grit.
 - b. Secondary Treatment. Effluent flows by gravity from the preliminary treatment system to three parallel oxidation ditches for secondary (biological) treatment and timed processes for nutrient (nitrogen) removal. The number of ditches in operation depends on the seasonal fluctuations of the influent flow. The effluent from the oxidation ditches flows into a system of three secondary clarifiers for removal of floatable and settleable solids/materials. The secondary treated effluent flows to two cement-lined balancing chambers and then flows to equalization storage ponds at the WWTP until pumped for offsite irrigation disposal. A process flow diagram of the WWTP is shown on Attachment B, incorporated herein, and made part of this Board Order by reference.
 - c. Offsite Irrigation/Disposal. Undisinfected secondary treated wastewater is pumped from the WWTP's main pump building (5.2 MGD) or auxiliary pump building (9.2 MGD) approximately 16.5 miles to an offsite 2.26-million gallon concrete-lined reservoir (undisinfected secondary recycled water reservoir). This reservoir is located one mile south of the irrigation site. Wastewater from the reservoir flows by gravity through an outfall line connected to the irrigation system. In the event of an overflow at the concrete-lined reservoir, the wastewater flows by gravity to earthen overflow ponds located adjacent to the irrigation site.
10. Approximately 2.01 MGD of undisinfected secondary recycled water (as defined in Title 22 California Code of Regulations Section 60301.900) is discharged to the Lucerne Valley Facility for irrigation of fodder and fiber crops. Undisinfected secondary wastewater has been approved by the California Department of Public Health (DPH) [now State Water Resources Control Board (SWRCB) Division of Drinking Water (DDW)] for irrigation use at this site. Approximately 340 acres are being irrigated at the Lucerne Valley Facility, with an additional 140 acres available for irrigation at the site. The effluent discharge limit of 4.8 MGD in this Board Order is based on the capacity of the irrigated crops to take up nitrogen. The Lucerne Valley Facility site layout is shown in Attachment C, incorporated herein, and made part of this Board Order by reference.
11. The SWRCB's Division of Drinking Water has established statewide reclamation criteria in Title 22 CCR Section 60301 et seq. for the use of recycled water and has developed guidelines for specific uses. Title 22 CCR Section 60304(d)(4) allows the use of undisinfected secondary recycled water for the surface irrigation of fodder and fiber crops and pasture for animals not producing milk for human consumption. BBARWA's Title 22

Engineering Report was initially approved on November 3, 1980, by the California DHS, (now DDW). The Title 22 report was last updated November 4, 1998, to allow for the use of tertiary treated wastewater in the Big Bear Area.

12. The grazing of sheep on the irrigation site has been allowed under certain conditions, as outlined in a letter from Colorado River Basin Water Board staff dated November 15, 1994, and under the conditions shown in Discharge Specification D.22 of this Order.
13. No sewage sludge is discharged at the recycled water reuse site.
14. BBARWA's Self-Monitoring Reports (SMRs) from April 2011 through March 2016 characterize the WWTP effluent as follows:

<u>Constituent</u>	<u>Units</u>	<u>Average</u>	<u>Maximum</u>	<u>Minimum</u>
Flow	MGD	2.01	4.18	1.42
20° C BOD ₅ ¹	mg/L ²	6	17	2
TSS ³	mg/L	13	48	5
pH	s.u. ⁴	7.8	8.0	7.4
TDS ⁵	mg/L	450	519	354
Nitrate as N	mg/L	3.5	21.6	0.1
Total Nitrogen	mg/L	6.9	28	1.9
Chloride	mg/L	52	61	34
Sulfate	mg/L	40	48	26
Fluoride	mg/L	0.37	0.54	0.24
Boron	mg/L	0.18	0.25	<0.1

Hydrogeologic Conditions at the Lucerne Valley Facility

15. BBARWA installed one groundwater monitoring well in 1979 and three more groundwater monitoring wells in 1991 (MW-1, MW-2 and MW-3). Monitoring well MW-3 replaced the 1979 monitoring well, which was never monitored because the groundwater level is below the bottom of the well. Previous monitoring did not require depth to groundwater monitoring; however, the Discharger's reports indicate that MW-1 is the upgradient well. This Board Order will require depth to groundwater monitoring in order to establish the groundwater gradient.

¹ 5-day biochemical oxygen demand at 20 degrees Celsius.

² milligrams per Liter

³ Total Suspended Solids

⁴ Standard pH units

⁵ Total Dissolved Solids

16. An irrigation well (14M1) was installed immediately northwest of the overflow ponds in 1986. The distance from well 14M1 to the nearest overflow pond is 180 feet.
17. BBARWA has reported that the depth to groundwater at the Lucerne Valley Facility is a minimum 150 feet below ground surface.
18. Groundwater monitoring data collected from monitoring wells MW-1, MW-2 and MW-3 during the period from 2009 to the present show the following average characteristics:

<u>Constituent</u>	<u>Units</u>	<u>MW-1</u>	<u>MW-2</u>	<u>MW-3</u>
Depth to Groundwater ⁶	ft	176	130	141
TDS	mg/L	464	718	619
Total Nitrogen	mg/L	10.6	16.2	17.6
Nitrate as Nitrogen	mg/L	9.4	15.6	17.2
Sulfate	mg/L	63.3	203	173
Chloride	mg/L	106	122	135
Fluoride	mg/L	0.25	0.14	0.25
Boron	mg/L	<0.01	<0.01	<0.01
VOCs – MTBE	ug/L	9.0	ND	ND
VOCs – Methylene Chloride	ug/L	ND	1.4	1.1
VOCs – Bromomethane	ug/L	ND	ND	1.3

19. An analysis of groundwater monitoring data in monitoring wells MW1, MW2 and MW3 from 2000 to the present indicates that concentrations for nitrate, sulfate and chloride are decreasing in the downgradient wells (MW2 and MW3) and increasing in the upgradient well (MW1). This Board Order will require that the Discharger submit a technical report providing an analysis of the water quality impacts by nitrogen and TDS to groundwater resulting from the discharge and to report annual trend monitoring of the data collected in the groundwater monitoring network. The monitoring frequency for total nitrogen and nitrate in the groundwater monitoring wells will be increased from annually to monthly for 12 months and quarterly thereafter to establish groundwater gradient and flow direction. In addition, this Board Order will require annual reporting of nitrogen application of fertilizers and in farming practices and provide a nitrogen and water use balance for the recycled water used on-site.
20. Annual precipitation in the Lucerne Valley region averages about 5.5 inches. Annual evapotranspiration rate is approximately 68 inches.
21. The project lies beyond the toe of a large alluvial fan emanating from the mouth of Cushenbury Canyon in the eastern portion of Lucerne Valley.

⁶ Measurement made in 2004.

22. There are several domestic wells in the vicinity of the on-site evaporation/percolation ponds.
23. Water supply to the Big Bear area communities is from numerous groundwater production wells located in Big Bear Valley. TDS in the water supply averages about 280 mg/L based on data reported in the BBARWA's SMRs from 2008 through 2015.
24. Regional groundwater flow in the irrigation and disposal area is generally to the northwest.
25. BBARWA conducted a geotechnical study referenced as *Geotechnical Study, Irrigation Site, Lucerne Valley Area, San Bernardino County, California for Big Bear Area Regional Wastewater Agency, July 29, 1977*, as an initial investigation of the site for use for irrigation. The report shows that the site is underlain by soils consisting of fine to coarse, clean to silty sands containing various amounts of gravel from 5 to 24 feet below ground surface. Beneath this, to a depth of 60 to 100 feet below ground surface, the soil consists of fine to medium silty sands containing varying amounts of gravel, and is locally cemented with calcium carbonate accumulated during deposition of the sediments. Bedrock underlies the older alluvium at a depth of 400 to 600 feet.

Basin Plan, Beneficial Uses, and Regulatory Considerations

26. The Water Quality Control Plan for the Colorado River Basin Region of California (Basin Plan), which was adopted on November 17, 1993, and amended on November 13, 2012, designates the beneficial uses of ground and surface waters in this Region, and contains implementation programs and policies to achieve water quality objectives, including narrative objectives for ground water quality, in Chapter 3, section IV, Ground Water Objectives.
27. The discharge is within the Lucerne Hydrologic Unit. The beneficial uses of groundwater in the Lucerne Hydrologic Unit include:
 - a. Municipal supply (MUN),
 - b. Industrial supply (IND), and
 - c. Agricultural supply (AGR).
28. These WDRs implement numeric and narrative water quality objectives for ground and surface waters established by the Basin Plan. The numeric objectives for groundwater designated for municipal and domestic supply are the maximum contaminant levels (MCLs) specified in sections 64431, 64444, and 64678 of Title 22 of the California Code of Regulations (CCR), and the bacteriological limits specified in section 64426.1 of Title 22, CCR.
29. It is the policy of the State of California that every human being has the right to safe, clean, affordable, and accessible water adequate for human consumption, cooking, and sanitary purposes. This order promotes that policy by requiring discharges to meet maximum contaminant levels designed to protect human health and ensure that water is safe for domestic use.
30. Section 13267 of the CWC authorizes the Colorado River Basin Water Board to require technical and monitoring reports. The Monitoring and Reporting Program (MRP) establishes monitoring and reporting requirements to implement federal and state

requirements.

31. This Order establishes WDRs pursuant to Division 7, Chapter 4, Article 4, of the CWC for discharges that are not subject to regulation under Clean Water Act (CWA) section 402 (33 U.S.C. section 1342).
32. Pursuant to CWC section 13263(g), the discharge of waste is a privilege, not a right, and adoption of this Order does not create a vested right to continue the discharge.
33. The discharge authorized by this Board Order, and treatment and storage facilities associated with discharges of treated municipal wastewater, except for discharges of residual sludge and solid waste, are exempt from the requirements of the Consolidated Regulations for Treatment, Storage, Processing, or Disposal of Solid Waste, as set forth in Title 27, CCR, Division 2, Subdivision 1. This exemption is based on section 20090(a) of Title 27, which states in relevant part that discharges of domestic sewage or treated effluent are exempt provided that such discharges are regulated by WDRs, or for which WDRs have been waived, and which are consistent with applicable water quality objectives, and treatment or storage facilities.

Groundwater Degradation

34. State Water Board Resolution 68-16, "Policy with Respect to Maintaining High Quality Waters of the State"(Resolution 68-16) states:

"Whenever the existing quality of water is better than the quality established in policies as of the date on which such policies become effective, such existing high quality will be maintained until it has been demonstrated to the State that any change will be consistent with maximum benefit to the people of the State, will not unreasonably affect present and anticipated beneficial use of such water and will not result in water quality less than that prescribed in the policies."

Resolution 68-16 further states:

"Any activity which produces or may produce a waste or increased volume or concentration of waste and which discharges or proposes to discharge to existing high quality waters will be required to meet waste discharge requirements which will result in the best practicable treatment or control [BPTC] of the discharge necessary to assure that (a) a pollution or nuisance will not occur and (b) the highest water quality consistent with maximum benefit to the people of the State will be maintained."

35. Some degradation of groundwater from the discharge to the evaporation/percolation ponds is consistent with Resolution 68-16, provided that the degradation:
 - a. Is confined to a reasonable area;
 - b. Is minimized by means of full implementation, regular maintenance, and optimal operation of BPTC measures;
 - c. Is limited to waste constituents typically encountered in domestic wastewater; and
 - d. Does not result in the loss of any beneficial use as prescribed in the applicable basin plan, or violation of any water quality objective.
36. The discharge of wastewater as permitted by Order R7-2016-0026 and Order R8-2005-

0044 reflects BPTC. The controls assure the discharge does not create a condition of pollution or nuisance, and that water quality will be maintained, which is consistent with the anti-degradation provisions of Resolution No. 68-16. The Discharger incorporates:

- a. A WWTP that provides treatment to secondary standards and nitrification/denitrification processes;
- b. An operation and maintenance manual;
- c. Staffing to assure proper operation and maintenance;
- d. A network of groundwater monitoring wells at the recycle site;
- e. A requirement for an Irrigation Management Plan; and
- f. A standby emergency power generator of sufficient size to operate the treatment plant and ancillary equipment during periods of loss of commercial power.

Accordingly, the discharge as authorized is consistent with the anti-degradation provisions of Resolution 68-16 and the applicable water quality objectives.

Constituents of Concern

37. Constituents in domestic wastewater effluent that present the greatest risk to groundwater quality are nitrogen, coliforms (pathogen-indicator organisms), and TDS. Recycled water used for irrigation at the Lucerne Valley Facility is treated to secondary standards and has undergone substantial removal of soluble organic matter, solids, and nitrogen treatment.
38. Title 22, CCR, section 64431, Maximum Contaminant Level (MCL) for Nitrate plus Nitrite as Nitrogen is 10 mg/L. To account for the fate of transport for the various components of Total Nitrogen, as a conservative value it is assumed that all nitrogen present converts to nitrate/nitrite. BBARWA's SMRs report an average of 6.9 mg/L for Total Nitrogen between April 2011 and March 2015. Prior to the operation of nitrification/denitrification processes at the WWTP, groundwater analyses at the irrigation and disposal site demonstrated degradation by nitrates. This Board Order will require the Discharger to provide a technical report in the form of a study that analyses the impacts to groundwater by the discharge and an evaluation of water quality trends. In addition, this Board Order will implement a monthly average effluent limitation of 10 mg/L for total nitrogen as a means to mitigate groundwater degradation.
39. While secondary treatment reduces fecal coliform densities by 90 to 99%, the remaining organisms in effluent are still 10^5 to 10^6 MPN/100 ml (United States Environmental Protection Agency, Design Manual, Municipal Wastewater Disinfection; October 1986). Given the depth to groundwater, it is not likely that pathogen-indicator bacteria will reach groundwater at densities exceeding those prescribed in Title 22, CCR.
40. The typical incremental addition of dissolved salts from domestic water usage is 150 to 380 mg/L. Domestic water supply to the Big Bear area communities showed an average concentration of about 280 mg/L during the period of 2011 to 2016. From April 2011 to March 2016 treated wastewater discharged had an average TDS concentration of approximately 450 mg/L. Thus, the average TDS increase over the domestic water supply in the discharge during the same time period was about 170 mg/L. Treated wastewater discharged by the WWTP has a TDS limit of a maximum of 400 mg/L above the domestic source water as regulated by Board Order 01-156. This Board Order will

require the Discharger to provide a technical report in the form of a study that analyzes the impacts to groundwater by the discharge and an evaluation of water quality trends. The results of the study will be used to establish an appropriate effluent limitation for TDS.

CEQA and Public Participation

- 41. In accordance with section 15301, Chapter 3, Title 14, CCR, the issuance of these WDRs, which govern the operation of an existing facility involving negligible or no expansion of use beyond that previously existing, is exempt from the provisions of the California Environmental Quality Act (CEQA, Pub. Resources Code, section 21000 et seq.).
- 42. The Colorado River Basin Water Board has notified the Discharger and all known interested agencies and persons of its intent to draft WDRs for this discharge, and has provided them with an opportunity for a public meeting and an opportunity to submit comments.
- 43. The Colorado River Basin Water Board, in a public meeting, heard and considered all comments pertaining to this discharge.

IT IS HEREBY ORDERED, that Board Order 01-156 is rescinded upon the effective date of this Order, except for enforcement purposes, and, in order to meet the provisions contained in Division 7 of the California Water Code, and regulations adopted thereunder, the Discharger shall comply with the following:

A. Effluent Limitations

- 1. Effluent discharged into the overflow evaporation/percolation ponds for disposal shall not exceed the following effluent limits:

<u>Constituent</u>	<u>Units</u>	<u>30-Day Arithmetic Mean</u>	<u>7-Day Arithmetic Mean</u>	<u>Daily Maximum</u>
20° C BOD ₅	mg/L	30	45	-----
Total Suspended Solids	mg/L	30	45	-----
Chloride	mg/L	60	-----	80
Sulfate	mg/L	60	-----	80
Boron	mg/L	-----	-----	0.75
Total Nitrogen	mg/L	10	-----	-----

- 2. The 30-day average daily dry weather discharge for irrigation shall not exceed 4.8 MGD.
- 3. Effluent discharge for irrigation shall not have a pH below 6.0 or above 9.0.

B. Groundwater Limitations

- 1. Discharge at the Lucerne Valley Facility shall not cause groundwater to:
 - a. Contain constituents in excess of California MCLs, as set forth in the California Code

of Regulations, Title 22, section 64426.1 for bacteriological constituents; section 64431 for inorganic chemicals; section 64444 for organic chemicals; and section 64678 for determination of exceedances of lead and copper action levels.

- b. Contain taste or odor-producing substances in concentrations that adversely affect beneficial uses as a result of human activity.

C. Discharge Prohibitions

1. Discharge of waste classified as “hazardous”, as defined in Title 23, CCR, section 2521(a), or “designated”, as defined in California Water Code section 13173, is prohibited.
2. Discharge of treated wastewater at a location other than the designated disposal areas or as recycled water used for irrigation at approved use areas, is prohibited.
3. The discharge of recycled water to any drainage courses or surface waters is prohibited.
4. Discharge of waste to land not owned or authorized for such use by the Discharger is prohibited.
5. Surfacing or ponding of wastewater outside of the designated disposal locations is prohibited.
6. Bypass, overflow, discharge, or spill of untreated or partially treated waste is prohibited.
7. Application recycled water and fertilizers containing nitrogen at a rate greater than the agronomic uptake rate of the crops grown is prohibited.

D. Discharge Specifications

1. The discharge shall not cause pollution or nuisance as defined in sections 13050(l) and 13050(m) of Division 7 of the California Water Code, respectively.
2. A minimum depth of freeboard of two (2) feet shall be maintained at all times in the overflow earthen basins and concrete-lined reservoir.
3. The overflow ponds shall be managed to prevent breeding of mosquitoes. In particular:
 - a. An erosion control program should assure that small coves and irregularities are not created around the perimeter of the water surface.
 - b. Weeds shall be minimized through control of water depth, harvesting, or herbicides.
 - c. Dead algae, vegetation, and debris shall not accumulate on the water
4. All storage and disposal areas shall be designed, constructed, operated, and maintained to prevent inundation or washout due to floods with a 100-year return frequency.
5. The overflow ponds shall have sufficient capacity to accommodate allowable wastewater flow, design seasonal precipitation, ancillary inflow, and infiltration during the non-irrigation season. Design seasonal precipitation shall be based on total

annual precipitation using a return period of 100 years, distributed monthly in accordance with historical rainfall patterns.

6. Public contact with non-disinfected wastewater shall be precluded through such means as fences, signs, and other acceptable alternatives. The non-disinfected wastewater is not approved for off-site distribution. Conspicuous signs shall be posted in a prominent location in each area where non-disinfected wastewater is stored on-site. Each sign or label with "Non-disinfected wastewater - No body contact or drinking" wording shall be displayed as well as the international warning symbol.
7. Objectionable odors originating at the Lucerne Valley Facility shall not be perceivable beyond the limits of the wastewater treatment and disposal area.
8. The overflow ponds and concrete-lined reservoir shall be maintained so they will be kept in aerobic conditions.
9. The dissolved oxygen content in the upper zone (one foot) of the concrete reservoir and overflow ponds shall not be less than 1.0 mg/L.
10. There shall be no surface flow of wastewater away from the designated disposal areas.
11. On-site wastes, including windblown spray from recycled water application, shall be strictly confined to the lands specifically designated for the disposal operation, and on-site irrigation practices shall be managed so there is no runoff of effluent from irrigated areas.
12. No irrigation with, or impoundment of, undisinfected secondary recycled water shall take place within 150 feet of any domestic water supply well.
13. No spray irrigation of any recycled water shall take place within 100 feet of a residence or a place where public exposure could be similar to that of a park, playground or schoolyard.
14. Except as allowed under Section 7604 of Title 17, California Code of Regulations, no physical connection shall be made or allowed to exist between any recycled water system and any separate system conveying potable water.
15. Undisinfected secondary recycled water, as defined in Title 22, Section 60301.900 is limited only for irrigation in the following applications:
 - a. Orchards where the recycled water does not come into contact with the edible portion of the crop,
 - b. Vineyards where the recycled water does not come into contact with the edible portion of the crop,
 - c. Non-food bearing trees (Christmas tree farms are included in this category provided no irrigation with recycled water occurs for a period of 14 days prior to harvesting or allowing access by the general public),
 - d. Fodder and fiber crops and pasture for animal not producing milk for human consumption,

- e. Seed crops not eaten by humans,
 - f. Food crops that must undergo commercial pathogen-destroying processing before being consumed by humans, and
 - g. Ornamental nursery stock and sod farms provided no irrigation with recycled water occurs for a period of 14 days prior to harvesting, retail sale, or allowing access by the general public.
16. No recycled water used for irrigation, or soil that has been irrigated with recycled water, shall come into contact with edible portions of food crops eaten raw by humans.
 17. The storage, delivery, or use of recycled water shall not individually or collectively, directly or indirectly, result in pollution, or adversely affect water quality, as defined in the CWC.
 18. The delivery or use of recycled water shall be in conformance with the reclamation criteria contained in Title 22, or amendments thereto, for the irrigation of food crops, irrigation of fodder, fiber, and seed crops, landscape irrigation, supply of recreational impoundments and ground water recharge.
 19. Prior to delivering recycled water to any new user, BBARWA shall submit to the Colorado River Basin Water Board a report discussing any new distribution system being constructed by the Discharger to provide service to the new user.
 20. Recycled water shall not be delivered to any new user who has not first received a discharge permit from the Colorado River Basin Water Board and approval from the SWRCB's Division of Drinking Water.
 21. Treated or untreated sludge or similar solid waste materials shall be disposed at locations approved by the Colorado River Basin Water Board's Executive Officer.
 22. Grazing of sheep on the irrigation site is allowed only under the following conditions, unless otherwise approved by the Colorado River Basin Water Board 's Executive Officer:
 - a. Grazing will only be conducted in October or November after the last cutting of hay has been baled;
 - b. Grazing animals will not be allowed into a portion of the site until 10 days after it was last irrigated;
 - c. Temporary fences will be erected to contain the grazing animals in an area of 40 acres or less;
 - d. Only ewes that are about to lamb or ewes with newly born will be grazed;
 - e. No animals will be sold for slaughter within 90 days after grazing.
 - f. No milk produced by sheep that have grazed at the irrigation site shall be used for human consumption.

E. Special Provisions

1. Within **three months** of the adoption of this Board Order, the Discharger shall submit a technical report that is a work plan, for approval by the Colorado River Basin Water

Board's Executive Officer, to conduct a study of the groundwater in the vicinity of the recycled water irrigation use site. The objective of the study shall be to address the impacts that the discharges to unlined ponds and the irrigation area have on areal groundwater quality. The Discharger shall submit the final technical report containing the results of the study within **18 months** of the adoption of this Board Order and shall propose recommendations to mitigate the effects of nitrogen loading to groundwater and propose an appropriate effluent limit for TDS.

2. Within six months of the adoption of this Board Order, the Discharger shall prepare and submit an Irrigation Management Plan that includes a water balance and nutrient balance to assure that recycled water is applied at appropriate rates. The Irrigation Management Plan shall be submitted for approval by the Colorado River Basin Water Board's Executive Officer.
3. Within **nine months** of the adoption of this Order, the Discharger shall submit to the Colorado River Basin Water Board office a technical report that includes a copy of the Maintenance and Operations Manual for the Lucerne Valley Facility.

F. Standard Provisions

1. The Discharger shall comply with all of the conditions of this Board Order. Noncompliance is a violation of the Porter-Cologne Water Quality Control Act (CWC, section 13000 et seq.), and is grounds for enforcement action.
2. The Discharger shall comply with Monitoring and Reporting Program R7-2016-0026 and future revisions thereto as specified by the Colorado River Basin Water Board's Executive Officer.
3. The Discharger shall comply with the Electronic Submittal of Information (ESI) requirements by submitting all correspondence and reports required under Monitoring and Reporting Program (MRP) R7-2016-0026, and future revisions thereto, including groundwater monitoring data and discharge location data (latitude and longitude), correspondence, and pdf monitoring reports to the State Water Resources Control Board GeoTracker <https://geotracker.waterboards.ca.gov/> database. Documents that are normally mailed by the Discharger, such as regulatory documents, narrative technical monitoring program reports, and such reports submissions, materials, data, and correspondence, to the Colorado River Basin Water Board shall also be uploaded into GeoTracker in the appropriate Microsoft software application, such as word, excel, or an Adobe Portable Document Format (PDF) file. Large documents are to be split into manageable file sizes appropriately labelled and uploaded into GeoTracker.
4. All technical reports required in conjunction with this Order are required pursuant to Section 13267 of the CWC, and shall include a statement by the Discharger, or an authorized representative of the Discharger, certifying under penalty of perjury under the laws of the State of California, that the report is true, complete, and accurate.
5. In accordance with California Business and Professions Code Sections 6735, 7835, and 7835.1, engineering and geologic evaluations and judgments shall be performed by or under the direction of California registered professionals (i.e., civil engineer, engineering geologist, geologist, etc.) competent and proficient in the fields pertinent to the required activities. All technical reports specified herein that contain work plans, that describe the conduct of investigations and studies, or that contain technical conclusions and

recommendations concerning engineering and geology shall be prepared by or under the direction of appropriately qualified professionals, even if not explicitly stated. Each technical report submitted by the Discharger shall contain a statement of qualifications of the responsible licensed professionals as well as the professional's signature and/or stamp of the seal. Additionally, to the extent that preparation of a required technical report involves field activities, field activities shall be conducted under the direct supervision of one or more of these professionals.

6. The Discharger shall not cause degradation of any water supply in accordance with State Water Board Resolution 68-16.
7. Standby power generating facilities shall be available to operate the plant during a commercial power failure.
8. Adequate measures shall be taken to assure that flood or surface drainage waters do not erode or otherwise render portions of the discharge facilities inoperable.
9. The use of recycled water at the Lucerne Valley Facility shall be supervised by persons possessing certification of appropriate grade pursuant to section 3680, Chapter 26, Division 3, Title 23 of the California Code of Regulations.
10. The Discharger shall at all times properly operate and maintain all systems and components of collection, treatment and control, installed or used by the Discharger to achieve compliance with this Board Order. Proper operation and maintenance includes effective performance, adequate process controls, and appropriate quality assurance procedures. This provision requires the operation of backup or auxiliary facilities/systems when necessary to achieve compliance with this Board Order. All systems in service or reserved shall be inspected and maintained on a regular basis. Records of inspections and maintenance shall be retained, and made available to the Colorado River Basin Water Board's Executive Officer on request.
11. The Discharger shall ensure that all site-operating personnel are familiar with the content of this Board Order, and shall maintain a copy of this Board Order at the site.
12. The Discharger shall allow the Colorado River Basin Water Board, or an authorized representative, upon presentation of credentials and other documents as may be required by law, to:
 - a. Enter the premises regulated by this Board Order, or the place where records are kept under the conditions of this Board Order;
 - b. Have access to and copy, at reasonable times, records kept under the conditions of this Board Order;
 - c. Inspect at reasonable times any facilities, equipment (including monitoring and control equipment), practices, or operations regulated or required under this Board Order; and
 - d. Sample or monitor at reasonable times, for the purpose of assuring compliance with this Board Order or as otherwise authorized by the California Water Code, any substances or parameters at this location.
13. Ponds shall be managed to prevent breeding of mosquitoes. In particular,
 - a. An erosion control program should assure that small coves and irregularities are not

- created around the perimeter of the water surface.
- b. Weeds shall be minimized through control of water depth, harvesting, or herbicides.
 - c. Dead algae, vegetation, and debris shall not accumulate on the water surface.
14. Disposal of oil and grease, biosolids, screenings, and other solids collected from liquid wastes shall be pursuant to Title 27, and the review and approval of the Colorado River Basin Water Board Executive Officer.
 15. Any proposed change in use or disposal of biosolids requires the approval of the Colorado River Basin Water Board Executive Officer, and U.S. Environmental Protection Agency Regional Administrator, who must be notified at least 90 days in advance of the change.
 16. Sludge use and disposal shall comply with Federal and State laws and regulations, including permitting requirements, and technical standards in 40 CFR Part 503. If the State and Colorado River Basin Water Boards are delegated the authority to implement 40 CFR Part 503 regulations, this Order may be revised to incorporate appropriate time schedules and technical standards. The Discharger shall comply with the standards and time schedules in 40 CFR part 503, whether or not part of this Order.
 17. The Discharger shall provide a plan as to the method, treatment, handling and disposal of sludge that is consistent with all State and Federal laws and regulations and obtain prior written approval from the Colorado River Basin Water Board specifying location and method of disposal, before disposing of treated or untreated sludge, or similar solid waste.
 18. The Discharger shall maintain a permanent log of all solids hauled away from the treatment facility for use/disposal elsewhere and shall provide a summary of the volume, type (screenings, grit, raw sludge, digested sludge), use (agricultural, composting, etc.), and the destination in accordance with the MRP of this Board Order. Sludge that is stockpiled at the treatment facility shall be sampled and analyzed for those constituents listed in the sludge monitoring section of the MRP of this Board Order and as required by Title 40, Code of Federal Regulations, Part 503. The results of the analyses shall be submitted to the Colorado River Basin Water Board as part of the MRP.
 19. The Discharger shall provide a report to the Colorado River Basin Water Board when it determines that the plant's average dry-weather flow rate for any month exceeds 80 percent of the design capacity. The report should indicate what steps, if any, the Discharger intends to take to provide for the expected wastewater treatment capacity necessary when the plant reaches design capacity.
 20. Prior to implementing a modification that results in a material change in the quality or quantity of wastewater treated or discharged, or a material change in the location of discharge, the Discharger shall report all pertinent information in writing to the Colorado River Basin Water Board, and obtain revised requirements.
 21. Prior to a change in ownership or management of the Lucerne Valley Facility, the Discharger shall transmit a copy of this Board Order to the succeeding owner/operator, and forward a copy of the transmittal letter to the Colorado River Basin Water Board.
 22. The Discharger shall provide adequate notice to the Colorado River Basin Water Board

Executive Officer of the following:

- a. Any substantial change in the volume or character of pollutants introduced into any treatment facility described in the Findings of this Board Order, by an existing or new source; and
 - b. Any planned physical alteration or addition to the facilities described in this Board Order, or change planned in the Discharger's sludge use or disposal practice, where such alterations, additions, or changes may justify the application of Board Order conditions that are different from or absent in the existing Board Order, including notification of additional disposal sites not reported during the Board Order application process, or not reported pursuant to an approved land application plan.
23. The Discharger shall report orally, any noncompliance that may endanger human health or the environment. The noncompliance shall be reported immediately to the Colorado River Basin Water Board's Executive Officer at (760) 346-7491, and the California Office of Emergency Services at (800) 852-7550 as soon as:
- a. The Discharger has knowledge of the discharge,
 - b. Notification is possible, and
 - c. Notification will not substantially impede cleanup or other emergency measures.

During non-business hours, the Discharger shall leave a message on the Colorado River Basin Water Board's office voice recorder at the above listed number. Incident information shall be provided orally as soon as possible and within 24 hours from the time the Discharger becomes aware of the incident. A written report shall also be provided within five (5) business days of the time the Discharger becomes aware of the incident. The written report shall contain a description of the noncompliance and its cause, the period of noncompliance, the anticipated time to achieve full compliance, and the steps taken or planned, to reduce, eliminate, and prevent recurrence of the noncompliance. The Discharger shall report all intentional or unintentional spills in excess of one thousand (1,000) gallons occurring within the Colorado River Basin Water Board's jurisdiction, including the Lucerne Valley Facility or disposal line, in accordance with the above time limits.

24. The Discharger shall report all instances of noncompliance. Reports of noncompliance shall be submitted with the Discharger's next scheduled SMRs or earlier if requested by the Colorado River Basin Water Board's Executive Officer, or if required by an applicable standard for sludge use and disposal.
25. By-pass (i.e., the intentional diversion of waste streams from any portion of the treatment facilities, except diversions designed to meet variable effluent limits) is prohibited. The Colorado River Basin Water Board may take enforcement action against the Discharger for by-pass unless:
- a. By-pass was unavoidable to prevent loss of life, personal injury, or severe property damage. Severe property damage means substantial physical damage to property, damage to the treatment facilities that causes them to be inoperable, or substantial and permanent loss of natural resources reasonably expected to occur in the absence of a by-pass. Severe property damage does not mean economic loss caused by delays in production; and

There were no feasible alternatives to by-pass, such as the use of auxiliary treatment

- facilities or retention of untreated waste. This condition is not satisfied if adequate back-up equipment was not installed to prevent by-pass occurring during equipment downtime, or preventive maintenance.
- b. By-pass is:
- i. Required for essential maintenance to assure efficient operation; and
 - ii. Neither effluent nor receiving water limitations are exceeded; and
 - iii. The Discharger notifies the Colorado River Basin Water Board ten (10) days in advance.
26. In the event of an unanticipated by-pass, the Discharger shall immediately report the incident to the Colorado River Basin Water Board. During non-business hours, the Discharger shall leave a message on the Colorado River Basin Water Board office voice recorder. A written report shall be provided within five business days the Discharger is aware of the incident. The written report shall include a description of the by-pass, any noncompliance, the cause, period of noncompliance, anticipated time to achieve full compliance, and steps taken or planned, to reduce, eliminate, and prevent recurrence of the noncompliance.
27. Federal regulations for storm water discharges require specific categories of facilities which discharge storm water associated with industrial activity (storm water) to obtain National Pollutant Discharge Elimination System (NPDES) permits and to implement Best Conventional Pollutant Technology (BCT) and Best Available Technology Economically Achievable (BAT) to reduce or eliminate industrial storm water pollution.
28. All storm water discharges from this facility must comply with the lawful requirements of municipalities, counties, drainage districts, and other local agencies, regarding discharges of storm water to storm water drain systems or other courses under their jurisdiction.
29. Storm water discharges from the facility shall not cause or threaten to cause pollution or contamination.
30. Storm water discharges from the facility shall not contain hazardous substances equal to or in excess of a reportable quantity listed in 40 CFR Part 117 and/or 40 CFR Part 302.
31. The Discharger is the responsible party for the waste discharge requirements and the monitoring and reporting program for the facility. The Discharger shall comply with all conditions of these waste discharge requirements. Violations may result in enforcement actions, including Colorado River Basin Water Board Orders or court orders, requiring corrective action or imposing civil monetary liability, or in modification or revocation of these waste discharge requirements by the Colorado River Basin Water Board.
32. This Board Order does not authorize violation of any federal, state, or local laws or regulations.
33. This Board Order does not convey property rights of any sort, or exclusive privileges, nor does it authorize injury to private property or invasion of personal rights, or infringement of federal, state, or local laws or regulations.
34. This Board Order may be modified, rescinded, or reissued, for cause. The filing of a

request by the Discharger for a Board Order modification, rescission or reissuance, or notification of planned changes or anticipated noncompliance, does not stay any Board Order condition. Causes for modification include a change in land application plans, or sludge use or disposal practices, and adoption of new regulations by the State or Colorado River Basin Water Board (including revisions to the Basin Plan), or Federal government.

I, Jose L. Angel, Executive Officer, do hereby certify the foregoing is a full, true and correct copy of an Order adopted by the California Regional Water Quality Control Board, Colorado River Basin Region, on June 30, 2016.



JOSE L. ANGEL P.E.
Executive Officer

CALIFORNIA REGIONAL WATER QUALITY CONTROL BOARD
COLORADO RIVER BASIN REGION

MONITORING AND REPORTING PROGRAM R7-2016-0026
FOR
BIG BEAR AREA REGIONAL WASTEWATER AGENCY, OWNER/OPERATOR
EXPORT OF RECYCLED WATER TO LUCERNE VALLEY
Lucerne Valley – San Bernardino County

Location of Discharge:
Section 14, T4N, R1E, SBB&M

A. Monitoring

1. This Monitoring and Reporting Program (MRP) describes requirements for monitoring a wastewater system and groundwater quality (when needed). This MRP is issued pursuant to California Water Code (CWC) section 13267. The Discharger shall not implement any changes to this MRP unless and until a revised MRP is issued by the Executive Officer.
2. Water Code section 13267 states, in part:

“In conducting an investigation specified in subdivision (a), the Colorado River Basin Water Board may require that any person who has discharged, discharges, or is suspected of having discharged or discharging, or who proposes to discharge waste within its region, or any citizen or domiciliary, or political agency or entity of this state who has discharged, discharges, or is suspected of having discharged or discharging, or who proposes to discharge, waste outside of its region that could affect the quality of waters within its region shall furnish, under penalty of perjury, technical or monitoring program reports which the Colorado River Basin Water Board requires. The burden, including costs, of these reports shall bear a reasonable relationship to the need for the report and the benefits to be obtained from the reports. In requiring those reports, the Colorado River Basin Water Board shall provide the person with a written explanation with regard to the need for the reports, and shall identify the evidence that supports requiring that person to provide the reports.”
3. Water Code section 13268 states, in part:

“(a) (1) Any person failing or refusing to furnish technical or monitoring program reports as required by subdivision (b) of section 13267, or failing or refusing to furnish a statement of compliance as required by subdivision (b) of section 13399.2, or falsifying any information provided therein, is guilty of a misdemeanor, and may be liable civilly in accordance with subdivision (b). (b) (1) Civil liability may be administratively imposed by a Colorado River Basin Water Board in accordance with Article 2.5 (commencing with section 13323) of Chapter 5 for a violation of subdivision (a) in an amount which shall not exceed one thousand dollars (\$1,000) for each day in which the violation occurs.”
4. BBARWA owns and operates the wastewater system that is subject to Board Order R7-2016-0026. The reports are necessary to ensure that the Discharger complies with the Order. Pursuant to Water Code section 13267, the Discharger shall implement the MRP and shall submit the monitoring reports described herein.
5. All samples shall be representative of the volume and nature of the discharge or matrix of material sampled. The time, date, and location of each grab sample shall be recorded

on the sample chain of custody form. If composite samples are collected, the basis for sampling (time or flow weighted) shall be approved by Colorado River Basin Water Board staff.

6. Field test instruments (such as those used to test pH, dissolved oxygen, and electrical conductivity) may be used provided that:
 - a. The user is trained in proper use and maintenance of the instruments;
 - b. The instruments are field calibrated prior to monitoring events at the frequency recommended by the manufacturer;
 - c. Instruments are serviced and/or calibrated by the manufacturer at the recommended frequency; and
 - d. Field calibration reports are submitted as described in the "Reporting" section of this MRP.
7. The collection, preservation and holding times of all samples shall be in accordance with U. S. Environmental Protection Agency (USEPA) approved procedures. Unless otherwise approved by the Colorado River Basin Water Board's Executive Officer, all analyses shall be conducted by a laboratory certified by the State Water Resources Control Board, Division of Drinking Water. All analyses shall be conducted in accordance with the latest edition of the "Guidelines Establishing Test Procedures for Analysis of Pollutants" (40 CFR Part 136), promulgated by the USEPA.
8. All monitoring instruments and devices used by the Discharger to fulfill the prescribed monitoring program shall be properly maintained and calibrated as necessary to ensure their continued accuracy. In the event that continuous monitoring equipment is out of service for period greater than 24-hours, the Discharger shall obtain representative grab samples each day the equipment is out of service. The Discharger shall correct the cause(s) of failure of the continuous monitoring equipment as soon as practicable. The Discharger shall report the period(s) during which the equipment was out of service and if the problem has not been corrected, shall identify the steps which the Discharger is taking or proposes to take to bring the equipment back into service and the schedule for these actions.
9. The Discharger shall retain records of all monitoring information, including all calibration and maintenance records and all original strip chart recordings for continuous monitoring instrumentation, copies of all reports required by this Board Order, and records of all data used to complete the application for this Board Order, for a period of at least five (5) years from the date of the sample, measurement, report or application. This period may be extended by request of the Colorado River Basin Water Board's Executive Officer at any time. Records of monitoring information shall include:
 - a. The date, exact place, and time of sampling or measurement(s);
 - b. The individual(s) who performed the sampling or measurement(s);
 - c. The date(s) analyses were performed;
 - d. The individual(s) who performed the analyses;
 - e. The analytical techniques or method used; and
 - f. The results of such analyses.
10. Samples shall be collected at the location specified in the WDRs. If no location is

specified, sampling shall be conducted at the most representative sampling point available.

11. Given the monitoring frequency prescribed by MRP R7-2016-0026, if only one sample is available for a given reporting period, compliance with monthly average, or weekly average Discharge Specifications, will be determined from that sample.
12. If the facility is not in operation, or there is no discharge during a required reporting period, the Discharger shall forward a letter to the Colorado River Basin Water Board indicating that there has been no activity during the required reporting period.

Effluent Monitoring

13. Representative samples of the undisinfected secondary recycled water shall be taken at the WWTP. The samples shall be analyzed for the following constituents:

<u>Constituent</u>	<u>Units</u>	<u>Type of Sample</u>	<u>Monitoring Frequency</u>	<u>Reporting Frequency</u>
Irrigation Flow	MGD	Flow Meter Reading	Daily	Monthly
20°C BOD ₅	mg/L	24 Hr. Composite	2x/Month	Monthly
Total Suspended Solids	mg/L	24 Hr. Composite	2x/Month	Monthly
pH	s.u. ¹	Grab	Daily	Monthly
Dissolved Oxygen ²	mg/L	Grab	Monthly	Monthly
Total Dissolved Solids	mg/L	24 Hr. Composite	Monthly	Monthly
Sulfate (SO ₄)	mg/L	24 Hr. Composite	Monthly	Monthly
Chloride	mg/L	24 Hr. Composite	2x/Month	Monthly
Fluoride (F)	mg/L	24 Hr. Composite	Monthly	Monthly
Nitrate (NO ₃ -N) as N	mg/L	24 Hr. Composite	Monthly	Monthly
Total Nitrogen	mg/L	24 Hr. Composite	Monthly	Monthly
VOCs ³	µg/L ⁴	24 Hr. Composite	Annually	Annually

Overflow Pond Monitoring

14. During months when the overflow evaporation/percolation ponds are not used, the Discharger shall report that there has been no activity. During months when the overflow evaporation percolation ponds are in use, the ponds shall be monitored according to the following schedule:

¹ standard pH units

² Dissolved Oxygen shall be monitored at the upper one foot layer of the storage or percolation ponds.

³ Analysis of Volatile Organic Compounds is to be accomplished using the USEPA test methods 601, 602 or 624

⁴ micrograms per liter

<u>Constituent</u>	<u>Units</u>	<u>Type of Sample</u>	<u>Monitoring Frequency</u>	<u>Reporting Frequency</u>
Flow Quantity	MGD	Flow Measurement	Daily	Monthly
Dissolved Oxygen	mg/L	Grab	Twice Monthly	Monthly
pH	s.u.	Grab	Twice Monthly	Monthly
Total Dissolved Solids	mg/L	Grab	Twice Monthly	Monthly
Freeboard	ft	Measurement	Twice Monthly	Monthly

Groundwater Monitoring

15. The groundwater monitoring wells shall be monitored according to the following schedule:

<u>Constituent</u>	<u>Units</u>	<u>Type of Sample</u>	<u>Monitoring⁵ Frequency</u>	<u>Reporting Frequency</u>
Depth to Groundwater	ft (msl) ⁶	Measurement	Monthly	Monthly
Groundwater Gradient ⁷	NA	Direction	Monthly	Monthly
Total Nitrogen	mg/L	Grab	Monthly	Monthly
Nitrate as N	mg/L	Grab	Monthly	Monthly
Chloride	mg/L	Grab	Monthly	Monthly
Fluoride	mg/L	Grab	Monthly	Monthly
Sulfate	mg/L	Grab	Monthly	Monthly
Total Dissolved Solids	mg/L	Grab	Monthly	Monthly
Boron	mg/L	Grab	Monthly	Monthly
VOCs	µg/L	Grab	Annually	Annually

Domestic Water Supply Monitoring

16. The domestic water supply shall be a flow weighted composite sample monitored at the water supply production wells in Big Bear Valley and include notations of which wells are non-operating for a reporting period and in accordance to the following schedule:

<u>Constituent</u>	<u>Units</u>	<u>Type of Sample</u>	<u>Monitoring Frequency</u>	<u>Reporting Frequency</u>
Total Dissolved Solids	mg/L	Grab	Annually	Annually

⁵ Groundwater monitoring shall be performed monthly for the first 12 months and quarterly thereafter.

⁶ Above mean sea level.

⁷ Groundwater flow direction.

B. Reporting

1. The Discharger shall inspect and document any operation/maintenance problems by inspecting each unit process. Operation and Maintenance reports shall be submitted to the Colorado River Basin Water Board Office annually, containing documentation showing the calibration of flow meters and equipment as performed in a timely manner, modifications and updates to the Operation and Maintenance Manual, and modifications and updates to the Agency's waste water ordinance or rules and regulations.
2. The Discharger shall annually report a trend monitoring analysis for total nitrogen and nitrates in the groundwater in the vicinity of the recycled water use site. The analysis shall be reported with the Discharger's annual Self-Monitoring Report (SMR).
3. The Discharger shall provide an annual nitrogen balance for the recycled water use site which includes nitrogen loading by application of recycled water and the use of fertilizers for farming. Nitrogen balance shall consider nitrogen uptake by crops grown and provide documentation of crop-specific nitrogen uptake rates. The analysis shall be reported with the Discharger's annual SMR.
4. The Discharger shall provide an operator certification status update including number of staff and grade certification annually.
5. SMRs shall be certified under penalty of perjury to be true and correct, and shall contain the required information at the frequency designated in this MRP.
6. Each Report must contain an affirmation in writing that:

"All analyses were conducted at a laboratory certified for such analyses by and in accordance with current USEPA procedures or as specified in this Monitoring and Reporting Program."

7. Each Report shall contain the following completed declaration:

"I certify under the penalty of law that this document, including all attachments and supplemental information, was prepared under my direction or supervision in accordance with a system designed to assure that qualified personnel properly gathered and evaluated the information submitted. I have personally examined and am familiar with the information submitted in this document, and that based on my inquiry of those individuals immediately responsible for obtaining the information, I believe that the information is true, accurate, and complete. I am aware that there are significant penalties for submitting false information, including the possibility of a fine and imprisonment.

Executed on the _____ day of _____ at _____

(Signature)

(Title)"

8. The SMRs, and other information requested by the Colorado River Basin Water Board, shall be signed by a principal executive officer or ranking elected official.
9. A duly authorized representative of the Discharger may sign the documents if:
 - a. The authorization is made in writing by the person described above;

- b. The authorization specified an individual or person having responsibility for the overall operation of the regulated disposal system; and
 - c. The written authorization is submitted to the Colorado River Basin Water Board's Executive Officer.
10. The Discharger shall attach a cover letter to the SMRs. The information contained in the cover letter shall clearly identify violations of the WDRs; discuss corrective actions taken or planned and the proposed time schedule of corrective actions. Identified violations should include a description of the requirement that was violated and a description of the violation.
11. Daily, weekly, and monthly monitoring shall be included in the monthly monitoring report. Monthly monitoring reports shall be submitted to the Colorado River Basin Water Board by the 15th day of the following month. Quarterly monitoring reports shall be submitted by January 15th, April 15th, July 15th and October 15th. Annual monitoring reports shall be submitted by January 31st of the following year.
12. The Discharger shall comply with the Electronic Submittal of Information (ESI) requirements by submitting all correspondence and reports required under Monitoring and Reporting Program (MRP) R7-2016-0026, and future revisions thereto, including groundwater monitoring data and discharge location data (latitude and longitude), correspondence, and pdf monitoring reports to the State Water Resources Control Board GeoTracker database. Documents that are 2.0 MB or larger should be broken down into smaller electronic files, labelled properly and uploaded into GeoTracker.



JOSE L. ANGEL P.E.
Executive Officer



Date

CALIFORNIA REGIONAL WATER QUALITY CONTROL BOARD
COLORADO RIVER BASIN REGION

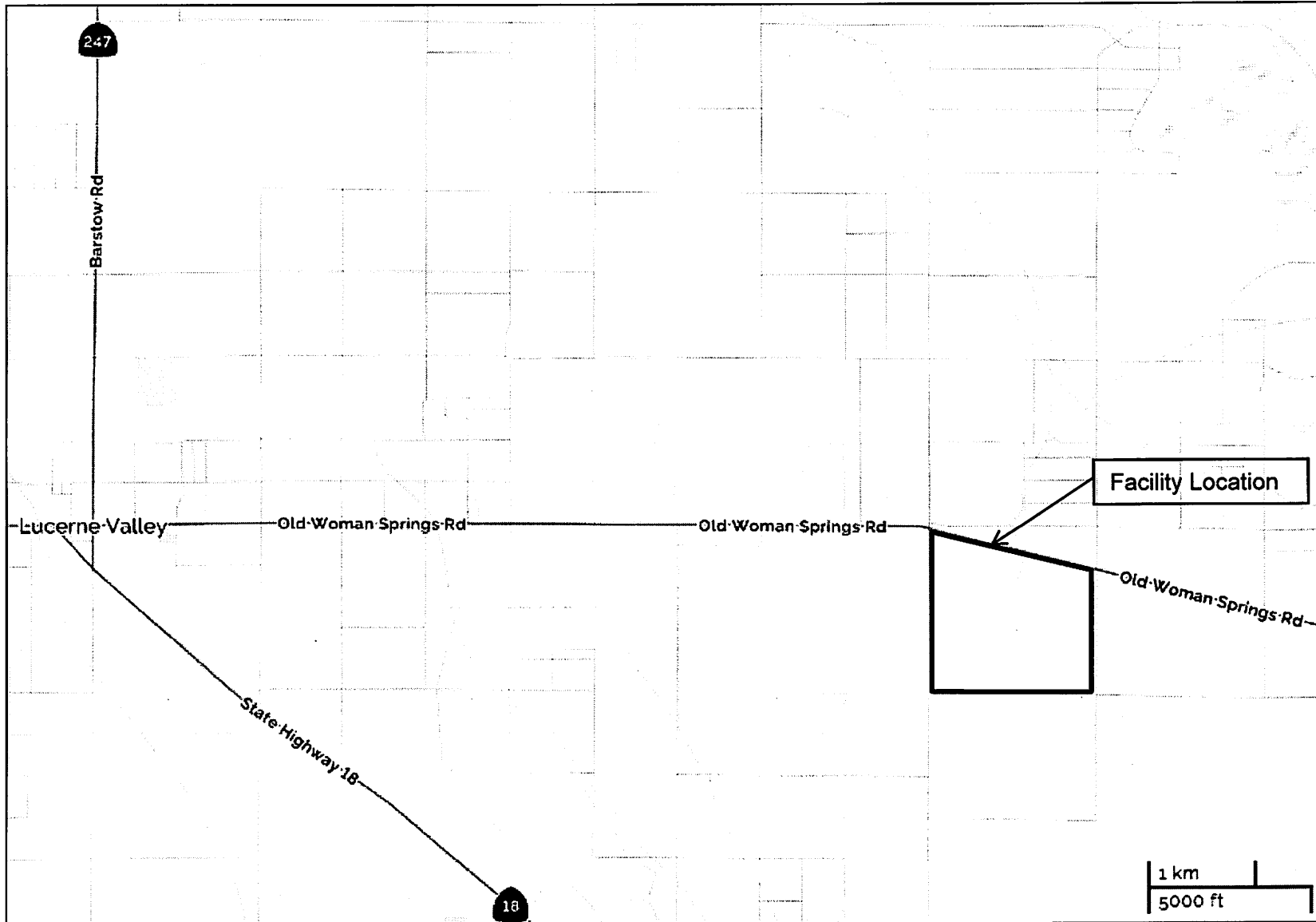

BIG BEAR AREA REGIONAL WASTEWATER AGENCY, OWNER/OPERATOR
EXPORT OF RECYCLED WATER TO LUCERNE VALLEY
Lucerne Valley – San Bernardino County
Section 14, T4N, R1E, SBB&M

**CALIFORNIA REGIONAL WATER QUALITY CONTROL BOARD
COLORADO RIVER BASIN REGION**

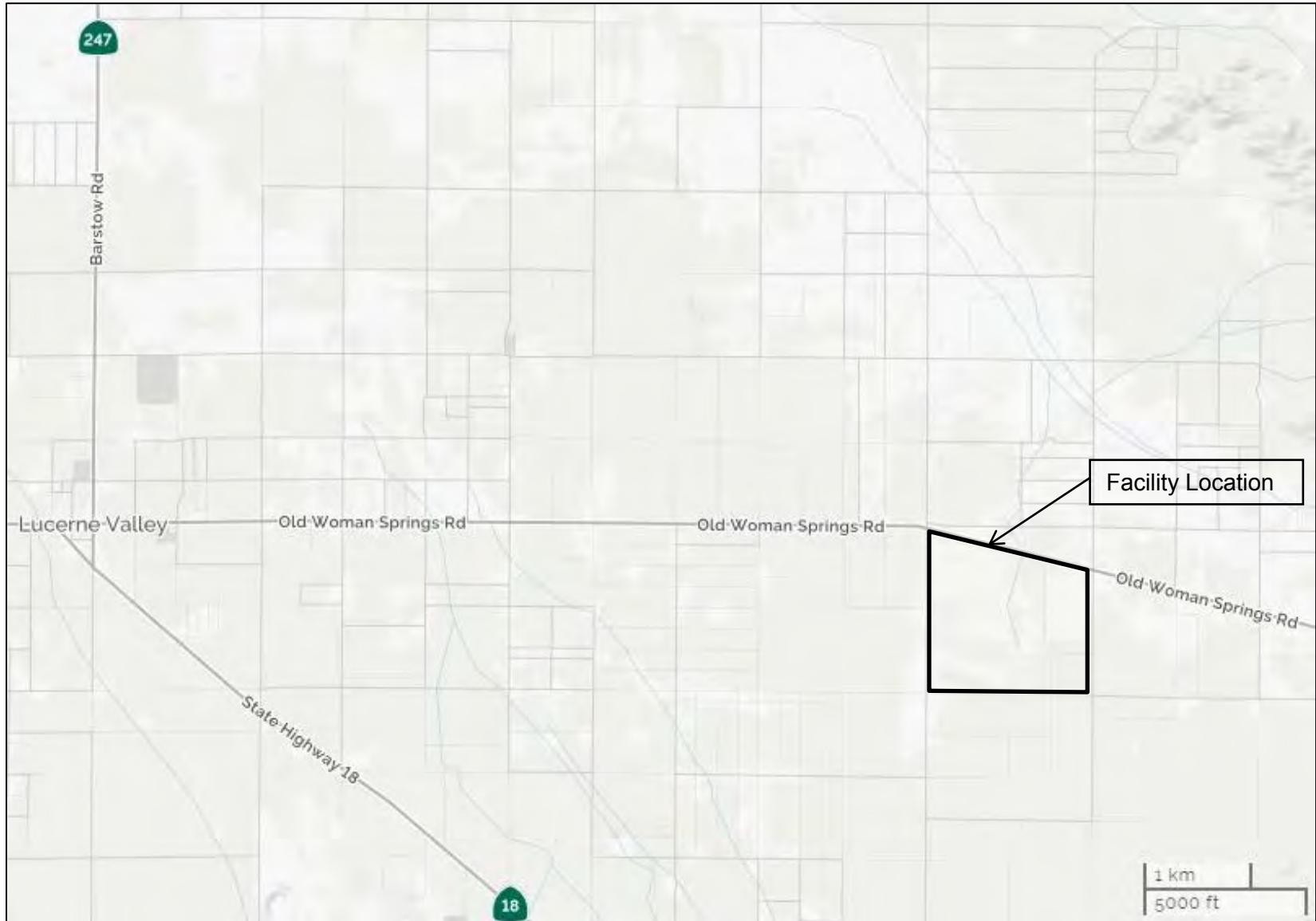

**BIG BEAR AREA REGIONAL WASTEWATER AGENCY, OWNER/OPERATOR
EXPORT OF RECYCLED WATER TO LUCERNE VALLEY
Lucerne Valley – San Bernardino County
Section 14, T4N, R1E, SBB&M**

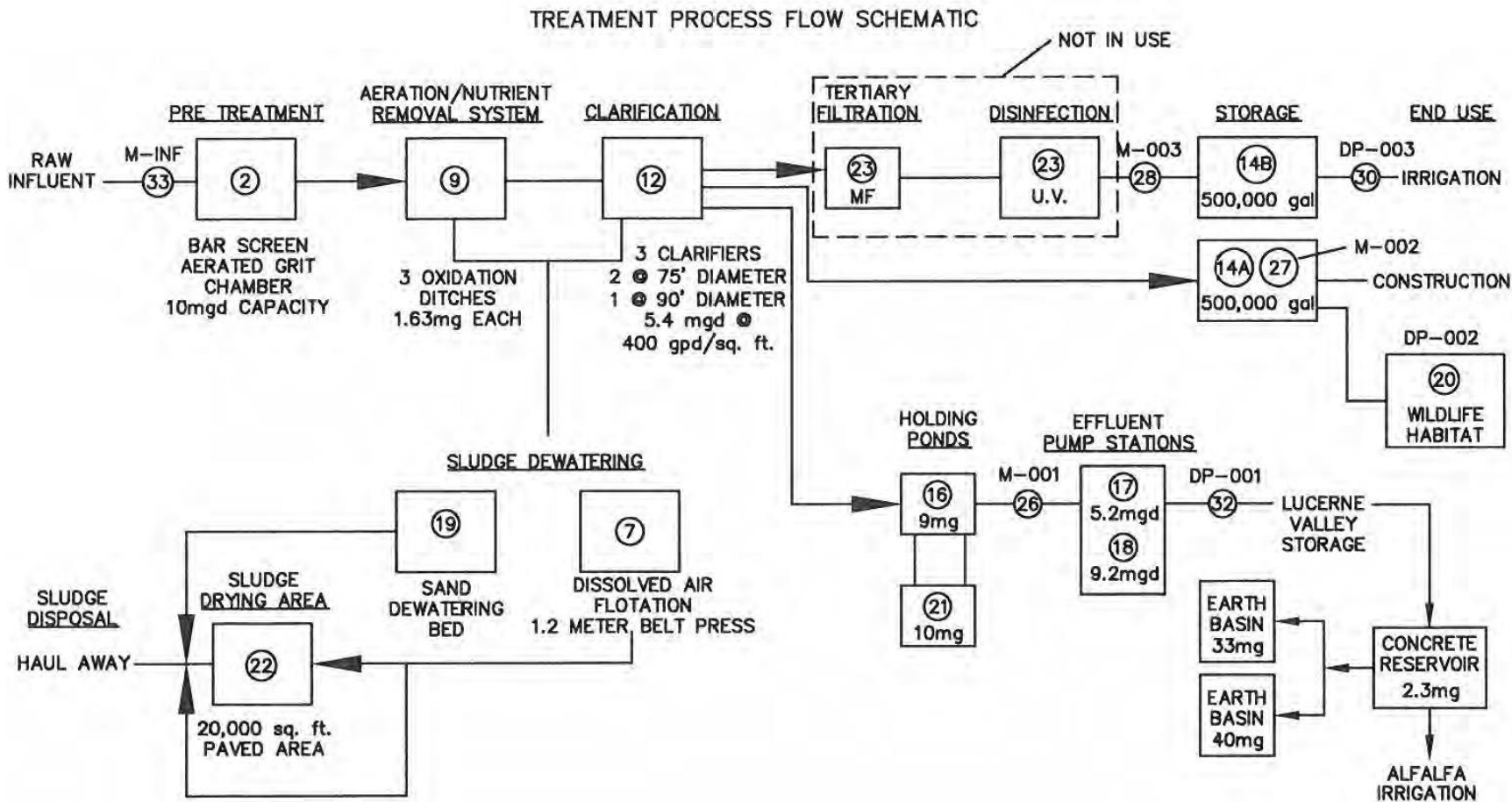



BIG BEAR AREA REGIONAL WASTEWATER AGENCY, OWNER/OPERATOR
EXPORT OF RECYCLED WATER TO LUCERNE VALLEY
Lucerne Valley – San Bernardino County



California Regional Water Quality Control Board

Santa Ana Region

3737 Main Street, Suite 500, Riverside, California 92501-3348
Phone (951) 782-4130 - FAX (951) 781-6288
<http://www.waterboards.ca.gov/santaana>



Alan C. Lloyd, Ph.D.
Agency Secretary

Arnold Schwarzenegger
Governor

ORDER NO. R8-2005-0044

WASTE DISCHARGE AND PRODUCER/USER WATER RECYCLING REQUIREMENTS

The following Discharger is authorized to discharge in accordance with the Waste Discharge Requirements set forth in this Order:

Discharger	Big Bear Area Regional Wastewater Agency
Name of Facility	Regional Treatment Plant, Big Bear City
Facility Address	122 Palomino Drive
	Big Bear City, CA 92314
	San Bernardino

The Discharger is authorized to discharge from the following discharge points as set forth below:

Discharge Point	Effluent Description	Discharge Point Latitude	Discharge Point Longitude	Receiving Water	Disposal Site	Recycling Reuse
001	Secondary effluent without disinfection	34 ° 26' 20" N	116 ° 51' 20" W	Lucerne Hydrologic Unit	Storage Ponds in Lucerne Valley	Irrigation in Lucerne Valley ¹
002	Secondary effluent with disinfection	34 ° 16' 10" N	116 ° 49' 00" W	State surface water: Storage pond in Baldwin Lake; Big Bear Valley groundwater management zone	--	construction and wildlife habitat
003	Tertiary effluent with disinfection	34 ° 16' 10" N	116 ° 49' 00" W	Big Bear Valley groundwater management zone	--	Irrigation

This Order was adopted by the Regional Water Board on:	June 24, 2005
This Order shall become effective on:	June 24, 2005

¹ The Colorado River Basin Regional Water Quality Control Board (Region 7) has issued waste discharge requirements for the use of the recycled wastewater in the Lucerne Valley.

IT IS HEREBY ORDERED, that Order No. 00-12 is superseded upon the effective date of this Order except for enforcement purposes, and, in order to meet the provisions contained in Division 7 of the California Water Code (CWC) and regulations adopted thereunder, the Discharger shall comply with the requirements in this Order.

I, Gerard J. Thibeault, Executive Officer, do hereby certify that Order No. R8- 2005-0044 with all attachments is a full, true, and correct copy of an Order adopted by the California Regional Water Quality Control Board, Santa Ana Region, on June 24, 2005.

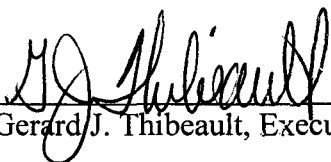

Gerard J. Thibeault, Executive Officer

**CALIFORNIA REGIONAL WATER QUALITY CONTROL BOARD
REGION 8, SANTA ANA REGION**

ORDER NO. R8-2005-0044

TABLE OF CONTENTS

I.	Facility Information	4
II.	Findings.....	4
III.	Discharge Prohibitions.....	7
IV.	Effluent Limitations and Discharge Specifications	8
	A. Effluent limitations – Discharge Points – 001, 002, and 003, beginning June 24, 2005:	8
	B. Reclamation Specifications- Discharge Points 001, 002, and 003.....	10
V.	Receiving Water Limitations	11
	A. Groundwater Limitations	11
VI.	Provisions.....	12
	A. General Provisions:	12
	B. Monitoring and Reporting Program Requirements	13
	C. Special Provisions	13
VII.	Compliance Determination	14
	A. Average Monthly Effluent Limitation (AMEL).....	14
	B. Average Weekly Effluent Limitation (AWEL).....	15
	C. Maximum Daily Effluent Limitation (MDEL).	15
	D. Compliance with the 12-month average limit under Effluent Limitations.	15
	E. Time Interval.	15
	F. For Non-Priority Pollutants.	15
	Attachment A – Definitions	A-1
	Attachment B – Topographic Map	B-1
	Attachment C – Flow Schematic	C-1
	Attachment D – Monitoring and Reporting Program (MRP)	D-1
	Attachment E – Fact Sheet.....	E-1

I. FACILITY INFORMATION

The following Discharger is authorized to discharge in accordance with the Waste Discharge Requirements set forth in this Order:

Discharger	Big Bear Area Regional Wastewater Agency
Name of Facility	Regional Treatment Plant, Big Bear City
Facility Address	122 Palomino Drive
	Big Bear City, CA 92314
	San Bernardino
Facility Contact, Title, and Phone	Joseph Hanford, Interim Plant Superintendent (909) 584-4018
Mailing Address	P. O. BOX 517, 122 Palomino Drive, Big Bear City, CA 92314
Type of Facility	POTW
Facility Design Flow	4.89 million gallons per day (mgd)

II. FINDINGS

The California Regional Water Quality Control Board, Santa Ana Region (hereinafter Regional Water Board), finds:

- A. **Background.** Big Bear Area Regional Wastewater Agency (hereinafter Discharger) is currently discharging pursuant to Order No. 00-12 and National Pollutant Discharge Elimination System (NPDES) Permit No. CA8000344. The Discharger submitted a Report of Waste Discharge, dated August 26, 2004, and applied for renewal of waste discharge requirements to discharge up to 4.89 mgd of secondary treated and/or up to 1.0 mgd of tertiary treated wastewater from the Regional Treatment Plant, hereinafter Facility. The application was deemed complete on February 14, 2005.

The discharger has eliminated two previous discharge locations into the waters of the U.S. These two discharge locations were Discharge Serial No. 002 (East end of Stanfield Marsh) and 003 (Baldwin Lake Stickleback habitat). The discharger plans to deliver recycled water to a pond in Baldwin Lake to create a wildlife habitat area. Based on the U.S. Army Corps of Engineers' determination, the pond within the Baldwin Lake area is not considered waters of the U.S. Therefore, this Order is issued as Waste Discharge and Producer/User Water Recycling Requirements; an NPDES permit is no longer necessary.

- B. Facility Description.** The Discharger owns and operates a POTW. The treatment system consists of: preliminary treatment, secondary treatment, tertiary treatment, disinfection system, and sludge treatment system. Most of the treated wastewater is discharged through Discharge Point 001 (see table on cover page) into storage ponds in the Lucerne Valley for use in irrigation of fodder, fiber and seed crops. A minimal volume of treated wastewater is discharged through Discharge Points 002 and 003 for recycling and reuse at various sites for irrigation, dust control at construction sites, and wildlife habitat restoration in the Baldwin Lake. Attachment B provides a map of the area around the facility. Attachment C provides a flow schematic of the facility.

Stormwater runoff from the three discharge points of the RTP discharges into a flood zone, which is located at the east side of the plant. In heavy storm seasons, there is the possibility of overflow from the flooding zone into offsite surface waters.

- C. Legal Authorities.** This Order is issued pursuant to Chapter 5.5, Division 7 of the California Water Code (CWC). This Order serves as Waste Discharge Requirements (WDRs) pursuant to Article 4, Chapter 4 of the CWC.

This Order also includes requirements based on Title 22, Division 4, Chapter 3, of California Code of Regulations, which specifies regulations for the use of recycled water for irrigation and construction purposes.

- D. Background and Rationale for Requirements.** The Regional Water Board developed the requirements in this Order based on information submitted as part of the application and through monitoring and reporting programs. Attachments A through F, which contain background information and rationale for Order requirements, are hereby incorporated into this Order and, thus, constitute part of the Findings for this Order.
- E. California Environmental Quality Act (CEQA).** The project involves the update of waste discharge requirements for an existing facility and, as such, is exempt from the California Environmental Quality Act (Public Resources Code, Section 21100 et. seq.) in accordance with Section 15301, Chapter 3, Title 14, California Code of Regulations.
- F. Water Quality Control Plans.** The Regional Water Board adopted a revised Water Quality Control Plan for the Santa Ana Region (hereinafter Basin Plan) that became effective on January 24, 1995. The Basin Plan designates beneficial uses, establishes water quality objectives, and contains implementation programs and policies to achieve those objectives for all waters in the Santa Ana Region addressed through the plan. More recently, the Basin Plan was amended significantly to incorporate revised boundaries for groundwater subbasins, now termed "management zones", new nitrate-nitrogen and TDS objectives for the new management zones, and new nitrogen and TDS management strategies applicable to both surface and ground waters. This Basin Plan Amendment was adopted by the Regional Board on January 22, 2004. The State Water Resources Control Board and Office of Administrative Law (OAL) approved the Amendment on September 30, 2004 and December 23, 2004, respectively.

These Basin Plan changes did not affect groundwater in the Big Bear area, apart from the re-designation of the Big Bear Valley groundwater subbasin as a groundwater management zone. Beneficial uses applicable to the Big Bear Valley Groundwater Management Zone and Lucerne Hydrologic Unit are as follows:

Discharge Point	Receiving Water Name	Beneficial Use(s)
001	Lucerne Hydrologic Unit	Based on Region 7's Basin Plan. 1. Municipal supply 2. Industrial supply 3. Agricultural supply
002	A pond in Baldwin Lake; and Big Bear Valley groundwater management zone	<u>Beneficial Uses for Baldwin Lake:</u> <u>Intermittent:</u> 1. Water contact recreation (REC-1), 2. Non-contact water recreation (REC-2), 3. Warm freshwater habitat (WARM), 4. Cold freshwater habitat (COLD), 5. Preservation of biological habitats of special significance (BIOL), 6. Wildlife habitat (WILD), and 7. Rare, threatened or endangered species (RARE). <u>Beneficial Uses for groundwater management zone:</u> <u>Present or Potential:</u> Municipal and domestic supply, industrial service supply.
003	Big Bear Valley groundwater management zone	<u>Beneficial Uses for ground water management zone:</u> <u>Present or potential:</u> Municipal and domestic supply, industrial service supply.

Requirements of this Order specifically implement the applicable Water Quality Control Plans.

G. Industrial Stormwater Requirements. Pursuant to Section 402(p) of the Clean Water Act and Title 40 of the Code of Federal Regulations (CFR) Part 122, 123, and 124, the State Water Resources Control Board adopted general NPDES permits to regulate storm water discharges associated with industrial activities (State Board Order No. 97-03-DWQ) adopted on April 17, 1997. The discharger's stormwater program was regulated previously under Order No. 00-12. For this Order, storm water discharge from the RTP is subject to requirements under the general permit. The discharger shall submit notice of intent to be covered under this general permit and develop and implement Storm Water Pollution Prevention Plans to comply with the general NPDES permit.

- H. **Antidegradation Policy.** The State Water Board established California's antidegradation policy in State Water Board Resolution No. 68-16. Resolution No. 68-16 requires that existing quality of waters be maintained unless degradation is justified based on specific findings. As discussed in the Fact Sheet (Attachment E), the permitted discharge is consistent with the antidegradation provisions of State Water Board Resolution No. 68-16.
- I. **Monitoring and Reporting.** Sections 13267 and 13383 of the CWC authorize the Regional Water Boards to require technical and monitoring reports. The Monitoring and Reporting Program establishes monitoring and reporting requirements to implement State requirements. This Monitoring and Reporting Program is provided in Attachment D.
- J. **Biosolids Requirements.** On February 19, 1993, the USEPA issued a final rule for the use and disposal of sewage sludge, 40 CFR, Part 503. This rule requires that producers of sewage sludge meet certain reporting, handling, and disposal requirements. The State of California has not been delegated the authority to implement this program, therefore, the U.S. Environmental Protection Agency is the implementing agency. However, this Order includes Regional Board biosolids requirements.
- K. **Notification of Interested Parties.** The Regional Water Board has notified the Discharger and interested agencies and persons of its intent to prescribe Waste Discharge Requirements for the discharge and has provided them with an opportunity to submit their written comments and recommendations. Details of notification are provided in the Fact Sheet (Attachment E) of this Order.
- L. **Consideration of Public Comment.** The Regional Water Board, in a public meeting, heard and considered all comments pertaining to the discharge. Details of the Public Hearing are provided in the Fact Sheet (Attachment E) of this Order.

III. DISCHARGE PROHIBITIONS

- A. Wastes discharged from each of the following Discharge Points shall be limited to the type of effluent shown in the following table:

Discharge Point	Type of Effluent
001	Secondary effluent without disinfection ^a
002	Secondary effluent with disinfection ^b
003	Tertiary effluent with disinfection

- a. Secondary or tertiary effluent with disinfection may also be discharged at this location.
- b. Tertiary effluent with disinfection may also be discharged at this location.

- B. Discharge of wastewater at a location or in a manner different from that described in A. above is prohibited.
- C. The bypass or overflow of untreated wastewater or wastes to surface waters or surface water drainage courses is prohibited
- D. The discharge of any substances in concentrations toxic to animal or plant life in the affected receiving water is prohibited.
- E. There shall be no visible oil and grease in the discharge.
- F. The discharge of any radiological, chemical, or biological warfare agent or high level radiological waste is prohibited.

IV. EFFLUENT LIMITATIONS AND DISCHARGE SPECIFICATIONS

A. Effluent limitations – Discharge Points – 001, 002, and 003, beginning June 24, 2005:

- 1. The discharge of wastewater to Lucerne Valley and recycled water reuse for irrigation, construction, and wildlife habitat shall maintain compliance with the following limitations at Discharge Points 001, 002, and 003, with compliance measured at each individual monitoring location as described in the attached Monitoring and Reporting Program (Attachment D). The wastewater shall at all times be oxidized.

FOR DISCHARGE POINTS NO. 001 AND 002			
Parameter	Units	Discharge Limitations	
		Average Monthly	Average Weekly
Biochemical Oxygen Demand 5-day @ 20°C	mg/L	30	45
	lbs/day ¹	1,223	1,835
Total Suspended Solids	mg/L	30	45
	lbs/day ¹	1,223	1,835

FOR DISCHARGE POINT NO. 003			
Parameter	Units	Discharge Limitations	
		Average Monthly	Average Weekly
Biochemical Oxygen Demand 5-day @ 20°C	mg/L	20	30
	lbs/day ²	167	250
Total Suspended Solids	mg/L	20	30
	lbs/day ²	167	250

- 2. The pH of the effluent, measured at each monitoring point, shall at all times be within the range of 6 and 9 pH units.

¹ Based on a design capacity of 4.89 mgd for secondary treatment.
² Based on a design capacity of 1.0 mgd for tertiary treatment.

3. Percent Removal: The monthly average biochemical oxygen demand and suspended solids concentrations of the discharge shall not be greater than fifteen percent (15%) of the monthly average influent concentrations.
4. TDS Limitations for Discharge Points 002 and 003: for effluent limitations a. and b., below, the lower of the two total dissolved solids limits is the limit.
 - a. The 12-month average³ total dissolved solids concentration shall not exceed 550 mg/l and the 12-month flow weighted average shall not exceed 22,430 lbs/day⁴, and
 - b. The 12-month average total dissolved solids concentration shall not exceed the 12-month average total dissolved solids concentration in the water supply by more than 250 mg/l.
5. Total Inorganic Nitrogen (TIN) Limitations: The 12-month flow-weighted average TIN concentration shall not exceed 10 mg/l.
6. For Discharge from Discharge Point 003: Tertiary treated recycled water shall at all times be a filtered and subsequently disinfected wastewater that meets the following criteria:
 - a. The turbidity of the filtered wastewater does not exceed any of the following:
 - i. for micro-filtration:
 - 1). 0.2 NTU more than 5 percent of the time within a 24-hour period; and
 - 2). 0.5 NTU at any time.
 - ii. for media filtration:
 - 1). 2 NTU more than 5 percent of the time within a 24-hour period; and
 - 2). 5 NTU at any time.
 - b. Disinfected tertiary wastewater shall meet the following criteria:
 - i. The median concentration of total coliform bacteria measured in the disinfected effluent shall not exceed a most probable number (MPN) of 2.2 per 100 milliliters utilizing the bacteriological results of the last seven days for which analyses have been completed.
 - ii. The number of total coliform bacteria shall not exceed an MPN of 23 per 100 milliliters in more than one sample in any 30-day period.
 - iii. No sample shall exceed an MPN of 240 total coliform bacteria per 100 milliliters.
7. For Discharge Point 002: wastewater shall at all times be an oxidized and subsequently disinfected wastewater that meets the following criteria:
 - a. The median concentration of total coliform bacteria in the disinfected effluent shall not exceed an MPN of 23 per 100 milliliters utilizing the bacteriological results of the last seven days for which analyses have been completed⁵.

³ See Section VII. D Compliance Determination.

⁴ Calculated from 4.89 mgd x 8.34 x 550 mg/l.

- b. The number of total coliform bacteria shall not exceed an MPN of 240 per 100 milliliters in more than one sample in any 30-day period.

B. Reclamation Specifications- Discharge Points 002 and 003

1. The use of recycled water shall only commence after final approval for such use is granted by the California Department of Health Services (CDHS). The Discharger shall provide the Regional Board with a copy of the CDHS approval letter within 30 days of the approval notice.
2. The Discharger shall be responsible for assuring that recycled water is delivered and utilized in conformance with this Order, the recycling criteria contained in Title 22, Division 4, Chapter 3, Sections 60301 through 60355, California Code of Regulations, and the "Guidelines for Use of Reclaimed Water" by the California Department of Health Services. The discharger shall conduct periodic inspections of the facilities of the recycled water users to monitor compliance by the users with this Order.
3. The Discharger shall establish and enforce Rules and Regulations for Recycled Water users, governing the design and construction of recycled water use facilities and the use of recycled water in accordance with the uniform statewide recycling criteria established pursuant to the California Water Code Section 13521.
 - a. Use of recycled water by the discharger shall be consistent with its Rules and Regulations for Recycled Water Use.
 - b. Any revisions made to the Rules and Regulations shall be subject to the review of the Regional Board, the California Department of Health Services, and the County of San Bernardino Department of Environmental Health. The revised Rules and Regulations or a letter certifying that the discharger's Rules and Regulations contain the updated provisions in this Order, shall be submitted to the Regional Board within 60 days of adoption of this Order by the Regional Board.
4. The Discharger shall, within 60 days of the adoption of this Order, review and update as necessary its program to conduct compliance inspections of recycled water reuse sites. Inspections shall determine the status of compliance with the discharger's Rules and Regulations for Recycled Water Use.
5. The storage, delivery, or use of recycled water shall not individually or collectively, directly or indirectly, result in a pollution or nuisance, or adversely affect water quality, as defined in the California Water Code

⁵ Title 22, 60301.225.

6. Prior to delivering recycled water to any new individual residential user, small commercial, or construction project users in accordance with BBARWA's "Temporary Use Policy for Private Residences", the discharger shall obtain items a. through f. listed below for review and approval by the discharger's supervisor responsible for the operation of the recycled water distribution system. For all other new users, the discharger shall submit to the California Department of Health Services for review and approval a report containing items a. through f. listed below:
 - a. The average number of persons estimated to be served at each use site area on a daily basis.
 - b. The specific boundaries of the proposed use site area including a map showing the location of each facility, drinking water fountain, and impoundment to be used.
 - c. The person or persons responsible for operation of the recycled water system at each use area.
 - d. The specific use to be made of the recycled water at each use area.
 - e. The methods to be used to assure that the installation and operation of the recycled system will not result in cross connections between the recycled water and potable water piping systems. This shall include a description of the pressure, dye or other test methods to be used to test the system.
 - f. Plans and specifications which include following:
 - i. Proposed piping system to be used.
 - ii. Pipe locations of both the recycled and potable systems.
 - iii. Type and location of the outlets and plumbing fixtures that will be accessible to the public.
 - iv. The methods and devices to be used to prevent backflow of recycled water into the potable water system.
 - v. Plan notes relating to specific installation and use requirements.
7. The user shall designate an on-site supervisor responsible for the operation of the recycled water distribution system. The supervisor shall be responsible for enforcing this Order, prevention of potential hazards, the installation, operation and maintenance of the distribution system, maintenance of the distribution and irrigation system plans in "as-built" form, and for the distribution of the recycled wastewater in accordance with this Order.

V. RECEIVING WATER LIMITATIONS

A. Groundwater Limitations

1. The discharge shall not cause the underlying groundwater to be degraded, to exceed water quality objectives, unreasonably affect beneficial uses, or cause a condition of pollution or nuisance.

2. The discharge, in combination with other sources, shall not cause underlying groundwater to contain waste constituents in concentrations greater than background water quality.

VI. PROVISIONS

A. General Provisions:

1. Neither the treatment nor the discharge of waste shall create, or threaten to create, a nuisance or pollution as defined by Section 13050 of the California Water Code.
2. The discharger shall maintain a copy of this Order at the site so that it is available to site operating personnel at all times. Key operating personnel shall be familiar with its content.
3. The discharger shall take all reasonable steps to minimize any adverse impact to receiving waters resulting from noncompliance with any requirements specified in this Order, including such accelerated or additional monitoring as necessary to determine the nature and impact of the noncomplying discharge.
4. The discharger shall optimize chemical additions needed in the treatment process to meet waste discharge requirements so as to minimize total dissolved solid increases in the recycled water.
5. The provisions of this Order are severable, and if any provision of this Order, or the application of any provisions of this Order to any circumstance, is held invalid, the application of such provision to other circumstances, and the remainder of this Order shall not be affected thereby.
6. Collected screenings, sludge, and other solids removed from liquid wastes shall be disposed of in a manner approved by the Regional Board's Executive Officer.
7. If the discharger demonstrates a correlation between the biological oxygen demand (BOD5) and total organic carbon (TOC) concentrations in the effluent to the satisfaction of the Executive Officer, compliance with the BOD5 limits contained in this Order may be determined based on analyses of the TOC of the effluent.
8. In the event of any change in control or ownership of land or waste discharge facility presently owned or controlled by the discharger, the discharger shall notify the succeeding owner or operator of the existence of this Order by letter, a copy of which shall be forwarded to the Regional Board.
9. The treatment facilities shall be designed, constructed, operated, and maintained to prevent inundation or washout due to floods with a 100-year return frequency.

B. Monitoring and Reporting Program Requirements

The Discharger shall comply with the Monitoring and Reporting Program, and future revisions thereto, in Attachment D of this Order. This monitoring and reporting program may be modified by the Executive Officer at any time during the term of this Order, and may include an increase or a reduction in the number of parameters to be monitored, the frequency of the monitoring or the number and size of samples to be collected. Any increase in the number of parameters to be monitored, the frequency of the monitoring or the number and size of samples to be collected may be reduced back to the levels specified in the original monitoring and reporting program at the discretion of the Executive Officer.

C. Special Provisions

1. Construction, Operation and Maintenance Specifications

- a. The discharger's wastewater treatment plant shall be supervised and operated by persons possessing certificates of appropriate grade pursuant to Title 23, Division 3, Chapter 14, California Code of Regulations.
- b. The discharger shall provide safeguards to assure that should there be reduction, loss, or failure of electric power, the discharger will comply with the requirements of this Order.
- c. The discharger shall update as necessary, the "Operation and Maintenance Manual (O&M Manual)" which it has developed for the treatment facility to conform to latest plant changes and requirements. The O&M Manual shall be readily available to operating personnel onsite. The O&M Manual shall include the following:
 - i. Description of the treatment plant table of organization showing the number of employees, duties and qualifications and plant attendance schedules (daily, weekends and holidays, part-time, etc). The description should include documentation that the personnel are knowledgeable and qualified to operate the treatment facility so as to achieve the required level of treatment at all times.
 - ii. Detailed description of safe and effective operation and maintenance of treatment processes, process control instrumentation and equipment.
 - iii. Description of laboratory and quality assurance procedures.
 - iv. Process and equipment inspection and maintenance schedules.
 - v. Description of safeguards to assure that, should there be reduction, loss, or failure of electric power, the discharger will be able to comply with requirements of this Order.

- vi. Description of preventive (fail-safe) and contingency (response and cleanup) plans for controlling accidental discharges, and for minimizing the effect of such events. These plans shall identify the possible sources (such as loading and storage areas, power outage, waste treatment unit failure, process equipment failure, tank and piping failure) of accidental discharges, untreated or partially treated waste bypass, and polluted drainage.

2. Special Provisions for Municipal Facilities (POTWs Only)

a. Sludge Disposal Requirements

- i. Collected screenings, biosolids, and other solids removed from liquid wastes shall be disposed of in a manner that is consistent with Chapter 15, Division 3, Title 23, of the California Code of Regulations and approved by the Executive Officer.
- ii. The use and disposal of biosolids shall comply with existing Federal and State laws and regulations, including permitting requirements and technical standards included in 40 CFR 503.
- iii. Any proposed change in biosolids use or disposal practice from a previously approved practice shall be reported to the Executive Officer and EPA Regional Administrator at least 90 days in advance of the change.
- iv. The discharger shall take all reasonable steps to minimize or prevent any discharge or biosolids use or disposal that has the potential of adversely affecting human health or the environment.

VII. COMPLIANCE DETERMINATION

Compliance with the effluent limitations contained in Section IV of this Order will be determined as specified below:

A. Average Monthly Effluent Limitation (AMEL).

If the average of daily discharges over a calendar month exceeds the AMEL for a given parameter, an alleged violation will be flagged and the Discharger will be considered out of compliance for each day of that month for that parameter (e.g., resulting in 31 days of non-compliance in a 31-day month). The average of daily discharges over the calendar month that exceeds the AMEL for a parameter will be considered out of compliance for that month only. If only a single sample is taken during the calendar month and the analytical result for that sample exceeds the AMEL, the Discharger will be considered out of compliance for that calendar month. For any one calendar month during which no sample (daily discharge) is taken, no compliance determination can be made for that calendar month.

B. Average Weekly Effluent Limitation (AWEL).

If the average of daily discharges over a calendar week exceeds the AWEL for a given parameter, an alleged violation will be flagged and the Discharger will be considered out of compliance for each day of that week for that parameter, resulting in 7 days of non-compliance. The average of daily discharges over the calendar week that exceeds the AWEL for a parameter will be considered out of compliance for that week only.

If only a single sample is taken during the calendar week and the analytical result for that sample exceeds the AWEL, the Discharger will be considered out of compliance for that calendar week. For any one calendar week during which no sample (daily discharge) is taken, no compliance determination can be made for that calendar week.

C. Maximum Daily Effluent Limitation (MDEL).

If a daily discharge exceeds the MDEL for a given parameter, an alleged violation will be flagged and the Discharger will be considered out of compliance for that parameter for that 1 day only within the reporting period. For any 1 day during which no sample is taken, no compliance determination can be made for that day.

D. Compliance with the 12-month flow weighted average limit under Effluent Limitations.

A. 4. shall be determined by the arithmetic mean of the last twelve monthly averages.

E. Time Interval.

Compliance determinations shall be based on available analyses for the time interval associated with the effluent limitation. Where only one sample analysis is available in a specified time interval (e.g., monthly or weekly average), that sample shall serve to characterize the discharge for the entire interval. If quarterly sample results show noncompliance with the average monthly limit and that sample result is used for compliance determinations for each month of the quarter, then three separate violations of the average monthly limit shall be deemed to have occurred.

F. For Non-Priority Pollutants.

The discharge shall be considered to be in compliance with an effluent limitation, which is less than or equal to the PQL specified in Attachment D of M&RP No. R8-2005-44 if the arithmetic mean of all test results for the monitoring period is less than the constituent effluent limitation. Analytical results that are less than the specified PQL shall be assigned a value of zero.

ATTACHMENT A – DEFINITIONS

Average Monthly Effluent Limitation (AMEL): the highest allowable average of daily discharges over a calendar month, calculated as the sum of all daily discharges measured during a calendar month divided by the number of daily discharges measured during that month.

Average Weekly Effluent Limitation (AWEL): the highest allowable average of daily discharges over a calendar week (Sunday through Saturday), calculated as the sum of all daily discharges measured during a calendar week divided by the number of daily discharges measured during that week.

Daily Discharge: Daily Discharge is defined as either: (1) the total mass of the constituent discharged over the calendar day (12:00 am through 11:59 pm) or any 24-hour period that reasonably represents a calendar day for purposes of sampling (as specified in the Order), for a constituent with limitations expressed in units of mass or; (2) the unweighted arithmetic mean measurement of the constituent over the day for a constituent with limitations expressed in other units of measurement (e.g., concentration).

The daily discharge may be determined by the analytical results of a composite sample taken over the course of one day (a calendar day or other 24-hour period defined as a day) or by the arithmetic mean of analytical results from one or more grab samples taken over the course of the day.

For composite sampling, if 1 day is defined as a 24-hour period other than a calendar day, the analytical result for the 24-hour period will be considered as the result for the calendar day in which the 24-hour period ends.

Maximum Daily Effluent Limitation (MDEL): the highest allowable daily discharge of a pollutant.

ATTACHMENT B – TOPOGRAPHIC MAP



ATTACHMENT C – FLOW SCHEMATIC

FACILITY DESIGNATION

- | | |
|---|--|
| ② HEADWORKS BUILDING | ②① EMERGENCY HOLDING POND |
| ⑦ SLUDGE BUILDING | ②② PAVED SLUDGE DRYING AREA |
| ⑨ OXIDATION DITCH/NUTRIENT REMOVAL SYSTEM | ②③ FILTERS/UV OR CHLORINATION FACILITY |
| ⑫ CLARIFIER | ②⑥ SAMPLING/MONITORING LOCATION M001 -- BOD/TSS |
| ⑭ BALANCING CHAMBERS/RECYCLED WATER STORAGE TANKS | ②⑦ SAMPLING/MONITORING LOCATION M002 -- COLIFORM |
| ⑯ HORSESHOE STORAGE POND | ②⑧ SAMPLING/MONITORING LOCATION M003 -- COLIFORM/TURBIDITY |
| ⑰ MAIN EFFLUENT PUMP, WAS AND RAS PUMP STATION | ③① DISCHARGE POINT 003 |
| ⑱ AUXILIARY EFFLUENT PUMP STATION | ③② DISCHARGE POINT 001 |
| ⑲ SLUDGE DEWATERING BEDS | ③③ SAMPLING/MONITORING LOCATION M--INF |
| ⑳ WILDLIFE HABITAT AREA | |

TREATMENT PROCESS FLOW SCHEMATIC

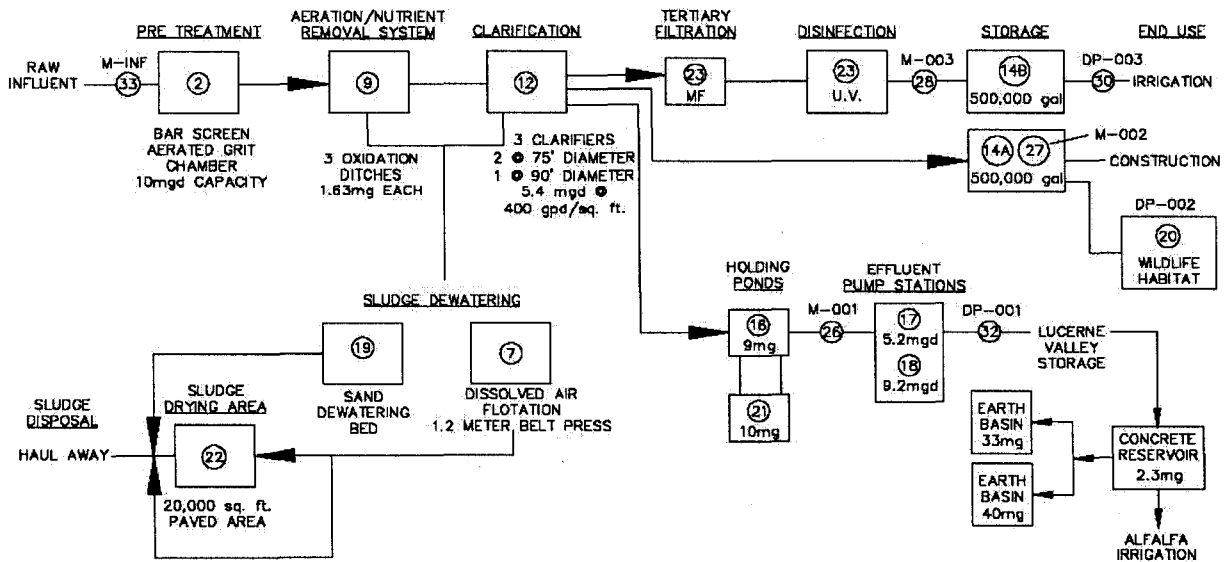

**BIG BEAR AREA REGIONAL WASTEWATER AGENCY
 PROCESS FLOW DIAGRAM**

Attachment D – Monitoring and Reporting Program – Table of Contents

Attachment D– Monitoring and Reporting Program (MRP) 2

I. General Monitoring Provisions..... 2

II. Monitoring Locations..... 3

III. Influent Monitoring Requirements 3

 Monitoring Location M-INF..... 3

IV. Effluent Monitoring Requirements 4

 Monitoring Locations at M-001, M-002, and M-003 4

V. Reclamation Monitoring Requirements 5

VI. Other Monitoring Requirements 5

VII. Reporting Requirements 6

 A. Reporting Requirements..... 6

 B. Self Monitoring Reports (SMRs) 8

VIII. PQL and EPA PPL.....10

ATTACHMENT D– MONITORING AND REPORTING PROGRAM (MRP)

CWC sections 13267 and 13383 authorize the Regional Water Quality Control Board (RWQCB) to require technical and monitoring reports. This MRP establishes monitoring and reporting requirements, that implement California regulations.

I. GENERAL MONITORING PROVISIONS

- A. All sampling and sample preservation shall be in accordance with the current edition of “Standard Methods for the Examination of Water and Wastewater” (American Public Health Association).
- B. Chemical, bacteriological, and bioassay analyses shall be conducted at a laboratory certified for such analyses by the State Department of Health Services or at laboratories approved by the Regional Board's Executive Officer.
- C. The discharger shall have and implement an acceptable written quality assurance (QA) plan for laboratory analyses. Duplicate chemical analyses must be conducted on a minimum of ten percent (10%) of the samples, or at least one sample per month, whichever is greater. A similar frequency shall be maintained for analyzing spiked samples.
- D. The flow measurement system shall be calibrated at least once per year or more frequently, to ensure continued accuracy.
- E. All monitoring instruments and devices used by the discharger to fulfill the prescribed monitoring program shall be properly maintained and calibrated as necessary to ensure their continued accuracy. In the event that continuous monitoring equipment is out of service for greater than a 24-hour period, the discharger shall obtain a representative grab sample each day the equipment is out of service. The discharger shall correct the cause(s) of failure of the continuous monitoring equipment as soon as practicable. In its monitoring report, the discharger shall specify the period(s) during which the equipment was out of service and if the problem has not been corrected, shall identify the steps which the discharger is taking or proposes to take to bring the equipment back into service and the schedule for these actions.
- F. Monitoring and reporting shall be in accordance with the following:
 - 1. Samples and measurements taken for the purpose of monitoring shall be representative of the monitored activity.
 - 2. The monitoring and reporting of influent, effluent, and sludge shall be done more frequently as necessary to maintain compliance with this Order and or as specified in this Order.
 - 3. Whenever the discharger monitors any pollutant more frequently than is required by this Order, the results of this monitoring shall be included in the calculation and reporting of the data submitted in the discharge monitoring report specified by the Executive Officer.
 - 4. A "grab" sample is defined as any individual sample collected in less than 15 minutes.

5. A composite sample is defined as a combination of no fewer than eight individual grab samples obtained over the specified sampling period. The volume of each individual grab sample shall be proportional to the discharge flow rate at the time of sampling. The compositing period shall equal the specific sampling period, or 24 hours, if no period is specified.
6. 24-hour composite samples shall be collected continuously during a 24-hour operation of the facility.
7. Daily samples shall be collected on each day of the week.
8. Monthly samples shall be collected on any representative day of each month.
9. Quarterly samples shall be collected by any representative day of March, June, September, and December.
10. Annual priority pollutant samples shall be collected in December.

II. MONITORING LOCATIONS

The Discharger shall establish the following monitoring locations to demonstrate compliance with the effluent limitations, discharge specifications, and other requirements in this Order:

Discharge Point Name	Monitoring Location Name	Monitoring Location Description
--	M-INF #33	Influent line before Barscreen
001	M-001 #26	Junction Manhole after Holding Ponds
002	M-002 #27	South Balancing Chamber, Pond 14A
003	M-003 #28	Effluent line before pond 14B
--	S-001	Water Supply

III. INFLUENT MONITORING REQUIREMENTS

Monitoring Location M-INF

The Discharger shall monitor the **influent to the facility** at **Monitoring Location M-INF** as follows:

Parameter	Units	Sample Type	Minimum Sampling Frequency
Flow	MGD	Recorder	Continuous
Biochemical Oxygen Demand ₅	mg/l	24-Hour Composite	Monthly
Suspended Solids	mg/l	24-Hour Composite	Monthly

IV. EFFLUENT MONITORING REQUIREMENTS

Monitoring Locations at M-001, M-002, and M-003

The Discharger shall monitor the effluent at the Monitoring Locations listed above for the following constituents:

Parameter	Units	Sample type	Minimum Sampling Frequency	Sample Location
Flow ¹	MGD	Recorder/totalizer	Continuous	-----
Turbidity ²	NTU	Recorder	Continuous	M-003
pH	pH unit	Recorder	Continuous	M-001
pH ³	pH unit	Grab	Daily	M-002 or M-003
Specific Conductivity	µmhos	Grab	Daily	M-001; M-002 ³ ; M-003 ³
Total Coliform Organisms ³	MPN per 100m/l	Grab	Daily	M-002 M-003
Biochemical Oxygen Demand ₅	mg/l	24-Hour composite	Weekly	M-001 ⁴ M-003 ⁵
Total Suspended Solids	mg/l	24-Hour composite	Weekly	M-001 ⁴ M-003 ⁵
Total Inorganic Nitrogen	mg/l	24-Hour composite	Monthly	M-001
Total Dissolved Solids ³	mg/l	24-Hour composite	Monthly	M-002; M-003
Hardness	mg/l	24-Hour composite	Quarterly	M-001
Sodium	mg/l	24-Hour composite	Quarterly	M-001
Chloride	mg/l	24-Hour composite	Quarterly	M-001
Sulfate	mg/l	24-Hour composite	Quarterly	M-001
Total Phosphorous	mg/l	24-Hour composite	Monthly	M-001
EPA Priority Pollutants Metals (items #1-#13) see attachment D-11	µg/l		Annually	M-001
Remaining EPA Priority Pollutants (Volatile Organics items #17-#55)-see attachment D-11	µg/l	Grab	Annually	M-001

- 1 The daily flow to each discharge point shall be recorded.
- 2 Whenever recycled water is discharged or used at Discharge Serial No. 003.
- 3 Whenever recycled water is discharged or used at Discharge Serial No. 002 or 003.
- 4 The weekly 24-Hour composite sample for BOD₅ and TSS taken from sample location M-001 shall be representative of Serial Discharge No. 001 and 002.
- 5 The weekly 24-Hour composite sample for BOD₅ and TSS taken from sample location M-003 whenever recycled water is discharged or used at Serial Discharge No. 003.

V. RECLAMATION MONITORING REQUIREMENTS

Whenever recycled water is supplied to a user, the volume and type of recycled water, the user of recycled water, the locations of those sites including the names of the groundwater management zone underlying the recycled water use sites, type of use (e.g. irrigation, industrial, etc) and the dates at which water is supplied shall be recorded. A summary report of water use by groundwater management zones shall be submitted quarterly. This report shall be included in the annual report.

VI. OTHER MONITORING REQUIREMENTS

A. WATER SUPPLY MONITORING

1. Once every three years, a sample of each source of the water supplied to the sewer area shall be obtained and analyzed for the following constituents:

Specific Conductance	Total Dissolved Solids	pH
Sodium	Total Hardness	
Chloride	Nitrate	

2. All of the above constituents shall be expressed in "mg/l" except specific conductance and pH, which shall be expressed in "micromhos/cm" and "pH units," respectively.
3. Monthly reports shall be submitted stating the amount (in percentage or acre-feet) supplied to the sewer area from each source of water and the resulting flow-weighted water supply quality for total dissolved solids, chloride, nitrate, sodium, and total hardness.

B. BIOSOLIDS MONITORING

The discharger shall maintain a permanent log of solids hauled away from the treatment facilities for use/disposal elsewhere, including the date hauled, the volume or weight (in dry tons), type (screening, grit), and destination. This information shall be reported annually.

VII. REPORTING REQUIREMENTS

A. Reporting Requirements

1. All analytical data shall be reported with method detection limit¹ (MDLs) and with identification of either practical quantitation levels (PQLs²) or limits of quantitation (LOQs).
2. Laboratory data for effluent samples must quantify each constituent down to the PQLs specified in Attachment "D-9" or to lower PQLs achieved by the discharger. Any internal quality control data associated with the sample must be reported when requested by the Executive Officer. The Regional Board will reject the quantified laboratory data if quality control data is unavailable or unacceptable.
3. Discharge monitoring data shall be submitted in a format acceptable by the Regional Board. Specific reporting format may include preprinted forms and/or electronic media. The results of all monitoring required by this Order shall be reported to the Regional Board, and shall be submitted in such a format as to allow direct comparison with the limitations and requirements of this order.
4. The discharger shall tabulate the monitoring data to clearly illustrate compliance and/or noncompliance with the requirements of the Order.
5. For every item of monitoring data where the requirements are not met, the monitoring report shall include a statement discussing the reasons for noncompliance, and of the actions undertaken or proposed which will bring the discharge into full compliance with requirements at the earliest time, and an estimate of the date when the discharger will be in compliance. The discharger shall notify the Regional Board by letter when compliance with the time schedule has been achieved.
6. The reports for December shall include a roster of plant personnel, including job titles, duties, and level of State certification for each individual.
7. By March 1 of each year, the discharger shall submit an annual report to the Regional Board. The report shall contain both tabular and graphical summaries of the monitoring data obtained during the previous year. In addition, the discharger shall discuss the compliance record and the corrective actions taken or planned that may be needed to bring the discharge into full compliance with the waste discharge requirements. The annual report shall include a summary of the quality assurance (QA) activities for the previous year.

¹ The standardized test procedure to be used to determine the method detection limit (MDL) is given at Appendix B, 'Definition and Procedure for the Determination of the Method Detection Limit' of 40 CFR 136.

² PQL is the lowest concentration of a substance which can be determined within ± 20 percent of the true concentration by 75 percent of the analytical laboratories tested in a performance evaluation study. Alternatively, if performance data are not available, the PQL is the method detection limit (MDL) x 5 for carcinogens and MDL x 10 for noncarcinogens.

8. The discharger shall assure that records of all monitoring information are maintained and accessible for a period of at least five years from the date of the sample, report, or application. This period of retention shall be extended during the course of any unresolved litigation regarding this discharge or by the request of the Regional Board at any time. Records of monitoring information shall include:
 - a. The date, exact place, and time of sampling or measurements;
 - b. The individual(s) who performed the sampling, and/or measurements;
 - c. The laboratory which performed the analyses;
 - d. The date(s) analyses were performed;
 - e. The individual(s) who performed the analyses;
 - f. The analytical techniques or methods used, including any modification to those methods;
 - g. All sampling and analytical results, including
 - i. units of measurement used;
 - ii. minimum reporting limit for the analysis (minimum level, practical quantitation level (PQL));
 - iii. results less than the reporting limit but above the method detection limit (MDL);
 - iv. data qualifiers and a description of the qualifiers;
 - v. quality control test results (and a written copy of the laboratory quality assurance plan);
 - vi. dilution factors, if used; and
 - vii. sample matrix type.
 - h. All monitoring equipment calibration and maintenance records;
 - i. All original strip charts from continuous monitoring devices;
 - j. All data used to complete the application for this Order; and,
 - k. Copies of all reports required by this Order.
 - l. Electronic data and information generated by the Supervisory Control And Data Acquisition (SCADA) System.
9. All reports and/or information submitted to the Regional Board shall be signed by a responsible officer or duly authorized representative of the discharger and shall be submitted under penalty of perjury.
10. The discharger, unless otherwise specified elsewhere in this M&RP, shall deliver a copy of each monitoring report in the appropriate format to:

California Regional Water Quality Control Board
Santa Ana Region
3737 Main Street, Suite 500
Riverside, CA 92501-3348

B. Self Monitoring Reports (SMRs)

1. At any time during the term of this Order, the State or Regional Water Board may notify the Discharger to electronically submit self-monitoring reports. Until such notification is given, the Discharger shall submit self-monitoring reports in accordance with the requirements described below.
2. The Discharger shall submit quarterly and annual Self Monitoring Reports including the results of all required monitoring using USEPA-approved test methods or other test methods specified in this Order. Quarterly reports shall be due on May 1, August 1, November 1, and February 1 following each calendar quarter; Annual reports shall be due on March 1 following each calendar year.
3. Monitoring periods and reporting for all required monitoring shall be completed according to the following schedule:

Sampling Frequency	Monitoring Period Begins On...	Monitoring Period	SMR Due Date
Continuous	June 24, 2005	All	May 1 August 1 November 1 February 1
1 / day	June 24, 2005	Midnight through 11:59 PM or any 24-hour period that reasonably represents a calendar day for purposes of sampling.	"
1 / week	Sunday following June 24, 2005 or on June 24, 2005 if on a Sunday	Sunday through Saturday	"
1 / month	First day of calendar month following June 24, 2005	1 st day of calendar month through last day of calendar month	"
1 / quarter	Closest of January 1, April 1, July 1, or October 1 following June 24, 2005	January 1 through March 31 April 1 through June 30 July 1 through September 30 October 1 through December 31	May 1 August 1 November 1 February 1
1 / year	January 1 following June 24, 2005	January 1 through December 31	March 1

5. The Discharger shall arrange all reported data in a tabular format. The data shall be summarized to clearly illustrate whether the facility is operating in compliance with interim and/or final effluent limitations.
6. The Discharger shall attach a cover letter to the SMR. The information contained in the cover letter shall clearly identify violations of the WDRs; discuss corrective actions taken or planned; and the proposed time schedule for corrective actions. Identified violations must include a description of the requirement that was violated and a description of the violation.

7. SMRs must be submitted to the Regional Water Board, signed and certified to the address listed below:

Gerard J. Thibeault, Executive Officer
California Regional Water Quality Control Board
Santa Ana Region
3737 Main Street, Suite 500
Riverside, CA 92501-3348

VIII. PQL and EPA PPL

PRACTICAL QUANTITATION LEVELS FOR COMPLIANCE DETERMINATION			
	Constituent	RL, µg/l	Analysis Method
1	Arsenic	7.5	GF/AA
2	Barium	20	ICP/GFAA
3	Cadmium	15	ICP
4	Chromium (VI)	15.0	ICP
5	Cobalt	10.0	GF/AA
6	Copper	19.0	GF/ICP
7	Cyanide	50.0	335.2/335.3
8	Iron	100.0	ICP
9	Lead	26.0	GF/AA
10	Manganese	20.0	ICP
11	Mercury	0.5	CV/AA
12	Nickel	50.0	ICP
13	Selenium	14.0	GF/HYDRIDE GENERATION
14	Silver	16.0	ICP
15	Zinc	20	ICP
16	1,2 - Dichlorobenzene	5.0	601/602/624
17	1,3 - Dichlorobenzene	5.0	601
18	1,4 - Dichlorobenzene	5.0	601
18	2,4 - Dichlorophenol	10.0	625/604
20	4 - Chloro -3- methylphenol	10.0	625/604
21	Aldrin	0.04	608
22	Benzene	1.0	602/624
23	Chlordane	0.30	608
24	Chloroform	5.0	601/624
25	DDT	0.10	608
26	Dichloromethane	5.0	601/624
27	Dieldrin	0.10	608
28	Fluorantene	10.0	625/610
29	Endosulfan	0.50	608
30	Endrin	0.10	608
31	Halomethanes	5.0	601/624
32	Heptachlor	0.03	608
33	Hepthachlor Epoxide	0.05	608
34	Hexachlorobenzene	10.0	625
35	Hexachlorocyclohexane		
	Alpha	0.03	608
	Beta	0.03	608
	Gamma	0.03	608
36	PAH's	10.0	625/610
37	PCB	1.0	608
38	Pentachlorophenol	10.0	625/604
39	Phenol	10.0	625/604
40	TCDD Equivalent	0.05	8280
41	Toluene	1.0	602/625
42	Toxaphene	2.0	608
43	Tributyltin	0.02	GC
44	2,4,6-Trichlorophenol	10.0	625/604

EPA PRIORITY POLLUTANT LIST

Metals		Acid Extractibles		Base/Neutral Extractibles (continuation)	
1. Antimony		45. 2-Chlorophenol		91. Hexachloroethane	
2. Arsenic		46. 2,4-Dichlorophenol		92. Indeno (1,2,3-cd) Pyrene	
3. Beryllium		47. 2,4-Dimethylphenol		93. Isophorone	
4. Cadmium		48. 2-Methyl-4,6-Dinitrophenol		94. Naphthalene	
5a. Chromium (III)		49. 2,4-Dinitrophenol		95. Nitrobenzene	
5b. Chromium (VI)		50. 2-Nitrophenol		96. N-Nitrosodimethylamine	
6. Copper		51. 4-Nitrophenol		97. N-Nitrosodi-N-Propylamine	
7. Lead		52. 3-Methyl-4-Chlorophenol		98. N-Nitrosodiphenylamine	
8. Mercury		53. Pentachlorophenol		99. Phenanthrene	
9. Nickel		54. Phenol		100. Pyrene	
10. Selenium		55. 2, 4, 6 – Trichlorophenol		101. 1,2,4-Trichlorobenzene	
11. Silver		Base/Neutral Extractibles		Pesticides	
12. Thallium		56. Acenaphthene		102. Aldrin	
13. Zinc		57. Acenaphthylene		103. Alpha BHC	
Miscellaneous		58. Anthracene		104. Beta BHC	
14. Cyanide		59. Benzidine		105. Delta BHC	
15. Asbestos (not required unless requested)		60. Benzo (a) Anthracene		106. Gamma BHC	
16. 2,3,7,8-Tetrachlorodibenzo-P-Dioxin (TCDD)		61. Benzo (a) Pyrene		107. Chlordane	
Volatile Organics		62. Benzo (b) Fluoranthene		108. 4, 4' - DDT	
17. Acrolein		63. Benzo (g,h,i) Perylene		109. 4, 4' - DDE	
18. Acrylonitrile		64. Benzo (k) Fluoranthene		110. 4, 4' - DDD	
19. Benzene		65. Bis (2-Chloroethoxy) Methane		111. Dieldrin	
20. Bromoform		66. Bis (2-Chloroethyl) Ether		112. Alpha Endosulfan	
21. Carbon Tetrachloride		67. Bis (2-Chloroisopropyl) Ether		113. Beta Endosulfan	
22. Chlorobenzene		68. Bis (2-Ethylhexyl) Phthalate		114. Endosulfan Sulfate	
23. Chlorodibromomethane		69. 4-Bromophenyl Phenyl Ether		115. Endrin	
24. Chloroethane		70. Butylbenzyl Phthalate		116. Endrin Aldehyde	
25. 2-Chloroethyl Vinyl Ether		71. 2-Chloronaphthalene		117. Heptachlor	
26. Chloroform		72. 4-Chlorophenyl Phenyl Ether		118. Heptachlor Epoxide	
27. Dichlorobromomethane		73. Chrysene		119. PCB 1016	
28. 1,1-Dichloroethane		74. Dibenzo (a,h) Anthracene		120. PCB 1221	
29. 1,2-Dichloroethane		75. 1,2-Dichlorobenzene		121. PCB 1232	
30. 1,1-Dichloroethylene		76. 1,3-Dichlorobenzene		122. PCB 1242	
31. 1,2-Dichloropropane		77. 1,4-Dichlorobenzene		123. PCB 1248	
32. 1,3-Dichloropropylene		78. 3,3'-Dichlorobenzidine		124. PCB 1254	
33. Ethylbenzene		79. Diethyl Phthalate		125. PCB 1260	
34. Methyl Bromide		80. Dimethyl Phthalate		126. Toxaphene	
35. Methyl Chloride		81. Di-n-Butyl Phthalate		<p>Note: All laboratory analyses shall be performed in accordance with test procedures under 40 CFR 136 (latest edition) and shall meet the minimum levels specified in Appendix 4 of the Policy for Implementation of Toxics Standards for Inland Surface Waters, Enclosed Bays, and Estuaries of California</p> <p>Revised: 1/12/2005</p>	
36. Methylene Chloride		82. 2,4-Dinitrotoluene			
37. 1,1,2,2-Tetrachloroethane		83. 2-6-Dinitrotoluene			
38. Tetrachloroethylene		84. Di-n-Octyl Phthalate			
39. Toluene		85. 1,2-Dipenylhydrazine			
40. 1,2-Trans-Dichloroethylene		86. Fluoranthene			
41. 1,1,1-Trichloroethane		87. Fluorene			
42. 1,1,2-Trichloroethane		88. Hexachlorobenzene			
43. Trichloroethylene		89. Hexachlorobutadiene			
44. Vinyl Chloride		90. Hexachlorocyclopentadiene			

Attachment E – Fact Sheet – Table of Contents

Attachment E – Fact Sheet..... 2

I. Order Information 2

II. Facility Description..... 3

 A. Description of Wastewater and Biosolids Treatment or Controls..... 3

 B. Discharge Points and Receiving Waters 4

 C. Stormwater Runoff from this Facility 5

 D. Summary of Existing Requirements and Self-Monitoring Report (SMR) Data 5

 E. Compliance Summary 6

 F. Planned Changes 6

III. Applicable Plans, Policies, and Regulations..... 7

 A. Legal Authorities 7

 B. California Environmental Quality Act (CEQA)..... 7

 C. State Regulations, Policies, and Plans 7

 D. Industrial Stormwater Requirements..... 8

IV. Rationale For Effluent Limitations and Discharge Specifications 9

 A. Technology-Based Effluent Limitations 9

 1. Scope and Authority 9

 2. Applicable Technology-Based Effluent Limitations 9

 B. Water Quality-Based Effluent Limitations (WQBELs) 10

 C. Reclamation Specifications 10

 D. Final Effluent Limitations 10

V. Rationale for Receiving Water Limitations 12

 A. Surface Water 12

 B. Groundwater 12

VI. Rationale for Monitoring and Reporting Requirements 12

 A. Influent Monitoring 13

 B. Effluent Monitoring..... 13

VII. Public Participation..... 13

 A. Notification of Interested Parties..... 13

 B. Written Comments 13

 C. Public Hearing..... 13

 D. Waste Discharge Requirements Petitions..... 14

 E. Information and Copying 14

 F. Register of Interested Persons 14

 G. Additional Information..... 14

ATTACHMENT E – FACT SHEET

As described in Section II of this Order, this Fact Sheet includes the legal requirements and technical rationale that serve as the basis for the requirements of this Order.

I. ORDER INFORMATION

The following table summarizes administrative information related to the facility.

WDID	8 360108001
Discharger	Big Bear Area Regional Wastewater Agency
Name of Facility	Regional Treatment Plant, Big Bear City
Facility Address	122 Palomino Drive
	Big Bear City, CA 92314
	San Bernardino
Facility Contact, Title and Phone	Joseph Hanford, Interim Plant Superintendent (909) 584-4018
Authorized Person to Sign and Submit Reports	Steven Schindler, General Manager, (909) 584-4018 Joseph Hanford, Interim Plant Superintendent
Mailing Address	P. O. BOX 517, 122 Palomino Drive, Big Bear City, Ca 92314
Billing Address	SAME
Type of Facility	POTW
Major or Minor Facility	Major
Threat to Water Quality	2
Complexity	B
Pretreatment Program	N
Reclamation Requirements	Producer/User
Facility Permitted Flow	4.89 mgd
Facility Design Flow	4.89 mgd
Watershed	Big Bear Lake
Receiving Water	pond in the Baldwin lake, Big Bear Valley Groundwater management zone
Receiving Water Type	surface water in the state and groundwater

- A. Big Bear Area Regional Wastewater Agency (hereinafter Discharger) is the owner and operator of Regional Treatment Plant (hereinafter Facility), a POTW.
- B. The Facility discharges wastewater to ponds and irrigation and construction sites that overlie the Lucerne Hydrologic Unit (Region 7) or the Big Bear Valley groundwater management zone. The discharges are currently regulated by Order No. 00-12, which was adopted on February 25, 2000 and expired on February 1, 2005.

- C. The Discharger filed a report of waste discharge and submitted an application for renewal of its Waste Discharge Requirements (WDRs) on August 25, 2004. Supplemental Information was requested on January 14, 2005 and following in February 2005. Information was received on January and February 2005. A site visit was conducted on April 11, 2005, to observe operations and collect additional data to develop limitations and conditions.

II. FACILITY DESCRIPTION

A. Description of Wastewater and Biosolids Treatment or Controls

Big Bear Area Regional Wastewater Agency (BBARWA) is a joint powers authority consisting of Big Bear City Community Services District, City of Big Bear Lake and San Bernardino County Service Area 53-B. BBARWA owns and operates a Regional Treatment Plant (RTP) located at 122 Palomino Drive, Big Bear City, in the SW¹/₄ of Section 7, T2N, R2E, SBB&N. The RTP is adjacent to the Baldwin Lake and protected by a dike. The RTP is located at elevation of approximately 6714 feet, which is 3 feet above the estimated 100-year flood elevation of the Baldwin Lake.

Discharges from the facility are currently regulated under Order No. 00-12, NPDES No. CA80000344. That Order expired on February 1, 2005 and was not administratively extended. On August 26, 2004, BBARWA submitted a Report of Waste Discharge for the renewal of waste discharge requirements for BBARWA's Regional Treatment Plant (RTP).

The RTP treats commercial and domestic wastes from the City of Big Bear Lake, Big Bear City Community Services District and County Service Area 53-B. In 2003, the total equivalent dwelling units (EDUs) in the service area were 23,800 units with an estimated population of 59,500 on full or part time basis.

The RTP is designed to secondarily treat up to 4.89 million gallons per day (mgd) of wastewater and tertiary treat up to 1.0 mgd of wastewater. The RTP currently treats an annual average flow at 2.2 mgd. Of the effluent flow, up to 0.07 mgd is for recycled water reuse in the Big Bear area and up to 2 mgd is used for irrigation of alfalfa in Lucerne Valley.

The RTP treatment system consists of the following:

1. Preliminary treatment consists of bar screens and an aerated grit chamber;
2. Secondary treatment utilizes oxidation ditches, secondary clarifiers, and symbio process for nutrient removal;
3. Tertiary treatment consists of micro-filtration and/or 6 gpm reverse osmosis;
4. Disinfection of secondary treated effluent is done by chlorination while tertiary treated effluent is disinfected through ultraviolet light;
5. Sludge treatment system consists of sand dewatering bed, dissolved air flotation unit and belt filter press; sludge is hauled away. The discharger added a 20,000 square foot asphalt bed for further sludge drying.

B. Discharge Points and Receiving Waters

As previously noted, the RTP currently discharges 2.2 mgd of secondary treated wastewater and 0.03 mgd tertiary treated wastewater. The treated wastewater is either discharged to one or more of the following Discharge Points:

- 001. Secondary treated, but non-disinfected effluent is discharged to effluent storage ponds No. 16 and 21 prior to discharged to the pipeline to Lucerne Valley¹, where the effluent is used for irrigation of fodder, fiber and seed crops. If there is no demand of water for irrigation, the recycled water is stored in two earth basins for evaporation/percolation disposal in Lucerne Valley.
- 002. Secondary treated and chlorinated effluent is stored in pond No. 14A. Stored water is hauled by tanker truck for delivery to individual recycled water users at construction sites.

BBARWA proposes to convert its existing disposal pond located in the Baldwin Lake into a Wildlife Habitat Area (WHA). This area is surrounded by dike separating it from the remainder of the Baldwin Lake. The top of the dike has a general elevation of 6699 to 6700 feet, about 4 feet above lake bottom. When water in the Baldwin Lake exceeds 6700 feet elevation, the diked area is inundated. Secondary treated and chlorinated effluent is proposed for reuse at the WHA when there is little or no water in Baldwin Lake. During wet months, there would be no treated effluent delivered to the proposed WHA.

- 003. Tertiary treated and UV disinfected wastewater is stored in pond No. 14B. Stored wastewater is trucked or piped to individual recycled water users for landscape irrigation.

The Discharger is authorized to discharge from the following discharge points as set forth below:

Discharge Point	Effluent Description	Discharge Point Latitude	Discharge Point Longitude	Receiving Water	Disposal Site	Recycling Reuse
001	Secondary effluent without disinfection	34 ° 26' 20" N	116 ° 51' 20" W	Lucerne Hydrologic Unit	Storage Ponds in Lucerne Valley	Irrigation in Lucerne Valley
002	Secondary effluent with disinfection	34 ° 16' 10" N	116 ° 49' 00" W	State surface water: a pond in Baldwin Lake; Big Bear Valley groundwater management zone	--	construction and wildlife habitat
003	Tertiary effluent with disinfection	34 ° 16' 10" N	116 ° 49' 00" W	Big Bear Valley groundwater management zone	--	Irrigation

¹ The Colorado River Basin Regional Water Quality Control Board (Region 7) has issued waste discharge requirements for the use of the recycled wastewater in the Lucerne Valley.

The facility location map is shown on Attachment “B”.

The flow diagram for the wastewater treatment process is shown on Attachment “C”.

C. Stormwater Runoff from this Facility

Stormwater runoff from the RTP discharges into a flood zone, which is located at the east side of the plant. The flood zone is about 630 feet long and 60 to 80 feet wide. The flood zone has a holding capacity of about 75,000 gallons. In heavy storm seasons, there is the possibility of overflow from the flooding zone into offsite surface waters.

D. Summary of Existing Requirements and Self-Monitoring Report (SMR) Data

Effluent limitations/Discharge Specifications contained in the current Order for discharges from **Discharge Points 001 and 002, and Monitoring Location 001 and 002**, and representative monitoring data from the term of the previous Order are as follows:

Parameter (units)	Effluent Limitation			Monitoring Data (From April 1, 2002 – To March 31, 2005)		
	Average Monthly	Average Weekly	Maximum Daily	Highest Average Monthly Discharge	Highest Average Weekly Discharge	Highest Daily Discharge
BOD ₅ (mg/l)	30	45	45	16	42	42
Suspended Solids (mg/l)	30	45	45	17	38	38
Electroconductivity	NA	NA	NA	745		1157
pH Daily Average Continuous Recorder (SU)	Daily Minimum 6.5	NA	8.5	7.92		8.20
TDS (mg/l)	550 ⁽¹⁾	NA	NA	436 ⁽¹⁾	481	481
Total Inorganic Nitrogen (mg/l)	10 ⁽²⁾	NA	NA	5.8	26.5	26.5
Chloride(mg/l)	NA	NA	NA	52	60	60
Iron (mg/l)	NA	NA	NA	0.35		0.35
Manganese (mg/l)	NA	NA	NA	0.47		0.47
Sodium (mg/l)	NA	NA	NA	120		120
Sulfate(mg/l)	NA	NA	NA	50	55	55
Total Phosphorus (mg/l)	NA	NA	NA	3.6		3.6
Coliform MPN (Construction Water)	NA	NA	240 ⁽³⁾			>1600
Coliform MPN (Irrigation Water)	NA	NA	240 ⁽³⁾			70
Fluoride (mg/l)	NA	NA	NA	0.89	0.99	0.99
Nitrate-N (mg/l)	NA	NA	NA		10.7	10.7

(1) - TDS shall not exceed 12-month flow weighted average concentration of 550mg/l and shall not exceed

12-month average TDS of water supply by 250mg/l.

- (2) – Discharge shall not exceed 12-month flow weighted average of 10 mg/l total inorganic nitrogen.
- (3) – Discharge shall not exceed 240 MPN for 2 consecutive days.

Parameter (units)	Effluent Limitation			Monitoring Data (From April 1, 2002 – To March 31, 2005)		
	Average Monthly	Average Weekly	Maximum Daily	Highest Average Monthly Discharge	Highest Average Weekly Discharge	Highest Daily Discharge
Antimony (ug/l)	NA	NA	NA	<6.0		
Arsenic (ug/l)	NA	NA	NA	<2.0		
Beryllium (ug/l)	NA	NA	NA	<1.0		
Boron (ug/l)	NA	NA	NA	270		
Cadmium (ug/l)	NA	NA	NA	<1.0		
Chromium-Total Cr (ug/l)	NA	NA	NA	<10		
Lead (ug/l)	NA	NA	NA	<5.0		
Mercury (ug/l)	NA	NA	NA	<1.0		
Nickel (ug/l)	NA	NA	NA	<10		
Selenium (ug/l)	NA	NA	NA	<5.0		
Silver (ug/l)	NA	NA	NA	<10		
Thallium (ug/l)	NA	NA	NA	<1.0		
Zinc (ug/l)	NA	NA	NA	96		
Copper (ug/l)	NA	NA	NA	<50		
VOC's EPA 601/602/603 (ug/l)	NA	NA	NA	ND		

E. Compliance Summary

Data review indicated that wastewater discharges from this treatment plant were in full compliance with waste discharge requirements of Order No. 00-12.

F. Planned Changes

The discharger eliminated two existing surface water discharge outfalls: the East end of Stanfield Marsh Outfall 002 and the Baldwin Lake Stickleback Habitat Outfall 003.

The Discharger proposes to deliver *disinfected secondary treated wastewater* to the discharger's existing wastewater disposal pond in the Baldwin Lake for the purpose of converting the pond into a Wildlife Habitat Area (WHA) when Baldwin Lake is dry or has little water in it.

III. APPLICABLE PLANS, POLICIES, AND REGULATIONS

Based on the U.S. Army Corps of Engineers, the discharger's existing disposal pond in the Baldwin Lake is not considered waters of the U.S. Consequently, this Order is issued as a Waste Discharge and Producer/User Water Recycling Requirements.

The requirements contained in the proposed Order are based on the requirements and authorities described in this section.

A. Legal Authorities

This Order is issued pursuant to Chapter 5.5, Division 7 of the California Water Code (CWC). This Order serves as Waste Discharge Requirements (WDRs) pursuant to Article 4, Chapter 4 of the CWC for discharges that are not subject to regulation under CWA section 402.

B. California Environmental Quality Act (CEQA)

The project involves the update of waste discharge requirements for an existing facility and, as such, is exempt from the California Environmental Quality Act (Public Resources Code, Section 21100 et. seq.) in accordance with Section 15301, Chapter 3, Title 14, California Code of Regulations.

C. State Regulations, Policies, and Plans

1. Water Quality Control Plans.

The Regional Water Board adopted a Water Quality Control Plan for the Santa Ana River Region (hereinafter Basin Plan) that designates beneficial uses, establishes water quality objectives, and contains implementation programs and policies to achieve those objectives for all waters addressed through the plan. More recently, the Basin Plan was amended significantly to incorporate revised boundaries for groundwater subbasins, now termed "management zones", new nitrate-nitrogen and TDS objectives for the new management zones, and new nitrogen and TDS management strategies applicable to both surface and ground waters. This Basin Plan Amendment was adopted by the Regional Board on January 22, 2004. The State Water Resources Control Board and Office of Administrative Law (OAL) approved the Amendment on September 30, 2004 and December 23, 2004, respectively. Beneficial uses applicable to Big Bear Valley Groundwater Management Zone are as follows:

Discharge Point	Receiving Water Name	Beneficial Use(s)
001	Lucerne Hydrologic Unit	Based on Region 7's Basin Plan. 1. Municipal supply 2. Industrial supply 3. Agricultural supply

Discharge Point	Receiving Water Name	Beneficial Use(s)
002	A pond in Baldwin Lake; and Big Bear Valley groundwater management zone	<p><u>Beneficial Uses for Baldwin Lake:</u> <u>Intermittent:</u> 1. Water contact recreation (REC-1), 2. Non-contact water recreation (REC-2), 3. Warm freshwater habitat (WARM), 4. Cold freshwater habitat (COLD), 5. Preservation of biological habitats of special significance (BIOL), 6. Wildlife habitat (WILD), and 7. Rare, threatened or endangered species (RARE). <u>Beneficial Uses for groundwater management zone:</u> <u>Present or Potential:</u> 1. Municipal and domestic supply, and 2. industrial service supply.</p>
003	Big Bear Valley groundwater management zone	<p><u>Beneficial Uses for ground water management zone:</u> <u>Present or potential:</u> Municipal and domestic supply, industrial service supply.</p>

2. **Antidegradation Policy.** State Water Board Resolution No. 68-16 requires that existing water quality is maintained unless degradation is justified based on specific findings. The permitted discharge is consistent with the antidegradation provision of State Water Board Resolution No. 68-16.
3. **Monitoring and Reporting Requirements.** Sections 13267 and 13383 of the CWC authorize the Regional Water Boards to require technical and monitoring reports. The Monitoring and Reporting Program (MRP) establishes monitoring and reporting requirements to implement federal and State requirements. This MRP is provided in Attachment D.

D. Industrial Stormwater Requirements

Pursuant to Section 402(p) of Clean Water Act and Title 40 of the Code of Federal Regulations (CFR) Part 122, 123, and 124, the State Water Resources Control Board adopted general NPDES permits to regulate storm water discharges associated with industrial activities (State Board Order No. 97-03-DWQ) adopted on April 17, 1997. The discharger shall submit notice of intent to be covered under this general permit and develop and implement Storm Water Pollution Prevention Plans to comply with the general NPDES permit.

IV. RATIONALE FOR EFFLUENT LIMITATIONS AND DISCHARGE SPECIFICATIONS

A. Technology-Based Effluent Limitations

1. Scope and Authority

Regulations promulgated in 40 CFR §125.3(a)(1) require technology-based effluent limitations for municipal Dischargers to be placed in waste discharge requirements based on Secondary Treatment Standards or Equivalent to Secondary Treatment Standards.

The Federal Water Pollution Control Act Amendments of 1972 (PL 92-500) established the minimum performance requirements for POTWs [defined in Section 304(d)(1)]. Section 301(b)(1)(B) of that Act requires that such treatment works must, as a minimum, meet effluent limitations based on secondary treatment as defined by the USEPA Administrator.

Based on this statutory requirement, USEPA developed secondary treatment regulations, which are specified in 40 CFR 133. These technology-based regulations apply to all municipal wastewater treatment plants and identify the minimum level of effluent quality attainable by secondary treatment in terms of biochemical oxygen demand (BOD₅), total suspended solids (TSS), and pH.

2. Applicable Technology-Based Effluent Limitations

**Summary of Technology-based Effluent Limitations
 For Secondary Treated Effluent Discharge Points for Discharge Point 001 and 002**

Parameter	Units	Effluent Limitations	
		Average Monthly	Average Weekly
Biochemical Oxygen Demand 5-day @ 20°C	mg/L	30	45
	lbs/day ²	1,223	1,835
Total Suspended Solids	mg/L	30	45
	lbs/day ²	1,223	1,835

**Summary of Technology-based Effluent Limitations
 For Tertiary Treated Effluent Discharge Points for Discharge Point 003**

FOR DISCHARGE SERIAL NO. 003			
Parameter	Units	Effluent Limitations	
		Average Monthly	Average Weekly
Biochemical Oxygen Demand 5-day @ 20°C	mg/L	20	30
	lbs/day ³	167	250
Total Suspended Solids	mg/L	20	30
	lbs/day	167	250

² Based on a design capacity of 4.89 mgd for secondary treatment.

³ Based on tertiary flow of 1.0 mgd.

B. Water Quality-Based Effluent Limitations (WQBELs)

1. Basin Plan states that pH value for groundwater discharge shall not be raised above 9 or depressed below 6 as a result of controllable water quality factors.
2. The dissolved mineral content of the waters of the region as measured by the total dissolved solids test shall not exceed the specific objectives as a result of controllable water quality factors. The TDS and TIN limitations are the same as those in the prior Order No. 00-12 to protect groundwater quality.

C. Reclamation Specifications

Section 13523 of the California Water Code provides that a regional board, after consulting with and receiving the recommendations from the CDHS and any party who has requested in writing to be consulted, and after any necessary hearing, shall prescribe water reclamation requirements for water which is used or proposed to be used as recycled water, if, in the judgment of the Board, such requirements are necessary to protect the public health, safety, or welfare. Section 13523 further provides that such requirements shall include, or be in conformance with, the statewide uniform water recycling criteria established by the CDHS pursuant to California Water Code Section 13521.

This Order implements Title 22 Code of Regulations, Division 4, Environmental Health. The coliform limitations are set up for secondary and tertiary treated wastewater, respectively. Turbidity limits are set up for tertiary treated wastewater for irrigation.

D. Final Effluent Limitations

Effluent limitations – Discharge Points – 001, 002, and 003, beginning June 24, 2005:

1. The discharge of wastewater to Lucerne Valley and recycled water reuse for irrigation, construction, and wildlife habitat shall maintain compliance with the following limitations at Discharge Points 001, 002, and 003, with compliance measured at each individual monitoring location as described in the attached Monitoring and Reporting Program (Attachment D). The wastewater shall at all times be oxidized.

FOR DISCHARGE POINTS NO. 001 AND 002			
Parameter	Units	Discharge Limitations	
		Average Monthly	Average Weekly
Biochemical Oxygen Demand 5-day @ 20°C	mg/L	30	45
	lbs/day ⁴	1,223	1,835
Total Suspended Solids	mg/L	30	45
	lbs/day ⁴	1,223	1,835

⁴ Based on a design capacity of 4.89 mgd for secondary treatment.

FOR DISCHARGE POINT NO. 003			
Parameter	Units	Discharge Limitations	
		Average Monthly	Average Weekly
Biochemical Oxygen Demand 5-day @ 20°C	mg/L	20	30
	lbs/day ⁵	167	250
Total Suspended Solids	mg/L	20	30
	lbs/day ⁵	167	250

2. The pH of the effluent, measured at each monitoring point, shall at all times be within the range of 6 and 9 pH units.
3. Percent Removal: The monthly average biochemical oxygen demand and suspended solids concentrations of the discharge shall not be greater than fifteen percent (15%) of the monthly average influent concentrations.
4. TDS Limitations: for effluent limitations a. and b., below, the lower of the two total dissolved solids limits is the limit. The TDS limitations are applicable for DP Nos. 002 and 003.
 - a. The 12-month average⁶ total dissolved solids concentration shall not exceed 550 mg/l and the 12-month flow weighted average shall not exceed 22,430 lbs/day⁷, and
 - b. The 12-month average total dissolved solids concentration shall not exceed the 12-month average total dissolved solids concentration in the water supply by more than 250 mg/l.
5. Total Inorganic Nitrogen (TIN) Limitations: The 12-month flow-weighted average TIN concentration shall not exceed 10 mg/l.
6. For Discharge from Discharge Point 003: Tertiary treated recycled water shall at all times be a filtered and subsequently disinfected wastewater that meets the following criteria:
 - a. The turbidity of the filtered wastewater does not exceed any of the following:
 - i. for micro-filtration:
 - 1). 0.2 NTU more than 5 percent of the time within a 24-hour period; and
 - 2). 0.5 NTU at any time.
 - ii. for media filtration:
 - 1). 2 NTU more than 5 percent of the time within a 24-hour period; and
 - 2). 5 NTU at any time.

⁵ Based on a design capacity of 1.0 mgd for tertiary treatment.

⁶ See Section VII. D Compliance Determination.

⁷ Calculated from 4.89 mgd x 8.34 x 550 mg/l.

- b. Disinfected tertiary wastewater shall meet the following criteria:
 - i. The median concentration of total coliform bacteria measured in the disinfected effluent shall not exceed a most probable number (MPN) of 2.2 per 100 milliliters utilizing the bacteriological results of the last seven days for which analyses have been completed.
 - ii. The number of total coliform bacteria shall not exceed an MPN of 23 per 100 milliliters in more than one sample in any 30-day period.
 - iii. No sample shall exceed an MPN of 240 total coliform bacteria per 100 milliliters.
7. For Discharge Point 002: wastewater shall at all times be an oxidized and subsequently disinfected wastewater that meets the following criteria:
 - a. The median concentration of total coliform bacteria in the disinfected effluent shall not exceed an MPN of 23 per 100 milliliters utilizing the bacteriological results of the last even days for which analyses have been completed⁸.
 - b. The number of total coliform bacteria shall not exceed an MPN of 240 per 100 milliliters in more than one sample in any 30-day period.

V. RATIONALE FOR RECEIVING WATER LIMITATIONS

A. Surface Water

Discharge to Discharge Point 002 to the pond (WHA) in the Baldwin Lake takes place in the dry season when the pond is dry or contains no natural flow. Therefore, no surface water limit is needed.

B. Groundwater

The soils in the on-site storage/holding ponds, and the Wildlife Habitat Area in the Baldwin Lake have low percolation rates. However, there is a potential for percolation for recycled water in the irrigation and construction site areas. Therefore, this order established TDS limits and total inorganic nitrogen limit to protect groundwater quality.

VI. RATIONALE FOR MONITORING AND REPORTING REQUIREMENTS

Sections 13267 and 13383 of the California Water Code authorize the Water Boards to require technical and monitoring reports. The Monitoring and Reporting Program, Attachment D of this Order, establishes monitoring and reporting requirements to implement federal and state requirements. The following provides the rationale for the monitoring and reporting requirements contained in the Monitoring and Reporting Program for this facility.

⁸ Title 22, 60301.220.

A. Influent Monitoring

To monitor influent flow to protect operation of the treatment plant and to identify any pollutant into the plant. BOD/TSS monitoring is to measure the BOD/TSS removal rate.

B. Effluent Monitoring

To determine compliance with effluent limitations, all parameters established in this Order must be monitored and tested. Other parameters, such as priority pollutants and minerals are also required to be monitored based on Basin Plan.

VII. PUBLIC PARTICIPATION

The California Regional Water Quality Control Board, Santa Ana Region (Regional Water Board) is considering the issuance of waste discharge requirements (WDRs) for BBARWA's Regional Treatment Plant. As a step in the WDR adoption process, the Regional Water Board staff has developed tentative WDRs. The Regional Water Board encourages public participation in the WDR adoption process.

A. Notification of Interested Parties

The Regional Water Board has notified the Discharger and interested agencies and persons of its intent to prescribe waste discharge requirements for the discharge and has provided them with an opportunity to submit their written comments and recommendations. Notification was provided through the posting of Notice of Public Hearing at Big Bear Lake City Hall on May 25, 2005 and posting of Notice of Public Hearing at the Regional Board website.

B. Written Comments

The staff determinations are tentative. Interested persons are invited to submit written comments concerning these tentative WDRs. Comments should be submitted either in person or by mail to the Executive Office at the Regional Water Board at the address above on the cover page of this Order.

To be fully responded to by staff and considered by the Regional Water Board, written comments should be received at the Regional Water Board offices by 5:00 p.m. on **June 6, 2005**.

C. Public Hearing

The Regional Water Board will hold a public hearing on the tentative WDRs during its regular Board meeting on the following date and time and at the following location:

Date: **June 24, 2005**
Time: **9:00 am**
Location: **City Council Of Loma Linda
25541 Barton Road
City Of Loma Linda**

Interested persons are invited to attend. At the public hearing, the Regional Water Board will hear testimony, if any, pertinent to the discharge and WDRs. Oral testimony will be heard; however, for accuracy of the record, important testimony should be in writing.

Please be aware that dates and venues may change. Our web address is <http://www.waterboards.ca.gov/santaana> where you can access the current agenda for changes in dates and locations.

D. Waste Discharge Requirements Petitions

Any aggrieved person may petition the State Water Resources Control Board to review the decision of the Regional Water Board regarding the final WDRs. The petition must be submitted within 30 days of the Regional Water Board's action to the following address:

State Water Resources Control Board
Office of Chief Counsel
P.O. Box 100, 1001 I Street
Sacramento, CA 95812-0100

E. Information and Copying

The Report of Waste Discharge (RWD), related documents, tentative effluent limitations and special provisions, comments received, and other information are on file and may be inspected at the address above at any time between 8:30 a.m. and 4:45 p.m., Monday through Friday. Copying of documents may be arranged through the Regional Water Board by calling (951) 782-4130.

F. Register of Interested Persons

Any person interested in being placed on the mailing list for information regarding the WDRs should contact the Regional Water Board, reference this facility, and provide a name, address, and phone number.

G. Additional Information

Requests for additional information or questions regarding this order should be directed to Jane Qiu at (951) 320-2008 or jqiu@waterboards.ca.gov.

Appendix B. Recycled Water Overview

RECYCLED WATER POLICY

The SWRCB adopted the Recycled Water Policy (RW Policy) in February 2009, and subsequently amended it in January 2013. The purpose of the policy was to provide the RWQCBs, proponents of recycled water projects, and the public the appropriate criteria to be used in issuing permits for recycled water projects. The RW Policy established more uniform requirements throughout the State and streamlined the permitting process for the vast majority of recycled water projects. Key components of the RW Policy are summarized below.

Component	Description
Recycled Water Targets	200,000 AFY by 2020 300,000 AFY by 2030
Permitting Process	Recycled water irrigation projects permitted within 120 days (except for unusual requirements) without groundwater monitoring component.
Salt and Nutrient Management Plans	Required for all groundwater basins. Includes identification of salt and nutrient sources, assimilative capacity evaluation, load estimates, fate and transport analysis and implementation measures. Includes anti-degradation analysis for recycled water projects.
Landscape Irrigation Project Requirements	Requirements related to controlling water runoff, salt, and soil nutrients. Provisions for streamlined permitting for projects that meet specific criteria related to application rates, oversight, and controls.
RWQCB Groundwater Requirements	Allows RWQCB to impose more stringent requirements for groundwater recharge projects to address site specific conditions.
Anti-degradation Analysis	Requirements for anti-degradation analysis for groundwater recharge and landscape irrigation projects based on the amount of assimilative capacity use by the project.
CEC Monitoring	Requirements for Constituent of Emerging Concern (CEC) monitoring for groundwater recharge projects.

One of the key components of the RW Policy is the requirement for a Salt and Nutrient Management Plan (SNMP). The RW Policy states that SNMPS should be developed to facilitate basin-wide management of salts and nutrients from all sources in a manner that optimizes recycled water use while ensuring protection of groundwater supply and beneficial uses, agricultural beneficial uses, and human health. The Santa Ana Region Basin Plan includes an SNMP, as described later in this Appendix.

SANTA ANA REGION BASIN PLAN

The Basin Plan establishes water quality standards for the ground and surface waters of the region and includes an implementation plan describing the actions by the Regional Board and others that are necessary to achieve and maintain the water quality standards. The Basin Plan provides general narrative objectives for each water body type and specific numeric objectives for total dissolved solids (TDS), hardness, sodium, chloride, total inorganic nitrogen (TIN), sulfate, and chemical oxygen demand (COD). Most Groundwater Management Zones have numeric objectives for only TDS and TIN.

Some waters in the Region have assimilative capacity for additions of TDS and/or nitrogen. If the current quality of a management zone is the same as or poorer than the specified water quality objectives, then that management zone does not have assimilative capacity. If the current quality is better than the specified water quality objectives, then that management zone has assimilative capacity. The difference between the objectives and current quality is the amount of assimilative capacity available. The amount of assimilative capacity, if any, varies depending on the individual characteristics of the waterbody in question and must be reevaluated over time. As part of the agreement to adopt the 2004 Basin Plan Amendment, the affected parties agreed to recompute ambient water quality for the individual management zones every three years and formed the BMPTF to oversee this effort, among other tasks. Since adoption of the 2004 Basin Plan amendment and per Basin Plan requirements, ambient quality and assimilative capacity findings have been, and will continue to be, updated every three years. The current findings are presented in the Recomputation of Ambient Water Quality in the Santa Ana Watershed for the Period 1993 to 2012 (18). However, this process does not currently include assessment of the Big Bear Valley Groundwater Management Zone.

If a discharger proposes to discharge wastes that are at or below the current ambient TDS and/or nitrogen water quality, then the discharge will not be expected to result in the lowering of water quality, and no antidegradation analysis will be required because TDS and nitrogen objectives are expected to be met. If there is assimilative capacity in the receiving waters for TDS, nitrogen or other constituents, a waste discharge may be of poorer quality than the objectives for those constituents for the receiving waters, as long as the discharge does not cause violation of the objectives, and provided that antidegradation requirements are met. However, if there is no assimilative capacity in the receiving waters, the numerical limits in the discharge requirements cannot exceed the receiving water objectives or the degradation process would be accelerated.

Discharges to waters without assimilative capacity for TDS and/or nitrogen must be held to the objectives of the affected receiving waters. In some cases, compliance with management zone TDS objectives for discharges to waters without assimilative capacity may be difficult to achieve. Poor quality water supplies or the need to add certain salts during the treatment process to achieve compliance with other discharge limitations (e.g., addition of ferric chloride) could render compliance with strict TDS limits very difficult. The Regional Board addresses such situations by providing dischargers with the opportunity to participate in TDS offset programs, such as the use of desalters, in lieu of compliance with numerical TDS limits. These offset provisions are incorporated into waste discharge requirements. Provided that the discharger takes all reasonable steps to improve the quality of the waters influent to the treatment facility (such as through source control or improved water supplies), and provided that chemical additions are minimized, the discharger can proceed with an acceptable program to offset the effects of TDS discharges in excess of the permit limits.

The Basin Plan provides for alternative pathways to obtain approval for discharges that do not meet the conditions described previously.

The Basin Plan provides that a discharger may conduct analyses to demonstrate that discharges at levels higher than the objectives would not cause or contribute to the violation of the established objectives. If the Regional Board approves this demonstration, then the discharger would be regulated accordingly.

Another alternative that dischargers might pursue is revision of the TDS or nitrogen objectives, through the Basin Plan amendment process. Consideration of less stringent objectives would necessitate comprehensive antidegradation review, including the demonstrations that beneficial uses would be protected and that water quality consistent with maximum benefit to the people of the State would be maintained. Several dischargers, including Yucaipa Valley Water District in the Yucaipa Basin, have pursued this “maximum benefit objective” approach, leading to the inclusion of “maximum benefit” objectives and implementation strategies in the Basin Plan. Discharges to areas where the “maximum benefit” objectives apply will be regulated in conformance with these implementation strategies. Any assimilative capacity created by the maximum benefit programs will be allocated to the parties responsible for implementing them.

Anti-Degradation Policy

The RW Policy addresses implementation of the Anti-degradation Policy, as it relates to recycled water projects. In general, the Anti-degradation Policy requires protection of groundwaters and surface waters having quality that is better than that established in effective policies. The policy states that high quality waters shall be maintained unless any change will be consistent with the maximum benefit to the people of the State, will not unreasonably affect present and anticipated beneficial uses and will not result in water quality less than that prescribed in the policies.

Beneficial Uses

The Federal Clean Water Act (CWA) requires states to establish water quality standards for surface waters, consisting of use types and water quality criteria. In California, beneficial uses are established for all waters of the state, including both surface water and groundwater, to specify how that water can be used for the benefit of the public and/or wildlife. The State applies WQOs to protect the beneficial use attributed to the water of the state. Of the beneficial uses recognized in the Santa Ana Region, those that apply to waterbodies in the Big Bear Valley are included in the following table.

Beneficial Use Type	Beneficial Use
Municipal and Domestic Supply (MUN)	Community, military, municipal or individual water supply systems. These uses may include, but are not limited to, drinking water supply.
Agricultural Supply (AGR)	Farming, horticulture or ranching. These uses may include, but are not limited to, irrigation, stock watering, and support of vegetation for range grazing.
Industrial Process Supply (PROC)	Industrial activities that depend primarily on water quality. These uses may include, but are not limited to, process water supply and all uses of water related to product manufacture or food preparation.
Groundwater Recharge (GWR)	Natural or artificial recharge of groundwater for purposes that may include, but are not limited to, future extraction, maintaining water quality or halting saltwater intrusion into freshwater aquifers.
Water Contact Recreation (REC 1) ¹	Recreational activities involving body contact with water where ingestion of water is reasonably possible. These uses may include, but are not limited to, swimming, wading, water-skiing, skin and scuba diving, surfing, whitewater activities, fishing and use of natural hot springs.
Non-contact Water Recreation (REC 2) ¹	Recreational activities involving proximity to water, but not normally involving body contact with water where ingestion of water would be reasonably possible. These uses may include, but are not limited to, picnicking, sunbathing, hiking, beachcombing, camping, boating, tidepool and marine life study, hunting, sightseeing and aesthetic enjoyment in conjunction with the above activities.
Warm Freshwater Habitat (WARM)	Support of warmwater ecosystems that may include, but are not limited to, preservation and enhancement of aquatic habitats, vegetation, fish and wildlife, including invertebrates.
Cold Freshwater Habitat (COLD)	Support of coldwater ecosystems that may include, but are not limited to, preservations and enhancement of aquatic habitats, vegetation, fish and wildlife, including invertebrates.
Preservation of Biological Habitats of Special Significance (BIOL)	Support of designated areas or habitats, including, but not limited to, established refuges, parks, sanctuaries, ecological reserves or preserves, and Areas of Special Biological Significance (ASBS), where the preservation and enhancement of natural resources requires special protection.
Wildlife Habitat (WILD)	Support of wildlife habitats that may include, but are not limited to, the preservation and enhancement of vegetation and prey species used by waterfowl and other wildlife.
Rare, Threatened or Endangered Species (RARE)	Support the habitats of necessary for the survival and successful maintenance of plant or animal species designated under state or federal law as rare, threatened or endangered.
Spawning, Reproduction and Development (SPWN)	Support of high quality aquatic habitats necessary for reproduction and early development of fish and wildlife.

Notes:

1. The REC 1 and REC 2 beneficial use of designations assigned to surface waterbodies in this Region should not be construed as encouraging recreational activities. In some cases, such as Lake Matthews and certain reaches of the Santa Ana River, access to the waterbodies is prohibited because of potentially hazardous conditions and/or because of the need to protect other uses, such as municipal supply or sensitive wildlife habitat. Where REC 1 or REC 2 is indicated as a beneficial use in Table 3-1, the designations are intended to indicate that the uses exist or that the water quality of the waterbody could support recreational uses.

RESTRICTED AND UNRESTRICTED IRRIGATION REGULATIONS

The following section summarizes California Code of Regulations (CCR) Title 22 regulations as well as Santa Ana Basin Plan objectives which will establish regulatory criteria for irrigation projects using recycled water.

CCR – Title 22

Title 22, established and administered by DDW, defines four types of recycled water uses based on the treatment process used and water quality produced. These four types of recycled water are described as follows and as summarized in Appendix B.

- Undisinfected secondary recycled water - Oxidized wastewater that has not been disinfected.
- Disinfected secondary-23 recycled water – Recycled water that has been oxidized and disinfected so that the median concentration of total coliform bacteria in the disinfected effluent does not exceed a Most Probable Number (MPN) of 23 per 100 milliliters utilizing the bacteriological results of the last seven days for which analyses have been completed, and the number of total coliform bacteria does not exceed an MPN of 240 per 100 milliliters in more than one sample in any 30-day period.
- Disinfected secondary-2.2 recycled water – Recycled water that has been oxidized and disinfected so that the median concentration of total coliform bacteria in the disinfected effluent does not exceed a MPN of 2.2 per 100 milliliters utilizing the bacteriological results of the last seven days for which analyses have been completed, and the number of total coliform bacteria does not exceed an MPN of 23 per 100 milliliters in more than one sample in any 30-day period.
- Disinfected tertiary recycled water - Filtered and subsequently disinfected wastewater that meets the following criteria:
 - (a) The filtered wastewater has been disinfected by either:
 1. A chlorine disinfection process following filtration that provides a contact time (CT) (the product of total chlorine residual and modal contact time measured at the same point) value of not less than 450 milligram-minutes per liter at all times with a modal contact time of at least 90 minutes, based on peak dry weather design flow; or
 2. A disinfection process that, when combined with the filtration process, has been demonstrated to inactivate and/or remove 99.999 percent of the plaque forming units of F-specific bacteriophage MS2, or polio virus in the wastewater. A virus that is at least as resistant to disinfection as polio virus may be used for purposes of the demonstration.
 - (b) The median concentration of total coliform bacteria measured in the disinfected effluent does not exceed an MPN of 2.2 per 100 milliliters utilizing the bacteriological results of the last seven days for which analyses have been completed and the number of total coliform bacteria does not exceed an MPN of 23 per 100 milliliters in more than one sample in any 30-day period. No sample shall exceed an MPN of 240 total coliform bacteria per 100 milliliters

Treatment Level	Approved Uses	Total Coliform (median)
Undisinfected Secondary	Fodder, Fiber and Seed Crops	N/A
Disinfected Secondary 23	Pasture for Milking Animals Landscape Irrigation ¹ Landscape Impoundment Soil Compaction, Dust Control on Roads and Streets	23/100 mL
Disinfected Secondary 2.2	Surface Irrigation of Food Crops Restricted Recreational Impoundment Surface Irrigation of Orchards, Vineyards	2.2/100 mL
Disinfected Tertiary	Spray Irrigation of Food Crops Landscape Irrigation ² Unrestricted Recreational Impoundment	2.2/100 mL
Notes:		
1. Includes restricted access golf courses, cemeteries, freeway landscapes, and landscapes with similar public access.		
2. Includes unrestricted access golf courses, parks, playgrounds, schoolyards, and other landscaped areas with similar access.		

Disinfected tertiary recycled water can also be used for industrial purposes. These uses are summarized in Appendix B.

Industrial Use	Approved Uses
Supply for Cooling and Air Conditioning	Industrial or commercial cooling or air-conditioning involving cooling tower, evaporative condenser, or spraying that creates mist. Industrial or commercial cooling or air-conditioning not involving cooling tower, evaporative condenser, or spraying that creates mist
Other Allowed Uses	Flushing toilets and urinals Priming drain traps Structural fire fighting Non-structural fire fighting Industrial process water that will not come into contact with workers Industrial process water that may contact workers Industrial boiler feed water Decorative fountains Commercial laundries Consolidation of backfill material around potable water pipelines Dust control on roads and streets Mixing concrete Flushing sanitary sewers Soil compaction Artificial snow making for commercial outdoor use Cleaning roads, sidewalks, and outdoor work areas Commercial car washes, not heating the water, excluding the general public from washing processes

Impounded Recycled Water Regulations – Fish Hatcheries

Recycled water to be used in a fish hatchery may be categorized as impounded water under Title 22, which specifies the following regulations for impounded water:

- Recycled water used as a source of supply for restricted recreational impoundments and for any publicly accessible impoundments at fish hatcheries shall be at least disinfected secondary-2.2 recycled water.

However, there are no known fish hatcheries in California that are using recycled water to raise fish for human consumption. Additional research would be needed to verify whether this is a viable use of recycled water that there are likely other water quality, environmental, and public health considerations that will be controlling and will require a higher level of treatment.

Recycled Water Operational and On-site Requirements

There are operational and on-site requirements for different beneficial uses per Title 22. The Title 22, Recycled Water Ordinance, and recycled water rules and regulations requirements are discussed in the following sections

Use Area Requirements

Title 22 includes two main requirements that will need to be considered during the design phase. Per Title 22, no irrigation with disinfected tertiary recycled water shall take place within 50 ft of any domestic water supply well unless the well meets certain criteria including:

- An annular seal
- Well housing to prevent recycled water spray from contacting the wellhead

Also per Title 22, no impoundment of disinfected tertiary recycled water shall occur within 100 ft of any domestic water supply well.

Recycled Water Ordinance

The purpose of a Recycled Water Ordinance is to establish a water recycling policy and criteria for its use within the agency's jurisdiction. In general, a Recycled Water Ordinance will accomplish the following:

- Establish Administrative Authority
- Establish approved uses of recycled water
- Define areas of potential eligibility for recycled water service
- Specify mandatory and voluntary uses of recycled water, depending on user classifications
- Require installation of transmission and distribution infrastructure
- Provide enforcement and severability clauses

Recycled Water Rules and Regulations

The Rules and Regulations govern the design, construction, and use of both the distribution system, to be operated by BBARWA and/or Project Team and on-site recycled water systems to be operated by the users. In general, the Rules and Regulations document will include the following elements:

- Responsibilities for the Project Team and Users
- Requirements for the design, installation, and inspection of the distribution systems and on-site recycled water systems
- Application procedures and BBARWA approval process
- Operation, Maintenance, and Management responsibilities for Users and the Project Team
- Cross connection control test procedures

- Employee training requirements
- Prohibitions and Enforcement

INDIRECT POTABLE REUSE VIA GROUNDWATER RECHARGE

The following section summarizes CCR Title 22 regulations for IPR projects through groundwater recharge. It also addresses components of the Santa Ana Basin Plan, Anti-Degradation policy addressed in the RW Policy, and the Sustainable Groundwater Management Act (SGMA) that may impact a groundwater recharge recycling.

CCR – Title 22

In response to current drought conditions in California, Senate Bill 104 was signed into law in March 2014. This bill included a requirement for DDW to adopt emergency regulations for groundwater replenishment using recycled water by June 30, 2014. The current Groundwater Recharge Regulations were adopted as an emergency regulation and became effective June 18, 2014. These regulations have been incorporated in the CCR, Title 22.

The Groundwater Recharge Regulations define a Groundwater Replenishment Reuse Project (GRRP) as a project using recycled municipal wastewater for the purpose of replenishment of groundwater that is designated a source of water supply in a Water Quality Control Plan, or which has been identified as a GRRP by the RWQCB. GRRPs can employ surface spreading basins or subsurface injection methods. The Groundwater Recharge Regulations address the following types of recharge:

- Surface spreading without full advanced treatment (FAT)
- Subsurface application (FAT required for the entire flow)
- Surface spreading with FAT

CCR Title 22, Section 60320.201 defines FAT as “the treatment of an oxidized wastewater . . . using a reverse osmosis (RO) and an oxidation treatment process (AOP)” According to the Groundwater Recharge Regulations, FAT is the required treatment process for groundwater augmentation using direct injection, unless an alternative treatment has been demonstrated to DDW as providing equal or better protection of public health and has received written approval from DDW.

Both surface spreading and subsurface application are considered to be indirect potable reuse (IPR). The specific regulations for these different methods of groundwater recharge are different. However, the regulations generally address the following elements:

- Source control
- Emergency response plan
- Pathogen control
- Nitrogen control
- Regulated chemicals control
- Initial recycled water contribution (RWC)
- Increased RWC
- Advanced treatment criteria
- Application of advanced treatment
- Soil aquifer treatment (SAT) performance (surface application)
- Response retention time

Several of the key regulatory requirements for groundwater recharge are summarized in Appendix B. Additional descriptions of pathogen controls, retention time and the RWC follows.

Pathogen controls include specific provisions for log reduction of microorganisms and treatment process requirements. The treatment process used to treat recharge water for a GRRP must provide treatment that achieves at least 12-log enteric virus reduction, 10-log *Giardia* cyst reduction, and 10-log *Cryptosporidium* oocyst reduction from raw sewage to usable groundwater. The treatment train shall consist of at least three separate treatment processes. For each pathogen (i.e., virus, *Giardia* cyst, or *Cryptosporidium* oocyst), a separate treatment process may be credited with no more than 6-log reduction, with at least three processes each being credited with no less than 1.0-log reduction.

The Groundwater Recharge Regulations require a minimum “response retention time” or minimum groundwater travel time of two months between the point of surface application or injection, and the point of extraction. Groundwater travel time can be estimated by various methods, including intrinsic tracer studies, numerical modeling, or analytical modeling. Depending on the method used, the “response time credit” is discounted by different factors. The more rigorous the estimating approach, the more advantageous the discounting factor.

The Groundwater Recharge Regulations require that the ratio of purified recycled water to the total injected water, known as the RWC, be determined periodically, and that it is not to exceed a value determined during the DDW’s review of the engineering report and the results of public hearings. Only water that is either a DDW-approved drinking water, or meets certain quality criteria (e.g., does not exceed primary or secondary maximum contaminant levels (MCLs) or notification levels) may be used as diluent water. The Groundwater Recharge Regulations allow the RWC to be 100% if it can be demonstrated that sufficient protections are afforded within the total project design and proposed operational scheme.

Element	Surface Recharge	Subsurface Recharge
Required Treatment Level	Disinfected tertiary	100% RO and AOP treatment for the entire waste stream
Retention time⁽¹⁾	Minimum 2 months (however additional treatment may be required for < 6 months)	Minimum 2 months
Recycled Water Max Initial Contribution (RWC_{max})	Up to 20% disinfected tertiary Up to 100% with RO and AOP	Up to 100% with RO and AOP
Total Nitrogen	Average <10 mg/L	Average <10 mg/L
Total Organic Carbon	Mound < 0.5 mg/L ÷ RWC	< 0.5 mg/L
Dilution water compliance calculation	Based on 120-month running average	Based on 120-month running average
Pathogen Reduction²	12-log enteric virus reduction, 10-log Giardia cyst reduction, 10-log Cryptosporidium oocyst	
Notes: 1. Must be verified by a tracer study. An 8-month minimum is required for planning level estimates based on numerical modeling. 2. Minimum of 3 barriers and each barrier must achieve a minimum of 1-log reduction. No barrier can achieve more than 6-log.		

SURFACE WATER AUGMENTATION AND DIRECT POTABLE REUSE

The SB 918 approved on September 30th, 2010 and subsequent SB 322 approved on October 8th, 2014 require an advisory group and expert panel to investigate and report to Legislature on the feasibility of developing uniform water recycling criteria for DPR and IPR through surface water augmentation. The final expert panel report on the feasibility of DPR is due to legislature on December 31st, 2016.

Uniform criteria for DPR and IPR through surface water augmentation are not currently in place. As a minimum recycled water feasibility studies should aim to meet the requirements established by groundwater recharge regulations.

Summary of Permit Requirements

Each type of beneficial reuse or disposal alternative will follow a defined regulatory process to obtain required permits for waste discharge and recycled water reuse. The Waste Discharge Requirements (WDRs) Program regulates point discharges to land or groundwater. Recycled water irrigation and recycled water use are administered under the WRDs Program. The project proponent must file a complete Report of Waste Discharge (ROWD) with the Santa Ana Central to obtain a new or revised WDR. This report must include detailed information about the wastewater treatment facility, description of the discharge type, quality, quantity, interval, and method of discharge, and location of discharge points. The ROWD is reviewed by both the State Division of Drinking Water (DDW) and the RWQCB. A streamlined permitting process is established for irrigation projects. The RW Policy identifies further criteria to provide direction for the SWRCB and RWQCB to permit IPR groundwater recharge and recovery projects. For projects that discharge to the Santa Ana River, a new or revised NPDES permit will be required. Additionally, IPR through surface water augmentation involves a more complicated regulatory process to obtain permitting, including advisory panel review, pilot testing, and tracer studies, as these regulations have not been fully developed. Appendix B provides an overview of the permitting procedure for the various types of recycled water projects.

SUSTAINABLE GROUNDWATER MANAGEMENT ACT (SGMA)

DWR has developed a Strategic Plan for the SGMA program to protect groundwater basins that provide more than half of California's water use in dry years. Under the new groundwater management legislation, DWR released an initial basin prioritization list on January 31, 2015. The Basin prioritization ranking considers the percent of total groundwater use in the basin as well as the overlying population. The Bear Valley basin is ranked as a medium priority basin.

A local agency, combination of local agencies, or county may establish a Groundwater Sustainability Agency (GSA). It is the GSA's responsibility to develop and implement a GSP that considers all beneficial uses and users of groundwater in the basin. DWR will develop regulations for evaluating GSPs and alternatives to GSPs by June 1, 2016 and GSAs must be formed by June 30, 2017. GSAs must develop GSPs with measurable objectives and interim milestones that ensure basin sustainability. A basin may be managed by a single GSP or multiple coordinated GSPs. By January 21, 2022, high and medium priority basins not in critical overdraft must be managed under a GSP.

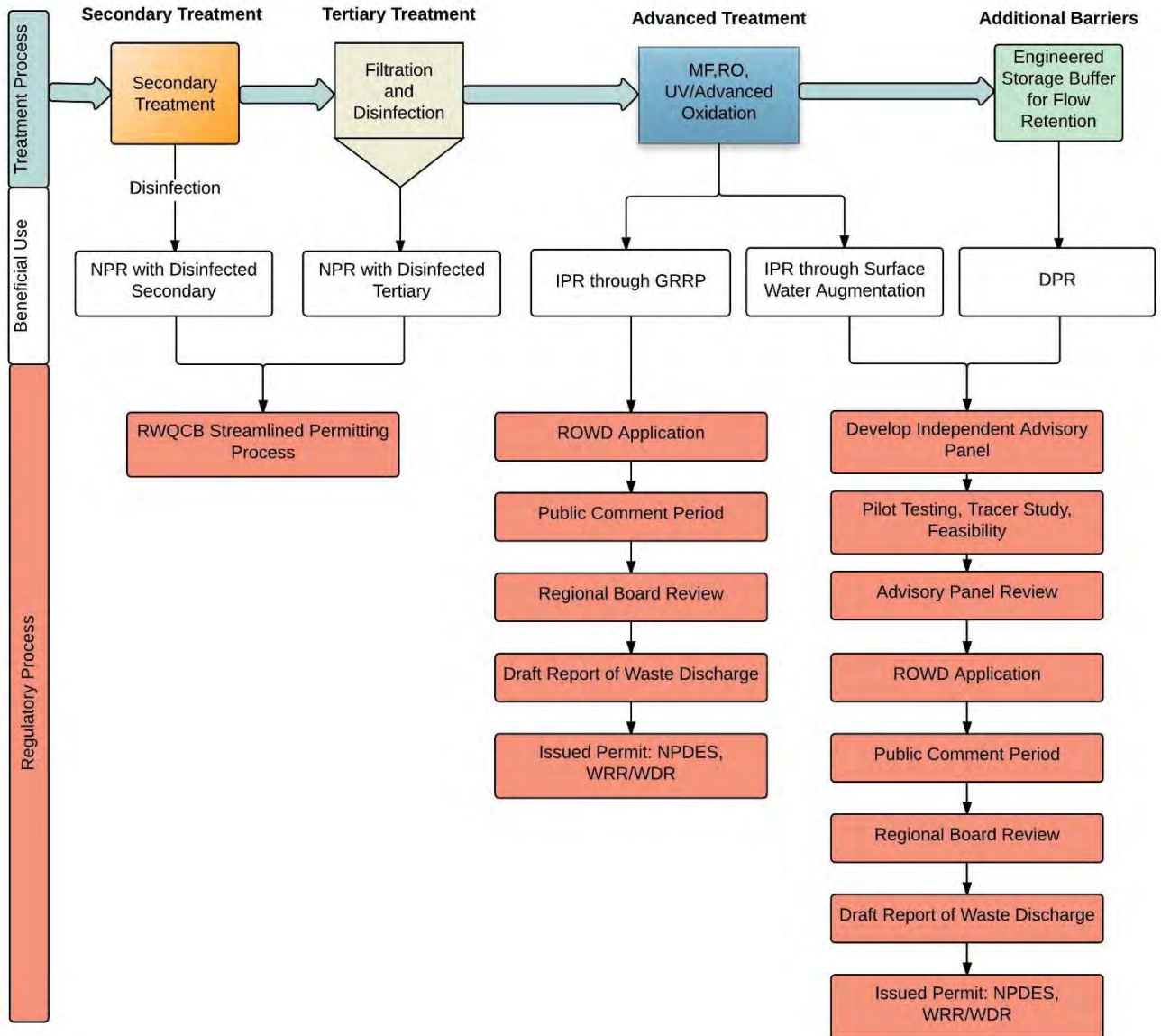

Appendix C. Water Reuse Timeline and References



A Timeline of the Evolving Wastewater Management In the Big Bear Valley

September 24, 2003

By

Steven C. Schindler, General Manager
Big Bear Area Regional Wastewater Agency

Preface

The Big Bear Valley has seen an *evolution of wastewater management* through:

- the developing Big Bear area organizations involved since 1935;
- developing strategies and plans in treatment and disposal of wastewater;
- developing beneficial uses of treated wastewater, both secondary and tertiary;
- more involvement of the regulatory agencies, permitting these beneficial uses;
- developing concepts for advanced, membrane and ultraviolet-based wastewater treatment;
- pilot testing of artificial surface recharge and through-the-earth percolation to aquifers;
- continuing to support interactive, open-door, education-information communications.

So much has transpired since 1935. BBARWA's open-door, education-information communication activities, such as the Water Summit meetings with the public community invited, leads to an underlying question of, "how did we get to where we are today?" This timeline may help answer that question by illuminating Big Bear Valley's legacy in wastewater treatment.

Reading a chronologically written summary of the *evolution of wastewater management* could replace counting sheep. Even transforming it into an outline doesn't quite do it. So, I thought a *timeline format*, which we are now using successfully in ongoing BBARWA projects, would work.

Laying out events from 1935 to 2003 may have resulted in a few omissions and errors. If any are found, I would appreciate any inputs. I plan to periodically expand this timeline portrayal and will be glad to review and incorporate provided inputs.

Steve Schindler

Timeline Summary of Wastewater Management in the Big Bear Area (Page 1 of 2)

This timeline provides a brief pictorial summary of sequential events beginning in 1935 regarding wastewater management in the Big Bear Area.

Steven C. Schindler, 9-12-03
General Manager, BBARWA

1900's

1900's

2000's

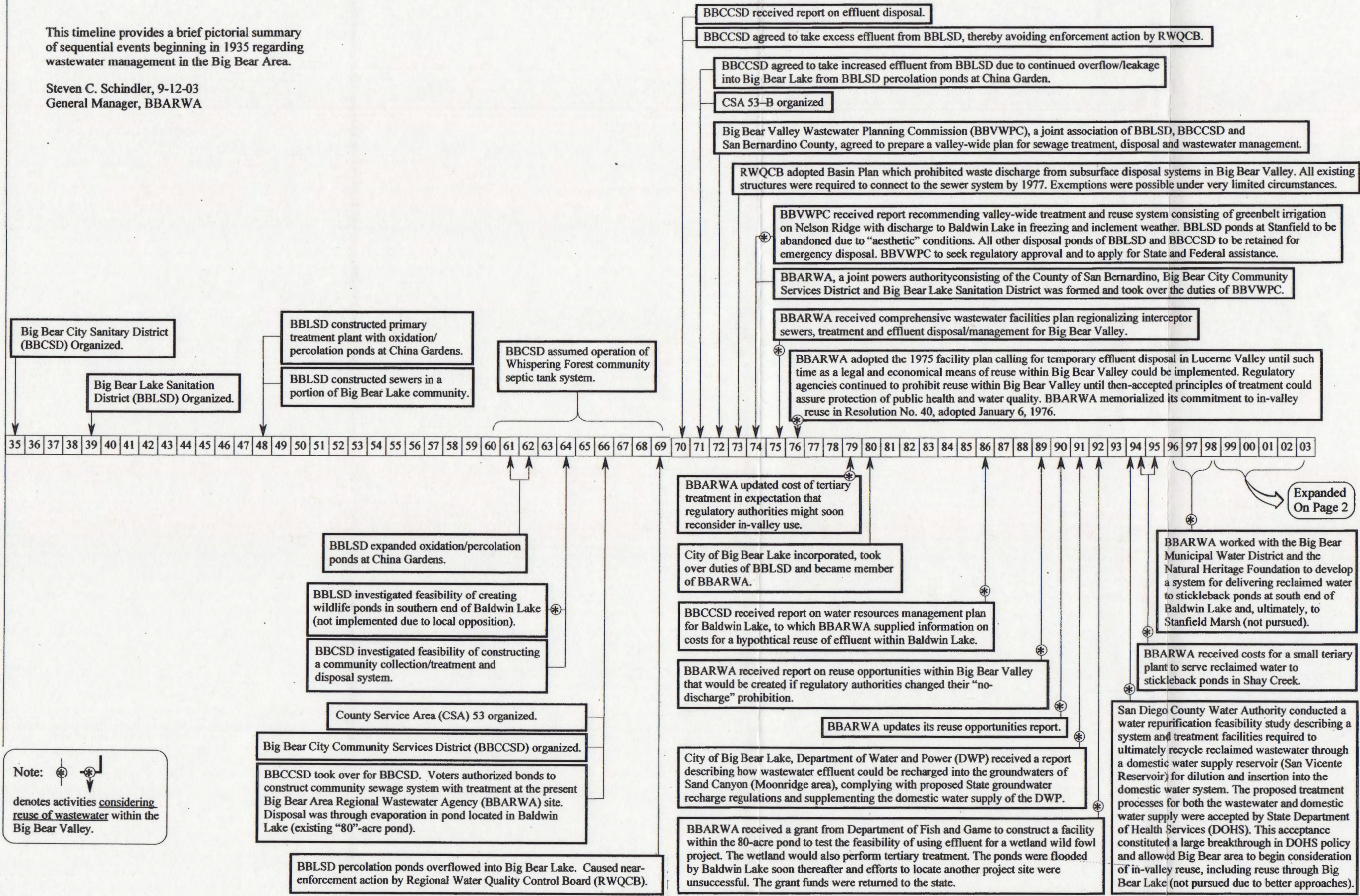

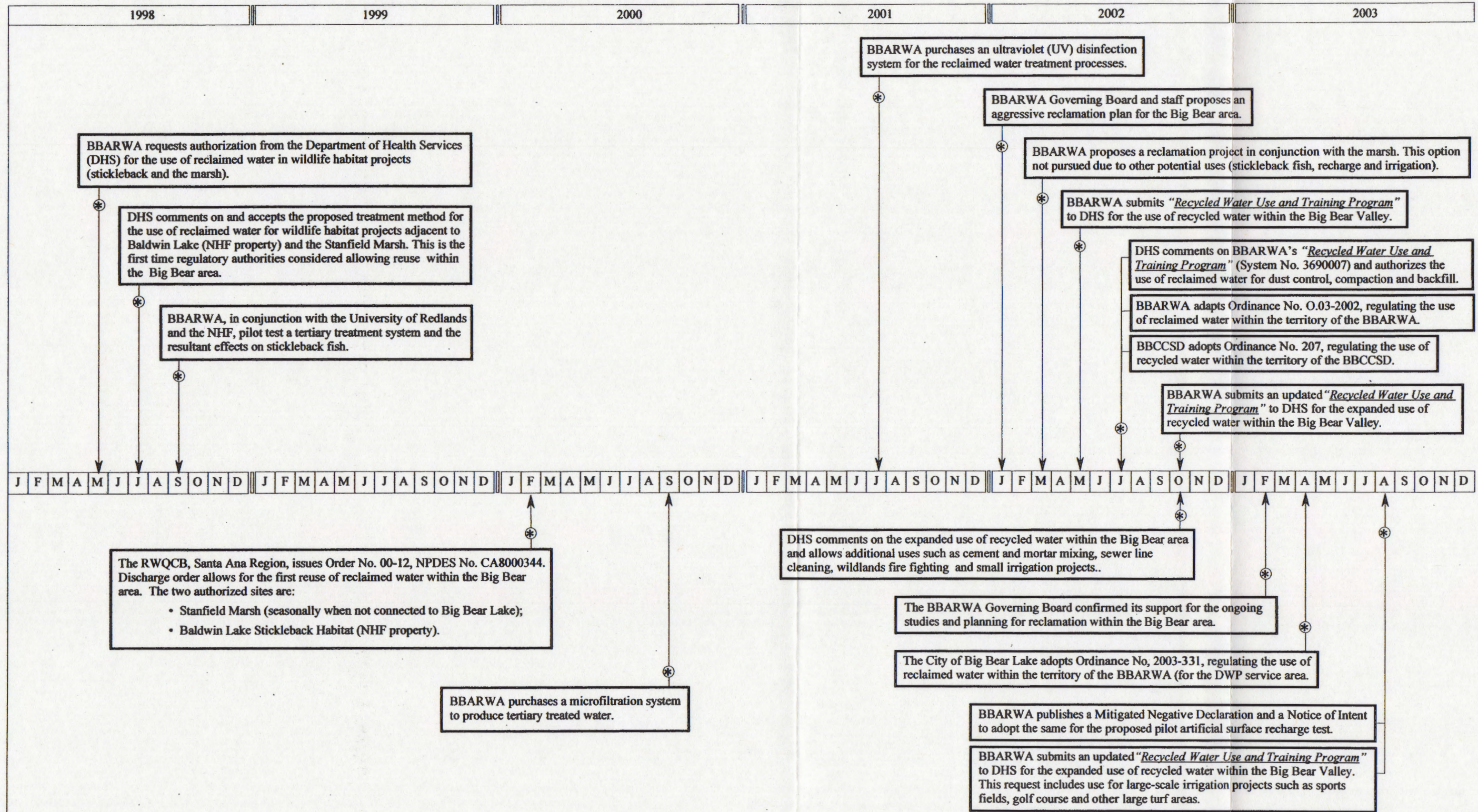

Note: * denotes activities considering reuse of wastewater within the Big Bear Valley.

Expanded On Page 2



NK 9-22-03

Note:  
denotes activities considering reuse of wastewater within the Big Bear Valley.

PLEASE NOTE: The Big Bear Area Regional Wastewater Agency (BBARWA) maintains most of the below documents at their offices. The public is invited to review any of these documents at BBARWA's office or the office that the document is located. BBARWA may charge for the cost of documents if copies are requested.

The location of the document is specified by the red lettering at the end.

Big Bear Area Regional Wastewater Agency = (BBARWA)
121 Palomino Drive, Big Bear City, CA 92314

City of Big Bear Lake, Department of Water and Power = (DWP)
41972 Garstin Drive, Big Bear Lake, CA 92315

Big Bear City Community Services District = (CSD)
139 E. Big Bear Blvd., Big Bear City, CA 92314

Partial list of references and work products are listed below:

Wastewater Facilities Plan, Big Bear Area, Collection, Treatment, Disposal, and Reclamation for the BBARWA. Big Bear Area Regional Wastewater Agency. 1975 (BBARWA)

Analysis of Selected Wastewater Reuse Opportunities in Big Bear Valley Final Report. NBS/Lowry. July 1990 (BBARWA)

Geohydrologic Evolution of Artificial Recharge Potential of the Sand Canyon Area. GEOSCIENCE Support Services, Inc. January 1991 (BBARWA)

Report of Waste Discharge/Engineering Report on the Proposed Use of Reclaimed Municipal Wastewater for Groundwater Recharge for the Department of Water and Power City of Big Bear Lake. Black & Veatch. March 1991 (DWP)

Proposed Recycled Water Project "A View to the Future" Engineers Report Pursuant to Section 60323 Title 22, California Code of Regulations. Engineering Resources of Southern California, Inc. November 1998 (BBARWA)

Long Range Facilities Plan. Engineering Resources of Southern California, Inc. March 2000 (BBARWA)

Water Reuse Strategic Plan. Big Bear Area Regional Wastewater Agency. August 2000 (BBARWA)

2000 Urban Water Management Plan. Big Bear City Community Services District. March 2001 (CSD)

2000 Urban Water Management Plan. City of Big Bear Lake Department of Water and Power. March 2001 (DWP)

Re-Evaluation of the Maximum Perennial Yield Big Bear Lake Watershed and a Portion of Baldwin Lake Watershed. GEOSCIENCE Support Services, Inc. August 2001 (DWP)

Investigation of Areas of Potential Artificial Recharge – Baldwin Lake Area. GEOSCIENCE Support Services, Inc. October 2001 (BBARWA)

Studies on the Effect of Tertiary Treated Water on the Endangered Shay Creek Unarmored Threespine Stickleback Fish. 2002 Annual WaterReuse Symposium. Schindler paper and presentation. September 2002 (BBARWA)

Economic Value of Reliable Water and Wastewater Services. A&N Technical Services, Inc. October 2002 (BBARWA)

Identification, Evaluation, & Preliminary Analysis of Available Wastewater Treatment Processes (in Support of Groundwater Artificial Surface Recharge): Final Report. SEATRA Systems and Engineering Resources of Southern California, Inc. February 2003 (BBARWA)

Non-Potable Water System Preliminary Project-Big Bear Schools, Park, and Cemetery. Engineering Resources of Southern California, Inc. February 2003 (BBARWA)

Preliminary Estimated Costs to Obtain State Project Water for the Big Bear Valley. Engineering Resources of Southern California, Inc. March 2003 (BBARWA)

The Big Bear Valley Groundwater Replenishment Study Analysis and Identification of Alternatives to Address Disposal of RO Membrane Concentrated Waste Stream (Brine) Technical Memorandum Report. CH2MHILL. June 2003 (BBARWA)

Sewer System Analysis Final Report. So & Associates. June 2003 (BBARWA)

Recycled Water User Reclamation Plan. Engineering Resources of Southern California, Inc. July 2003 (BBARWA)

Connection Fee Analysis Final Report. So & Associates. September 2003 (BBARWA)

A Timeline of Evolving Wastewater Management in the Big Bear Valley. Schindler. September 2003 (BBARWA)

Groundwater Feasibility Study and Recycled Water Program Public Outreach Strategic Plan. TRG & Associates. January 2004 (BBARWA)

Potential Funding Opportunities for the Big Bear Area Regional Wastewater Agency Recycled Water Program. CH2MHILL. March 2004 (BBARWA)

Geohydrologic Analysis of Shay Pond. GEOSCIENCE Support Services, Inc. April 2004 (CSD)

Engineering Report for Water Reuse Permits. Engineering Resources of Southern California, Inc. June 2004 (BBARWA)

Geohydrologic Evolution of Artificial Recharge Potential in the Big Bear Valley, San Bernardino County, California. Volume I and II. GEOSCIENCE Support Services, Inc. July 2004 (BBARWA)

Presentation of Opinion Research Prepared for Big Bear Area Regional Wastewater Agency. Evans/McDonough Company, Inc. August 2004 (BBARWA)

Status Report – Public Outreach Activities. TRG & Associates. August 2004 (BBARWA)

Technical Review Panel comments Regarding BBARWA Groundwater Recharge Program. Bouwer, Cline and Perry. August 2004 (BBARWA)

Recycled Water Master Plan, Final Draft Report. CH2MHill. January 2005 (BBARWA)

Status Report on the Big Bear Area Regional Wastewater Agency Recycled Water Program, Final Report. CH2MHill. February 2005 (BBARWA)

Analysis of Ground Water flow Model Simulations for the Proposed Green Spot Artificial Recharge Site, Draft Report. GEOSCIENCE Support Services, Inc. March 2005 (Still being developed)



Appendix D. Potential Recycled Water Users & Demands

User ID	Potential Recycled Water User	Total Annual Demand (AFY)	Max Day Demand (gpm)	Peak Hour Demand (gpm)	Demand Estimate Data Source
1	North Shore Elementary School	8.6	16	49	BBLDWP Consumption Records (2011-2014)
2	Rotary Pine Knot Park	2.6	5	15	BBLDWP Consumption Records (2011-2014)
3	Veterans Park	2.3	4	12	BBLDWP Consumption Records (2011-2014)
4	Meadow Park	0.9	1	4	BBLDWP Consumption Records (2011-2014)
5	Big Bear Middle School	12.6	21	64	BBLDWP Consumption Records (2011-2014)
6	Big Bear Elementary School	5.1	8	23	BBLDWP Consumption Records (2011-2014)
7	Big Bear Snow Play	0.1	0	1	BBLDWP Consumption Records (2011-2014)
8	City of Big Bear Lake City Hall and Village Streetscape	0.6	1	3	BBLDWP Consumption Records (2011-2014)
9	World Mark (Timeshare Resort)	20.6	29	88	BBLDWP Consumption Records (2011-2014)
10	Big Bear High School	22.2	37	110	BBCCSD Consumption Records (2011-2014)
11	Stickleback	37.8	35	35	BBCCSD Consumption Records (2011-2014)
14	Big Bear Airport District (Landscaping Meter)	0.6	1	3	BBCCSD Consumption Records (2011-2014)
15	Church of Jesus Christ Latter Day Saints	1.8	3	9	BBCCSD Consumption Records (2011-2014)
16	Erwin Lake Park	1.6	2	7	BBCCSD Consumption Records (2011-2014)
17	Gold Mountain Memorial Park (Cemetery)	0.0	0	0	BBCCSD Consumption Records (2011-2014)
22	Sonny's Place Equestrian Center	0.0	0	0	BBCCSD Consumption Records (2011-2014)
23	Whispering Pines	8.3	14	41	BBCCSD Consumption Records (2011-2014)
25	Chautauqua High School B	2.1	5	14	BBCCSD Consumption Records (2011-2014)
27	Paradise Park (Proposed)	3.0	6	17	BBCCSD Consumption Records (2011-2014)
28	Big Bear Golf Course	120.0	236	707	BBCCSD Estimate
30	The Ranch	1.6	2	7	BBLDWP 2010 UWMP
31	Alpine Zoo	1.5	4	13	Initial Study for Alpine Zoo
33	Baldwin Lake Elementary	7.7	11	32	2006 RWMP
34	Sugarloaf Park	22.0	31	92	2006 RWMP
35	Otto Lawrence (Inn Der Bach)	0.5	1	2	BBCCSD Consumption Records (2011-2014)

Appendix E. Technical and Financial Assumptions

TECHNICAL ASSUMPTIONS

The table below summarizes the key technical assumptions used to develop the alternatives.

Project Element	Assumption
Dilution Water - Advanced Treated Recycled Water	Advanced treated water qualifies as dilution water will require no dilution water
Dilution Water Sources	Sources are storm water, basin underflow and advanced treated wastewater
Beneficial Yield	Beneficial Yield is equal to the yield entering the recycled water distribution system following the WWTP. It is assumed that 100% of the recycled water recharged is recoverable as supply.
Pipelines	Sized to maintain a headloss gradient of less than 10 ft of headloss per 1000 ft of pipeline during peak hour for irrigation use and average annual for recharge use.
Pump Stations	Capacity based on peak hour demand for irrigation use and average annual for recharge use. (Assumes no gravity system storage) Station efficiency is assumed to be 75% All pumps have Variable Frequency Drives (VFDs)
Storage	Capacity is based on max day demand for irrigation use and average day demand for recharge use
Advanced Treatment Recovery Percentage	The net recovery of water entering the Advanced Treatment process is 85%; 15% is generated as brine.

FINANCIAL ASSUMPTIONS

Planning Level Cost Estimates

The cost opinions (estimates) included in this Study are prepared in conformance with industry practice and, as planning level cost opinions, will be ranked as a Class 4 Conceptual Opinion of Probable Construction Cost as developed by the Association for the Advancement of Cost Engineering (AACE) Cost Estimate Classification System (19). The AACE classification system is intended to classify the expected accuracy of planning level cost opinions, and is not a reflection on the effort or accuracy of the actual cost opinions prepared for the study. According to AACE, a Class 4 Estimate is intended to provide a planning level conceptual effort with an accuracy that will range from -30% to +50% and includes an appropriate contingency for planning and feasibility studies. The conceptual nature of the design concepts and associated costs presented in this Study are based upon limited design information available at this stage of the projects. These cost estimates have been developed using a combination of data from RS Means CostWorks®, recent bids, experience with similar projects, current and foreseeable regulatory requirements and an understanding of the necessary project components. As specific projects progress, the design and associated costs could vary significantly from the project components identified in this Study. Cost opinions are planning level and may not fully account for site-specific conditions that will affect the actual costs, such as soils conditions and utility conflicts.

For projects components where applicable cost data is available in RS Means CostWorks® (e.g. pipeline installation), cost data released in Quarter 4 of 2015, adjusted for San Bernardino, California, is used. Material prices were adjusted in some cases to provide estimates that align closer with actual local bid results. For projects where RS Means CostWorks® data is not available, cost opinions are generally derived from bid prices from similar projects, vendor quotes, material prices, and labor estimates, with adjustments for inflation, size, complexity and location.

Cost opinions are in 2015 dollars (ENR 20 City Average Construction Cost Index of: 10,039 for August 2015).

Markups and Contingencies

For the development of the planning level cost estimates, several markups and contingencies are applied to the estimated construction costs to obtain the total estimated project costs. The markups are intended to account for costs of engineering, design, administration, and legal efforts associated with implementing the project (collectively, Implementation Markup). Contingency accounts for additional construction costs that could not be anticipated at the time of this analysis. A summary of the markups and contingencies applied are presented in the table below.

Markups and Contingencies	
	Construction Subtotal
+	20% of Construction Subtotal for Contingency
+	30% of Construction Subtotal for Non-Potable Reuse Implementation (Alternative 1) 40% of Construction Subtotal for Groundwater Recharge Implementation (Alternatives 2 & 3)
=	Total Capital Cost

Excluded cost are as follows:

- Public Information Program. Depending on the relative public acceptability of a major recycled water facility or a group of facilities, there may be a need for a public information program, which could take many different forms. It is recommended that the agencies engage in a proactive public outreach program in coordination with other existing or planned outreach programs.
- Land Acquisition. Additional land and/or easements may need to be acquired in addition to those explicitly accounted for in the cost estimates.

Unit Cost and Net Present Value

Unit costs of the various alternatives are compared using the annual payment method. The unit cost is calculated with this method by adding the annual payment for borrowed capital costs to the annual O&M cost and dividing by the annual project yield. This method provides a simple comparison between alternatives in this RWFPS. The factors described below are used to calculate the unit cost with the annual payment method.

To comply with USDA funding program requirements for a Preliminary Engineering Report, the net present values (NPV) are also calculated for each alternative and treatment option. The NPVs account for capital costs (one-time costs associated with each alternative) and operation and maintenance (O&M) costs (i.e. electrical and maintenance) over a 30-year period. O&M costs are subdivided into Conveyance Pumping Energy costs and Non-Energy costs to enable these costs to be escalated at different rates in the future, recognizing that energy costs are anticipated to rise faster than non-energy costs. Note that unit costs calculated using the NPV will not correspond to the unit costs presented in this report, which are based on the annual payment method.

The assumptions used to calculate the costs for each alternative are summarized in the table below.

Assumption	Current Value	Annual Escalation Rate	Description
Loan Terms	100% loan for 30-year loan term with a 2.2% capital financing rate		Loan term based on CWSRF loan term. Capital financing rate based on SRF previous 10-year average.
Discount Rate			A Discount Rate of 3% is used for the NPV
O&M – Conveyance Pumping Energy	\$ 0.14/ KW-hr	3.0 %	Energy escalation based on US Energy Information Administration (USEIA) previous 5-year average electricity rate data for California Commercial rates.
O&M – Non Energy	Varies by facility type, based on capacity or capital cost	2.4%	Non-energy escalation based on California CCI previous 5-year average

Appendix F. Treatment Upgrade Details

ALTERNATIVE 1: DISINFECTED TERTIARY TREATMENT

Alternative 1 requires the RW is treated to disinfected tertiary standards, per the Title 22 Code of Regulations as follows:

- Filtered through a process that produces tertiary effluent with a turbidity that does not exceed an average of 2 NTU within a 24-hour period, 5 NTU (0.2 NTU for MF) more than 5% of the time within a 24-hour period, or 10 NTU at any time (0.5 NTU for MF).
- Disinfected to produce effluent that does not exceed an average MPN of 2.2 per 100 mL in past 7 days or an MPN of 23 per 100 mL in any one sample in past 30 days, and never exceeds an MPN of 240 total coliform bacteria per 100 mL.

The new treatment processes required at the BBARWA WWTP to produce disinfected tertiary include:

- Tertiary filtration
- Disinfection

A process flow diagram (PFD) for Alternative 1 is shown below and each process is described in more detail in the following subsections. The new facilities required for this alternative are outlined in blue.

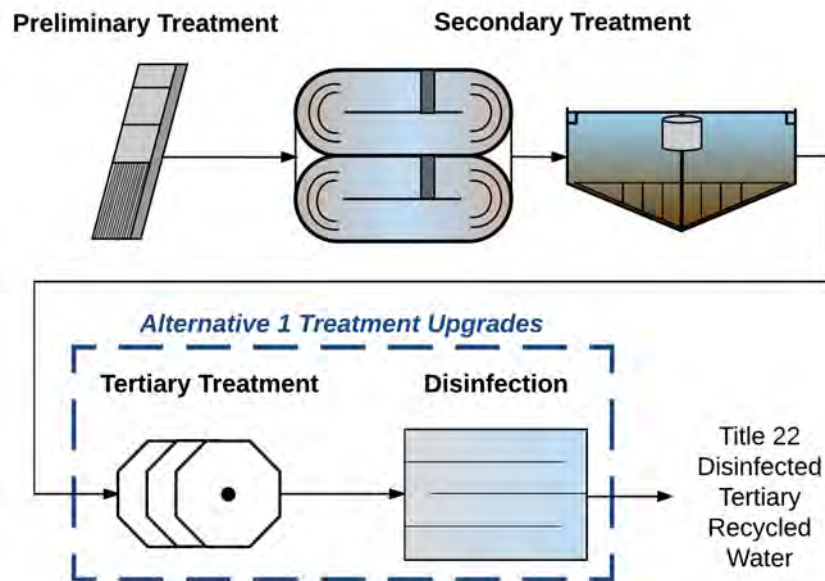
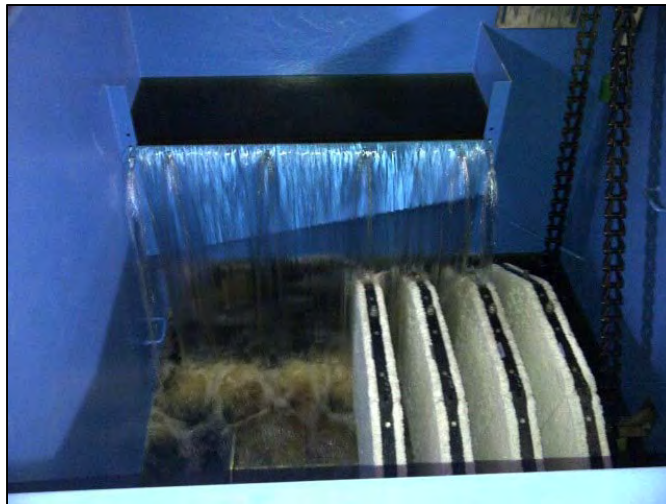

Figure 10-1 Treatment Process Flow Diagram for Alternative 1

Tertiary Filtration

Tertiary filtration is intended to remove TSS from secondary effluent prior to the disinfection process. Either surface filtration or depth filtration mechanisms may be used to perform tertiary filtration. Surface filtration units include cloth-medium surface filters, and depth filtration includes upflow and down flow media filters. Cloth media filters were selected as the tertiary filtration process because the technology is offered by multiple vendors, easy to operate and low cost. Cloth media filter units have a compact footprint and the process can be easily expanded to include additional modules for treating the total Alternative 1 reuse demand of 0.24 MGD.

The surface filtration mechanism of a cloth media filter works by an outside-in pattern of the secondary effluent wastewater flow. The cloth media filters operate submerged, rotating slowly as the water filters through the surface of the cloth, depositing solids on the outside of the media while allowing filtered water (filtrate) to flow by gravity to the effluent channel. Backwash of the cloth media filters is initiated when the solids deposited on the cloth media create too much headloss. During backwash, the flow is reversed as the cloth filters continue to rotate and vacuum suction manifolds are turned on to remove solids that were deposited on the media surface. Intermittent shutdowns are required for more intensive backwash events to remove solids that are not removed from standard backwash cycles. The effluent channel is hydraulically separated from the process tank so headloss can be measured using the water level in the effluent channel. A photo of a cloth media filter unit is shown below.



Operational characteristics that govern design of cloth filters include average and peak hydraulic loading rates (HLR). CDPH has established an allowable peak HLR of 6 gpm/sf for many of the approved cloth surface media filters, although different HLRs may be permitted for varying models of the process. Typically, cloth media filters operate between 2 to 5 gpm/sf during average conditions.

Disinfection

Title 22 standards require the RW used for unrestricted landscape irrigation is “filtered” and “disinfected”. The disinfection process is intended to remove and inactivate viruses, bacteria and protozoa from the wastewater to make it safe for RW uses. The most common disinfection processes used for wastewater treatment are ultraviolet disinfection, ozonation and chlorination. Chlorination was selected as the disinfection process because the BBARWA staff is familiar with chlorine dosing systems, and chlorination provides adequate disinfection to reliably produce disinfected tertiary RW.

ALTERNATIVE 2: ADVANCED TREATMENT UPGRADES

For Alternative 2, BBARWA’s existing secondary treatment and clarification facilities are assumed to be sufficient for adequate BOD and TSS removal prior to tertiary treatment. The secondary effluent from the existing WWTP would be fed to the advanced treatment process train consisting of:

1. Microfiltration/ultrafiltration (MF/UF)
2. Reverse Osmosis (RO)
3. Ultraviolet Advanced Oxidation (UV/AOP)
4. Brine Reduction

The combination of MF, RO and UV/AOP is considered the conventional indirect potable reuse treatment train. This treatment train meets the criteria in the DDW Regulations Related to Recycled Water (Title 22, Article 5.2). A PFD for Alternative 2 is shown below. The new facilities required for this alternative are outlined in blue.

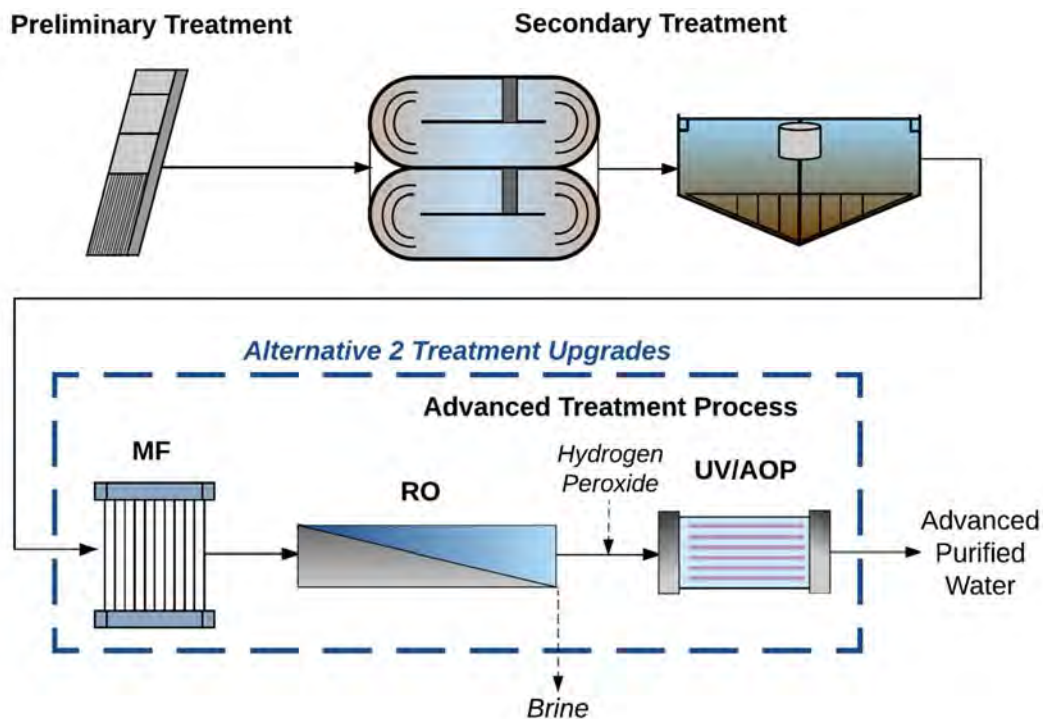

Microfiltration

MF membranes are an efficient technology for particle removal and pathogen control either in a pressurized or submerged configuration. For the former, water is pumped through the membranes in modules or cartridges. In the latter form, membranes are submerged in tanks and water is pulled through the membranes by vacuum. Overall, membrane filtration provides a near absolute barrier to suspended solids and microorganisms.

For this analysis, pressurized MF membranes were assumed as they generally provide greater efficiency and lower operating costs at this flow range. As water is pushed through the membranes using feed pumps, the suspended solids and microorganisms are retained on the outside of the membrane. As long as the integrity of the membranes are maintained, MF finished water turbidities will be consistently below 0.1 NTU, independent of feed water quality. Due to high-quality effluent produced, MF has been shown to be the preferred pretreatment for RO systems treating wastewater.

Reverse Osmosis

High-pressure membrane processes, such as RO, are typically used for the removal of dissolved constituents including both inorganic and organic compounds. RO is a process in which the mass-transfer of ions through membranes is diffusion controlled. The feed water is pressurized, forcing water through the membranes, thereby concentrating the dissolved solids that cannot pass through the membrane. Consequently, these processes can remove salts, hardness, synthetic organic compounds, disinfection by-product precursors, etc. However, dissolved gases such as hydrogen sulfide (H₂S) and carbon dioxide, and neutral low molecular weight molecules, pass through RO membranes. The rejection by the RO membranes (removal efficiency) is not the same for all dissolved constituents, and is influenced by molecular weight, charge, and other factors.

RO is considered a high-pressure process because it operates from 75 to 1,200 psig, depending upon the TDS concentration of the feed water. Typical operating pressure in a wastewater application is in the range of 150 to 250 psi. Recoveries for RO plants operating on domestic wastewater are around 85 percent depending on the type and concentrations of sparingly soluble salts (calcium sulfate, calcium carbonate, calcium phosphate, silica, etc.) in the feed water. Silica can permanently scale RO membranes when its concentration in the process exceeds about 100 to 120 mg/L. In wastewater applications, calcium phosphate can often be the salt controlling overall recovery.

One of the issues with the RO process is discharge of the concentrate stream. The TDS removed from the feed water is concentrated in the brine stream and needs to be disposed. See Brine Reduction and Disposal.

Ultraviolet Advanced Oxidation Process

In general, advanced oxidation processes are processes that rely on chemical reactions with hydroxyl or other radicals to remove organic compounds in water. For a UV-based advanced oxidation process, a chemical oxidant is added to the process, and with exposure to the UV light, hydroxyl or other radicals are formed. The hydroxyl or other radicals are high-energy, highly reactive molecules that attack chemical bonds of organic molecules and oxidize them. UV/AOP is effective at oxidizing certain CECs such as certain endocrine disrupting compounds, PPCPs, and other microconstituents such as 1,4-dioxane and N-nitrosodimethylamine (NDMA) that can be found in wastewater effluents. In addition, with a UV/AOP process, the UV dose required for radical formation is greater than required for disinfection. Thus, a UV/AOP process provides both a disinfection barrier as well as a microconstituent barrier.

There are several chemical oxidants that can be used in combination with UV to achieve advanced oxidation. Hydrogen peroxide (H₂O₂) is a common oxidant used for advanced oxidation. Other chemical oxidants that can be combined with UV include ozone and hypochlorite. Each of these chemical oxidants have advantages and disadvantages.

Brine Reduction and Disposal

VSEP for Brine Reduction

Vibratory Shear-Enhanced Processing (VSEP), a patented process of New Logic, was developed to reduce polarization of suspended colloids and sparingly soluble salts on the membrane surface by introducing shear to the membrane surface through vibration.

The VSEP consists of four components: driving system that generates vibration, a membrane module, a torsion spring that transfers vibration to the membrane module and a system for controlling vibration. The vibration imparts a shear to the surface of the membrane to mitigate fouling and scaling that would occur in a conventional RO system. The membrane module houses a stack of flat membrane sheets (filter pack) in a plate and- frame type configuration.

Unlike conventional RO systems, VSEP is not limited by the solubility of minerals or the presence of suspended solids. It can be used in the same applications as crystallizers or brine concentrators and is capable of high recoveries (up to 90 percent). The VSEP system can be configured employing either RO or NF membranes in a single-stage or multiple-stage arrangement. The configuration depends upon quality of the wastewater to be treated, water quality goals for the VSEP permeate, and target water recovery, making it a viable option for brine reduction.

Based on the results of this study and pilot testing of brine treatment and disposal alternatives for the BBARWA WWTP, the recommended method of brine disposal was effluent mixing coupled with brine reduction and evaporation ponds (16). Under this scenario, a portion of the brine would be mixed with the secondary effluent that is discharged to the LV Site for irrigation. The portion of brine that is mixed would be limited to ensure that the effluent meets the discharge requirements of the Colorado WDR permit for the LV Site. For the remaining brine, VSEP would be used to reduce the volume of concentrate. The reduced concentrate would then be conveyed to new, lined evaporation ponds on the LV Site. A smaller brine pipeline would be installed inside the existing discharge pipeline to the LV Site. A simplified PFD depicting this scenario is presented below.

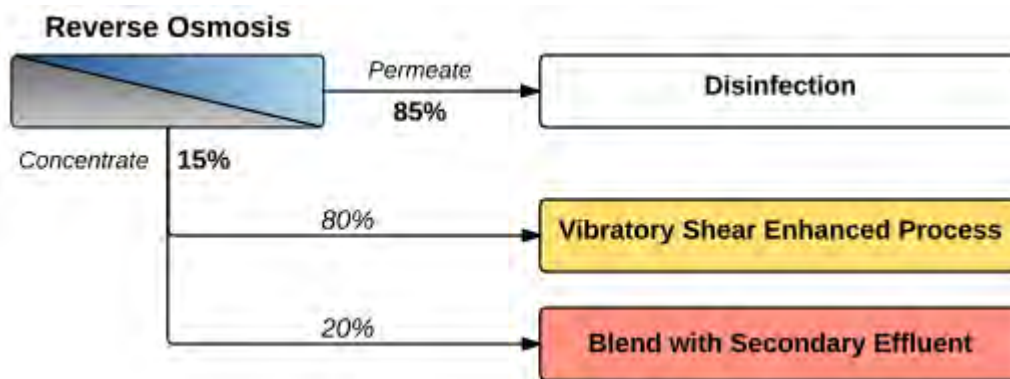

ALTERNATIVE 3: SATELLITE ADVANCED TREATMENT PLANT

For Alternative 3, a new satellite WWTP would be constructed near BBARWA's existing Lake Pump Station. The new treatment processes required for this alternative include:

1. Primary Treatment
2. Secondary and Tertiary Treatment. A Membrane Bioreactor (MBR) process is assumed.
3. Reverse Osmosis (RO)
4. Ultraviolet Advanced Oxidation (UV/AOP)
5. Brine Disposal

The combination of MBR, RO and UV/AOP is considered a conventional indirect potable reuse treatment train. This treatment train meets the criteria in the DDW Regulations Related to Recycled Water (Title 22, Article 5.2). One of the issues with the RO process is that the TDS removed from the feed water is concentrated into a brine stream that needs to be disposed of. A PFD for Alternative 3 is shown below. The new facilities required for this alternative are outlined in blue.

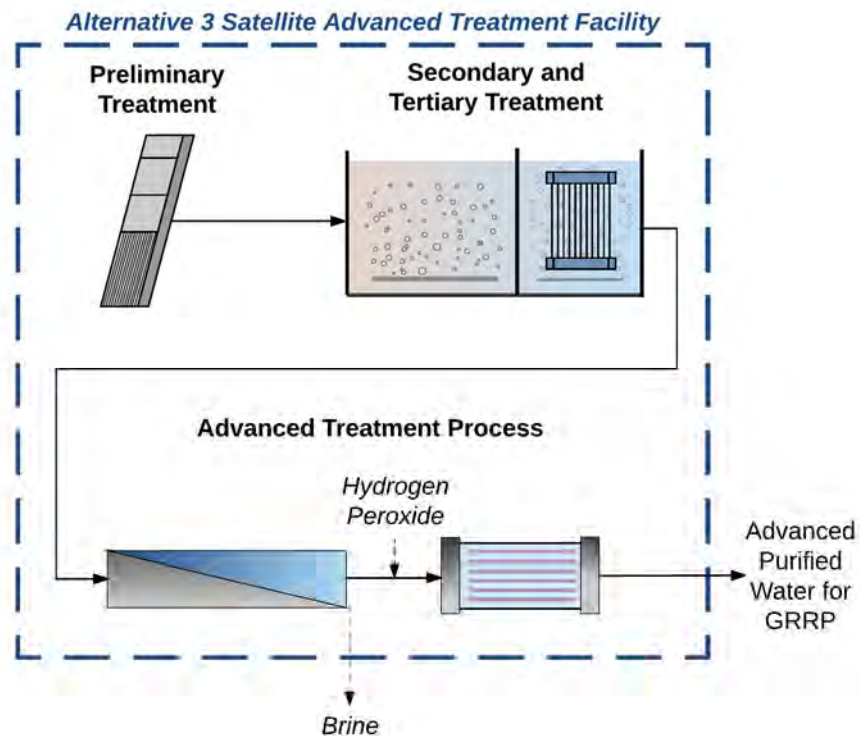

Preliminary Treatment

Preliminary treatment is required to remove debris such as branches and trash, and inert solids such as grit. The removal of these materials is necessary to protect downstream equipment and improve performance of downstream processes. For Alternative 3, it is assumed the preliminary treatment process would consist of a mechanical bar screen, a coarse air grit tank and a fine screen.

Large debris is typically removed using mechanical bar screens that trap objects in front of bars spaced 1-in. to 2-in. apart and remove the material with mechanical rakes. Grit and inorganic solids are removed using either coarse aeration or mechanical vortex grit tanks. The mechanisms for grit removal suspend the organic solids that are finer and lighter, while the coarse, heavy solids settle to the bottom of the tank to be removed through a hopper.

Fine screening is required for MBR treatment applications to remove small abrasive solids that have the potential to damage the membrane fibers. Fine screens are placed immediately upstream of the biological treatment and MBR tanks (secondary and tertiary treatment). The physical straining of fine solids is performed by passing the flow through 0.01-in. to 0.25-in. openings in drum, band, or static screen surfaces. The retained solids are continually washed off or transferred to a solids conveyance belt for processing.

Membrane Bioreactor

MBRs are an established technology for particle removal and pathogen control, intended for application downstream of an activated sludge process. MF modules are submerged in tanks and water is pulled through the membranes by filtrate pumps. Membrane filtration provides a near absolute barrier to suspended solids and microorganisms.

For this analysis, MBRs were assumed because the satellite plant will likely include a pre-constructed secondary process unit equipped with an activated sludge process and MBR unit. As water is filtered through the membranes, the suspended solids and microorganisms are retained on the outside of the membrane. As long as the integrity of the membranes are maintained, MBR effluent turbidities are consistently below 0.1 NTU, independent of feed water quality. Due to high-quality effluent produced, MBRs have been shown to be the preferred pretreatment for RO systems treating wastewater.

However, there are currently no pathogen log reduction credits in place for an MBR with DDW for the purposes of permitting a groundwater recharge project. The lack of credits is attributed to the inability to perform proper membrane integrity testing on the MBR membrane that is commonly performed on tertiary MF or UF membranes. It is anticipated that some level of pathogen log reduction credits will be in place for MBRs in the near future, but additional treatment processes may be required if MBR treatment receives insufficient credits.

Reverse Osmosis

A description of the reverse osmosis process is included in the Treatment Upgrade Details for Alternative 2 earlier in this Appendix.

Ultraviolet Advanced Oxidation Process

A description of the UV/AOP process is included in the Treatment Upgrade Details for Alternative 2 earlier in this Appendix.

Brine Disposal

It is assumed the brine stream from the satellite advanced treatment system will be delivered back to the wastewater collection system to be managed at the BBARWA WWTP.

ALTERNATIVE 4: ADVANCED TREATMENT UPGRADES

The treatment upgrades required for implementation of Alternative 4 are identical to Alternative 2, but at a larger scale. The new treatment processes required for Alternative 4 are:

1. Microfiltration/ultrafiltration (MF/UF)
2. Reverse Osmosis (RO)
3. Ultraviolet Advanced Oxidation (UV/AOP)
4. Brine Reduction

Refer to the Treatment Upgrade Details for Alternative 2 for details of the treatment upgrades required for Alternative 4. A PFD for Alternative 4 is shown below. The new facilities required for this alternative are outlined in blue.

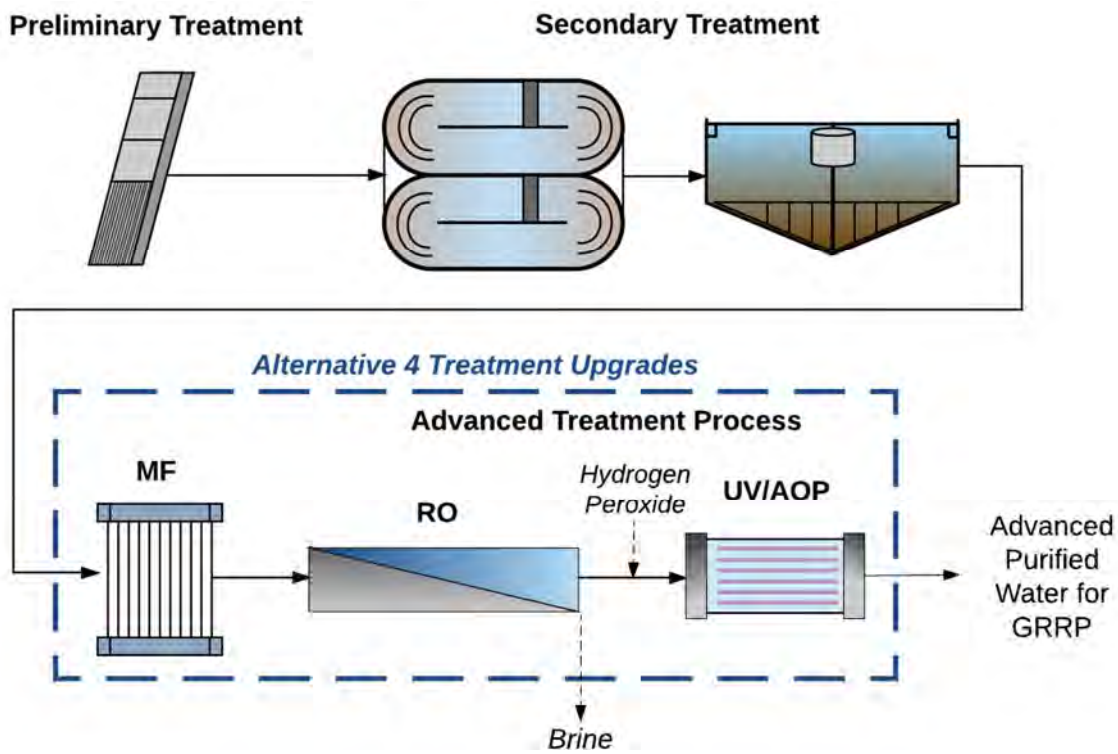

ALTERNATIVE ADVANCED TREATMENT TECHNOLOGIES

As an inland community, the Big Bear Agencies' most significant barrier to implementing an alternative with advanced treatment is the cost of brine management. Unlike coastal communities, the Big Bear Valley does not have the advantage of discharging brine to the ocean. Communities similar to the Big Bear Valley often identify brine management costs as a financial barrier to implementing the project, which highlights the need for alternative advanced treatment technologies for potable reuse applications. Engineering professionals and organizations such as WaterReuse have responded to this need by initiating research projects to evaluate alternative advanced treatment train performance compared to the conventional MBR-RO-UV/AOP treatment train.

A potential alternative advanced treatment technology for the BVWSP consists of an MBR or MF, followed by ozone oxidation and biologically activated filtration (BAF), as shown in the figure below.

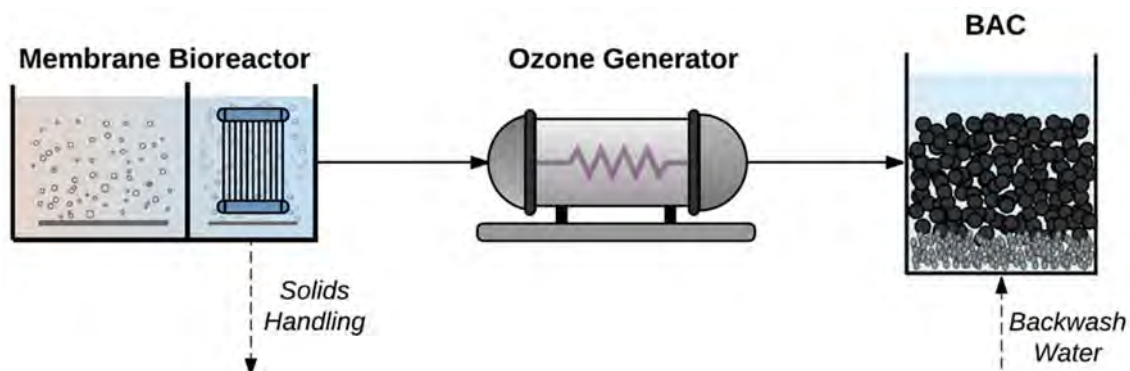

This alternative advanced treatment process has shown promise for effective TOC, pathogen and synthetic compound removal in cold climates such as Colorado. Despite the performance capabilities of alternative treatment technologies such as the MBR-Ozone-BAF train, without a physical mechanism for removing and separating salts from the effluent stream, the TDS of the RW would likely be too high to be permitted for artificial recharge anywhere in the Big Bear Valley Groundwater Management Zone. It is recommended the Big Bear Agencies investigate local brine management as a means of reducing the brine management costs associated with the advanced treatment alternatives considered for the BVWSP. The SAWPA BMPTF can assist the Bear Valley Agencies in initiating an assimilative capacity study for TDS in the Big Bear Valley Groundwater Management Zone. The results of the assimilative capacity study can be used to quantify the TDS removal requirements of the advanced treatment system and refine the costs of the BVWSP artificial recharge alternatives. Based on the results of the study, it is possible only a sidestream of the RW would need to undergo RO treatment, which would save significant capital and O&M costs.

Appendix G. Cost Detail for Recycled Water Alternatives

**Alternative 1
Non Potable Reuse**

Alternative Information																																				
Treatment Segment	Tertiary Upgrade - Cloth Filters 1.1				Tertiary Upgrade - Cloth Filters 1.2				Tertiary Upgrade - Cloth Filters 1.3				Tertiary Upgrade - Cloth Filters 1.4				Tertiary Upgrade - Cloth Filters 1.5				Tertiary Upgrade - Cloth Filters 1.6															
Segment Reuse Demand	0.05	MGD	54	AFY	0.00	MGD	3	AFY	0.00	MGD	0	AFY	0.11	MGD	121	AFY	0.04	MGD	44	AFY	0.01	MGD	9	AFY												
Cumulative Total Reuse Demand	0.05	MGD	54	AFY	0.05	MGD	57	AFY	0.05	MGD	57	AFY	0.16	MGD	178	AFY	0.20	MGD	223	AFY	0.21	MGD	231	AFY												
Capital Cost																																				
	Capacity/Size				Length				Capacity/Size				Length				Capacity/Size				Length															
RW Main - 1	8	in	8370	LF	\$	921,000	12	in	11350	LF	\$	2,259,000	12	in	11480	LF	\$	2,285,000	10	in	6075	LF	\$	765,000	6	in	12125	LF	\$	1,176,000	4	in	7600	LF	\$	661,000
RW Main - 2	6	in	2070	LF	\$	201,000					\$	-					\$	-					\$	-	4	in	7870	LF	\$	685,000					\$	-
RW Main - 3	4	in	1660	LF	\$	144,000					\$	-					\$	-					\$	-					\$	-					\$	-
Storage	0.12	MG			\$	156,000	0.01	MG			\$	13,000	0.0	MG			\$	-	0.35	MG			\$	455,000	0.10	MG			\$	130,000	0.02	MG			\$	26,000
Pump Station	248	gpm			\$	223,000	17	gpm			\$	25,000	0	gpm			\$	-	720	gpm			\$	519,000	205	gpm			\$	121,000	49	gpm			\$	28,000
Customer Conversions	5	EA			\$	150,000	1	EA			\$	30,000	0	EA			\$	-	2	EA			\$	60,000	6	EA			\$	180,000	1	EA			\$	30,000
Tertiary Treatment - Cloth Filters	0.05	MGD			\$	121,000	0.00	MGD			\$	7,000	0.00	MGD			\$	-	0.11	MGD			\$	275,000	0.04	MGD			\$	99,000	0.01	MGD			\$	25,000
Brine Management System																																				
Construction Subtotal					\$	1,916,000					\$	2,334,000					\$	2,285,000					\$	2,074,000					\$	2,391,000					\$	770,000
Construction Contingency					\$	383,000					\$	467,000					\$	415,000					\$	478,000					\$	478,000					\$	154,000
Implementation Costs					\$	575,000					\$	700,000					\$	686,000					\$	622,000					\$	717,000					\$	231,000
Land Purchase					\$	-					\$	-					\$	-					\$	-					\$	-					\$	-
Segment Total Capital Cost					\$	3,257,000					\$	3,968,000					\$	3,885,000					\$	3,526,000					\$	4,064,000					\$	1,309,000
Cumulative Total Capital Cost																																				
O&M Cost Estimates																																				
	Capacity/Size				Length				Capacity/Size				Length				Capacity/Size				Length															
Pipeline			12100	LF	\$	13,000			11350	LF	\$	23,000			11480	LF	\$	23,000			6075	LF	\$	8,000			19995	LF	\$	19,000			7600	LF	\$	7,000
Storage	0.12	MG			\$	2,000	0.01	MG			\$	-	0.0	MG			\$	-	0.35	MG			\$	5,000	0.10	MG			\$	2,000	0.02	MG			\$	1,000
Pump Station	248	gpm					17	gpm					0	gpm					720	gpm					205	gpm					49	gpm				
Maintenance					\$	11,000					\$	1,000					\$	-					\$	26,000					\$	6,100					\$	1,400
Power					\$	5,100					\$	200					-						\$	7,000					\$	-					\$	500
Tertiary Treatment - Cloth Filters	0.05	MGD			\$	3,000	0.00	MGD			\$	-							0.11	MGD			\$	8,000	0.04	MGD			\$	3,000	0.01	MGD			\$	1,000
Compliance Labor for RW					\$	31,000																														
Segment Total Annual O&M Cost					\$	65,000					\$	24,000					\$	23,000					\$	54,000					\$	30,000					\$	11,000
Cumulative Total Annual O&M Cost																																				
Annual Capital Payment					\$	149,000					\$	182,000					\$	178,000					\$	162,000					\$	186,000					\$	60,000
Year 1 O&M					\$	65,000					\$	24,000					\$	23,000					\$	54,000					\$	30,000					\$	11,000
Total Annual Payment					\$	214,000					\$	206,000					\$	201,000					\$	216,000					\$	216,000					\$	71,000
Annual Yield (AFY)						54						3						0						121						44						9
Unit Cost (\$/AF)					\$	3,960					\$	68,670					-						\$	1,780					\$	4,880					\$	8,250
Cumulative Annual Capital Payment					\$	149,000																	\$	522,000					\$	709,000					\$	769,000
Cumulative Annual O&M					\$	65,000																	\$	101,000					\$	131,000					\$	142,000
Total Cumulative Annual Cost					\$	214,000																	\$	623,000					\$	840,000					\$	911,000
Cumulative Annual Yield (AFY)						54																		124						169						177
Cumulative Unit Cost (\$/AF)					\$	3,960																	\$	5,010					\$	4,980					\$	5,140

Alternative 2
Greenspot Recharge

Alternative Information					
Treatment	Advanced Treatment Upgrade				
Blending Scenario	22% Tertiary, 78% Advanced				
Reuse Demand	0.89	MGD	1000	AFY	
Tertiary Treatment Capacity	1.01	MGD			
Advanced Treatment Capacity	0.82	MGD			
Capital Cost					
	Capacity/Size		Length		
RW Main - 1	12	in	16205	LF	\$ 3,225,000
Storage	0.9	MG			\$ 1,209,000
Pump Station	619	gpm			\$ 472,000
Tertiary Treatment Upgrade	1.01	MGD			\$ 2,847,000
Advanced Treatment Upgrade	0.82	MGD			\$ 5,156,000
Brine Management System	0.12	MGD			\$ 6,088,000
Recharge Basin	7	AC			\$ 700,000
Extraction Well	6	EA			\$ 6,624,000
Monitoring Well	2	EA			\$ 200,000
Construction Subtotal					\$ 26,521,000
Construction Contingency					\$ 5,304,000
Implementation Costs					\$ 10,608,000
Land Purchase					\$ 2,100,000
Segment Total Capital Cost					\$ 44,533,000
O&M Cost Estimates					
	Capacity/Size		Length		
Pipeline			16205	LF	\$ 32,000
Storage	0.9	MG			\$ 12,000
Pump Station	619	gpm			
Maintenance					\$ 24,000
Power					\$ 41,600
Tertiary Treatment	1.01	MGD			\$ 129,000
Advanced Treatment	0.82	MGD			\$ 568,000
Brine Management System	0.12	MGD			\$ 636,000
Compliance for Recycled Water					\$ 61,000
Recharge Basin	7	AC			\$ 35,000
Total Annual O&M Cost					\$ 1,539,000
Annual Capital Payment					\$ 2,043,000
Year 1 O&M					\$ 1,539,000
Total Annual Payment					\$ 3,582,000
Annual Yield (AFY)					1000
Unit Cost (\$/AF)					\$ 3,580

Alternative 3
Sand Canyon Recharge

Alternative Information											
Treatment	Advanced Treatment Upgrade					Advanced Treatment Upgrade					
Blending Scenario	30% Tertiary, 70% Advanced					55% Tertiary, 45% Advanced					
Reuse Demand	0.45	MGD	500	AFY		0.46	MGD	520	AFY		
Tertiary Treatment Capacity	0.50	MGD				0.50	MGD				
Advanced Treatment Capacity	0.37	MGD				0.25	MGD				
Capital Cost											
	Capacity/Size		Length				Capacity/Size		Length		
RW Main - 1	8	in	17420	LF	\$ 1,916,000	8	in	17420	LF	\$ 1,916,000	
Storage	0.0	MG			\$ -	0.0	MG			\$ -	
Pump Station	310	gpm			\$ 268,000	322	gpm			\$ 276,000	
Tertiary Scalping Plant	0.50	MGD			\$ 9,270,000	0.50	MGD			\$ 9,264,000	
Advanced Treatment Upgrade	0.37	MGD			\$ 3,293,000	0.25	MGD			\$ 2,628,000	
Brine Management System	0.00	MGD			\$ -	0.00	MGD			\$ -	
Recharge Basin	2.5	AC			\$ 250,000	2.5	AC			\$ 250,000	
Monitoring Well	2	EA			\$ 200,000	2	EA			\$ 200,000	
Construction Subtotal					\$ 15,197,000					\$ 14,534,000	
Construction Contingency					\$ 3,039,000					\$ 2,907,000	
Implementation Costs					\$ 6,079,000					\$ 5,814,000	
Segment Total Capital Cost					\$ 24,315,000					\$ 23,255,000	
O&M Cost Estimates											
	Capacity/Size		Length				Capacity/Size		Length		
Pipeline			17420	LF	\$ 19,000			17420	LF	\$ 19,000	
Storage	0.0	MG			\$ -	0.0	MG			\$ -	
Pump Station	295	gpm				322	gpm				
Maintenance					\$ 13,000					\$ 13,000	
Power					\$ 41,600					\$ 41,600	
Tertiary Scalping Plant	0.50	MGD			\$ 255,000	0.50	MGD			\$ 255,000	
Advanced Treatment	0.37	MGD			\$ 255,000	0.25	MGD			\$ 170,000	
Brine Management System	0.00	MGD			\$ -	0.00	MGD			\$ -	
New Plant Compliance					\$ 662,000					\$ 662,000	
Recharge Basin	2.5	AC			\$ 13,000	2.5	AC			\$ 13,000	
Total Annual O&M Cost					\$ 1,259,000					\$ 1,174,000	
Annual Capital Payment					\$ 1,116,000					\$ 1,067,000	
Year 1 O&M					\$ 1,259,000					\$ 1,174,000	
Total Annual Payment					\$ 2,375,000					\$ 2,241,000	
Annual Yield (AFY)					500					520	
Unit Cost (\$/AF)					\$ 4,750					\$ 4,310	
Deduct for Shared Lake Pipeline					\$ 190					\$ 190	
Unit Cost with Shared Lake Pipeline (\$/AF)					\$ 4,560					\$ 4,120	

Alternative 4
Combined Greenspot & Sand Canyon

Alternative Information					
Treatment	Advanced Treatment Upgrade				
Blending Scenario	22% Tertiary, 78% Advanced				
Reuse Demand	1.56	MGD	1750	AFY	
Tertiary Treatment Capacity	1.78	MGD			
Advanced Treatment Capacity	1.43	MGD			
Capital Cost					
	Capacity/Size		Length		
RW Main - 1	12	in	50182	LF	\$ 9,986,000
Storage	1.56	MG			\$ 2,028,000
Pump Station	1086	gpm			\$ 747,000
Tertiary Treatment Upgrade	1.78	MGD			\$ 3,808,000
Advanced Treatment Upgrade	1.43	MGD			\$ 7,053,000
Brine Management System	0.21	MGD			\$ 10,654,000
Recharge Basin	9.5	AC			\$ 950,000
Extraction Well	6	EA			\$ 6,624,000
Monitoring Well	4	EA			\$ 400,000
Construction Subtotal					\$ 42,250,000
Construction Contingency					\$ 8,450,000
Implementation Costs					\$ 16,900,000
Land Purchase					\$ 2,100,000
Segment Total Capital Cost					\$ 69,700,000
O&M Cost Estimates					
	Capacity/Size		Length		
Pipeline			50182	LF	\$ 100,000
Storage	1.56	MG			\$ 20,000
Pump Station	1086	gpm			
Maintenance					\$ 37,000
Power					\$ 111,300
Tertiary Treatment	1.78	MGD			\$ 226,000
Advanced Treatment	1.43	MGD			\$ 994,000
Brine Management System	0.21	MGD			\$ 1,113,000
Compliance for Recycled Water					\$ 76,250
Recharge Basin	9.5	AC			\$ 48,000
Total Annual O&M Cost					\$ 2,726,000
Annual Capital Payment					\$ 3,198,000
Year 1 O&M					\$ 2,726,000
Total Annual Payment					\$ 5,924,000
Annual Yield (AFY)					1750
Unit Cost (\$/AF)					\$ 3,390

Alternative 4
Combined Greenspot & Sand Canyon Phase 1

Alternative Information					
Treatment	Advanced Treatment Upgrade				
Blending Scenario	22% Tertiary, 78% Advanced				
Reuse Demand	0.39	MGD	440	AFY	
Tertiary Treatment Capacity	0.45	MGD			
Advanced Treatment Capacity	0.36	MGD			
Capital Cost					
	Capacity/Size		Length		
RW Main - 1	12	in	16205	LF	\$ 3,225,000
Storage	0.39	MG			\$ 507,000
Pump Station	273	gpm			\$ 241,000
Tertiary Treatment Upgrade	0.45	MGD			\$ 1,859,000
Advanced Treatment Upgrade	0.36	MGD			\$ 3,257,000
Brine Management System	0.05	MGD			\$ 2,679,000
Recharge Basin	3.5	AC			\$ 350,000
Extraction Well	3	EA			\$ 3,312,000
Monitoring Well	2	EA			\$ 200,000
Construction Subtotal					\$ 15,630,000
Construction Contingency					\$ 3,126,000
Implementation Costs					\$ 6,252,000
Land Purchase					\$ 1,050,000
Segment Total Capital Cost					\$ 26,058,000
O&M Cost Estimates					
	Capacity/Size		Length		
Pipeline			16205	LF	\$ 32,000
Storage	0.39	MG			\$ 5,000
Pump Station	273	gpm			
Maintenance					\$ 12,000
Power					\$ 15,400
Tertiary Treatment	0.45	MGD			\$ 57,000
Advanced Treatment	0.36	MGD			\$ 250,000
Brine Management System	0.05	MGD			\$ 280,000
Compliance for Recycled Water					\$ 76,250
Recharge Basin	3.5	AC			\$ 18,000
Total Annual O&M Cost					\$ 746,000
Annual Capital Payment					\$ 1,196,000
Year 1 O&M					\$ 746,000
Total Annual Payment					\$ 1,942,000
Annual Yield (AFY)					440
Unit Cost (\$/AF)					\$ 4,410

Alternative 4
Demonstration at Greenspot

Alternative Information					
Treatment	Advanced Treatment Upgrade				
Blending Scenario	22% Tertiary, 78% Advanced				
Reuse Demand	0.04	MGD	50	AFY	
Tertiary Treatment Capacity	0.05	MGD			
Advanced Treatment Capacity	0.04	MGD			
Capital Cost					
	Capacity/Size				
Storage	0.04	MG			\$ 52,000
Pump Station	500	gpm			\$ 86,000
Tertiary Treatment Upgrade	0.05	MGD			\$ 601,000
Advanced Treatment Upgrade	0.04	MGD			\$ 964,000
Recharge Basin	0.7	AC			\$ 70,000
Extraction Well	1	EA			\$ 1,104,000
Monitoring Well	2	EA			\$ 200,000
Construction Subtotal					\$ 3,077,000
Construction Contingency					\$ 615,000
Implementation Costs					\$ 1,231,000
Land Purchase					\$ 210,000
Segment Total Capital Cost					\$ 5,133,000
O&M Cost Estimates					
	Capacity/Size		Rate		
Water Tank Truck Rental			71	\$/hr	\$ 222,000
Storage	0.04	MG			\$ 1,000
Pump Station	500	gpm			
Maintenance					\$ 4,000
Power					\$ 76,600
Tertiary Treatment	0.05	MGD			\$ 6,000
Advanced Treatment	0.04	MGD			\$ 28,000
Compliance for Recycled Water					\$ 61,000
Recharge Basin	0.7	AC			\$ 4,000
Labor for Truck Operation	2	EA			\$ 187,200
Total Annual O&M Cost					\$ 590,000
Annual Capital Payment					\$ 236,000
Year 1 O&M					\$ 590,000
Total Annual Payment					\$ 826,000
Annual Yield (AFY)					50
Unit Cost (\$/AF)					\$ 16,520

Appendix H. Scoring Criteria Definitions

Qualitative & Non-Economic Evaluation Criteria

Definitions for each screening criteria and the corresponding scoring approach is described below.

1. **Promotes Water Supply Resiliency:** This criterion focuses on the benefits for improving water resource management and resiliency of water supply.
 - 3 = Significantly enhances management of water resources or supply resiliency
 - 2 = Provides some benefit for the management of water resources or supply resiliency
 - 1 = Does not affect management of water resources or supply resiliency

2. **O&M Complexity:** Focuses on the complexity of operating the treatment, distribution & administrative aspects of the alternative.
 - 3 = Simple O&M
 - 2 = Moderately complex O&M
 - 1 = Complex O&M

3. **Ease of Implementation:** Focuses on the construction sequencing, constructing phasing, jurisdictional considerations, permit acquisition and the ease of implementing the alternative.
 - 3 = Few barriers to implementation
 - 2 = Somewhat difficult to implement
 - 1 = Difficult to implement

4. **Benefit to Bear Valley Community:** Potential for the project to provide social, environmental, and water supply benefits to the Bear Valley community.
 - 3 = Significant benefit to the community
 - 2 = Moderate benefit to the community
 - 1 = Minimal benefit to the community

Appendix I. Fish Hatchery and Constructed Wetlands Concepts TM

Technical Memorandum



Date: 6/17/2016

To: Big Bear Area Regional Wastewater Agency

Prepared by: Emily Iskin, EIT

Reviewed by: Joshua Reynolds, P.E. and Laine Carlson, P.E.

Project: Bear Valley Water Sustainability Project

SUBJECT: DRAFT - FISH HATCHERY AND CONSTRUCTED WETLANDS CONCEPTS

Purpose

The purpose of the Fish Hatchery and Constructed Wetlands Concepts Technical Memo is to explore the viability of developing a recirculating fish hatchery near the BBARWA WWTP that utilizes recycled water to provide community benefits for the Big Bear Valley and potentially offset project costs for the Bear Valley Water Sustainability Project. Specifically, this memo summarizes the research compiled, sources gathered, and calculations conducted regarding the fish hatchery and treatment wetlands concepts. It should be noted that the results presented here reflect concept level analysis based primarily on empirical formulas. It is recommended that the Project team engage wetlands and fish hatchery experts to advance these concepts into the planning phase.

Fish Hatchery Concept

Existing Hatcheries

While preparing considering elements for the Big Bear hatchery concept, two California Department of Fish and Wildlife (CDFW) hatcheries operating nearby were evaluated for comparison. The data summarized in Table 1 present operation data for the Mojave River Hatchery and the Fillmore Trout Hatchery operate. The data was gathered through conversations with hatchery staff.

Table 1. CDFW Fish Hatchery Summary

Characteristic	Mojave River Hatchery	Fillmore Trout Hatchery
Fish Type	Primarily rainbow trout	Primarily rainbow trout
Annual Fish Production (lbs)	~360,000 to 400,000+	~320,000
Hatchery Flows (gpm)	6,500+	4,500 to 6,500+
Hatchery Configuration	6 raceways, 10' wide, 1,000' long	4 raceways, 10' wide, 1,000' long
Ponds per Raceway	10, in series	10, in series
Staffing Requirements	7 to 8 FTE plus occasional seasonal workers	6 to 7 FTE plus up to 2 seasonal workers
Source Water	Pumped underflow from Mojave River	Pumped groundwater
Discharge Water Treatment	Settling	None
Discharge Water Uses	Return flow, irrigation, recreation	Irrigation on adjacent farms

Conceptual Big Bear Hatchery and Wetlands

Figure 1 shows the conceptual layout of a potential Big Bear Hatchery at the BBARWA WWTP. It includes a constructed treatment wetland and a flow-through fish hatchery with tertiary treatment and recirculation. Depending on the chosen configuration for the remaining WWTP processes, treatment of blend water using constructed wetlands could potentially reduce size of a microfiltration facility, but there could also be regulatory and public perception challenges.

This analysis is based on a conceptual trout hatchery that produces 150,000 lbs of fish per year. These fish would be mostly 10” long and weigh approximately 0.45 lbs/fish (2.2 fish per lb). To determine the sizing of the wetlands, the hatchery flows are calculated first as fish production is the desired outcome. Figure 2 summarizes general trout hatchery water quality criteria. The water quality criteria affect the amount of treatment required through the wetlands.

Table 5. Water Quality Criteria for Trout Hatchery Water Supplies.

Parameter	Desirable Level
Dissolved oxygen	near saturation
Carbon dioxide	< 2.0 ppm
Temperature	45-65°F
pH	6.5-8.5
Total Alkalinity (as CaCO ₃)	10-400 ppm
Manganese	<0.01 ppm
Iron	<1.0 ppm
Zinc	<0.05 ppm
copper	<.006 ppm in soft water <0.3 ppm in hard water

Figure 1. Water Quality Parameters (Shelton 5)

It should be noted that even low concentrations of ammonia, although not shown in Figure 2, can be toxic to fish. Unionized ammonia (NH₃) levels depend on water chemistry (pH, alkalinity, and temperature). The rule of thumb is that NH₃ concentrations greater than 0.02 mg/L could be toxic to fish (5. Water Quality: Ammonia). Percent of total ammonia in freshwater based on water chemistry is summarized in Figure 3.

Table 8. Percent of Total Ammonia in the Unionized (NH₃) Form in Freshwater at Varying pH and Water Temperatures.

pH	TEMPERATURE		
	60°F	50°F	68°F
7.0	0.19	0.27	0.4
7.5	0.59	0.85	1.24
8.0	1.83	2.65	3.83
8.5	5.55	7.98	11.18

Figure 2. Percent of Unionized Ammonia (Shelton 9)

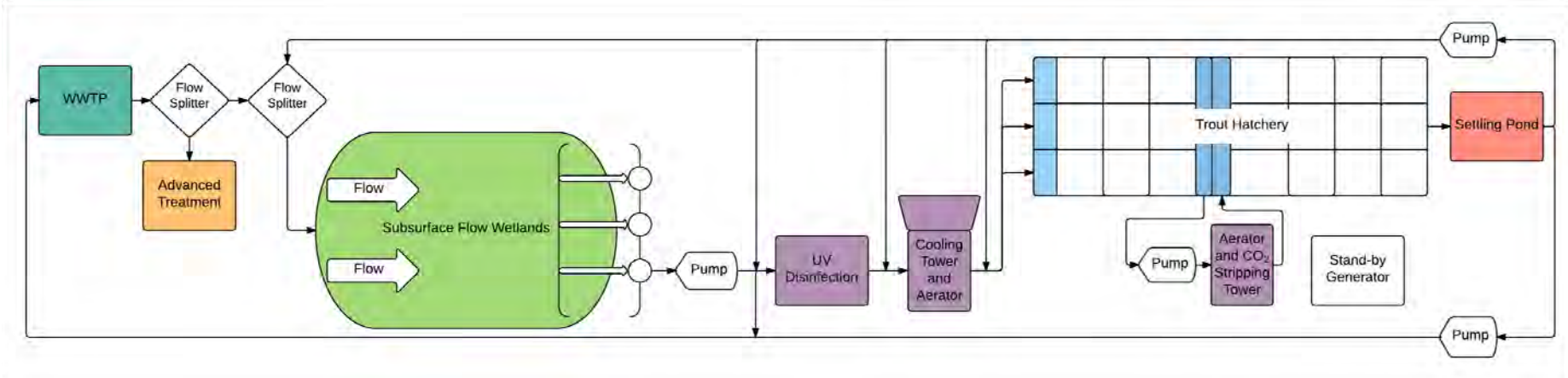

Figure 3. Conceptual Hatchery Process Diagram

Hatchery Calculations

The assumptions used in the conceptual design of the hatchery are summarized in Table 2.

Table 2. Big Bear Hatchery Characteristics

Characteristic	Value
Fish Size	10" long, 2.2 fish per lb
Weight of Fish per Year (lbs)	150,000
Hatchery Flows (gpm)	To be calculated
Hatchery Size	3 raceways, 10' wide, 800' long, 4' deep with 2' freeboard
Ponds per Raceway	8, in series

The calculations below summarize the method used to estimate the flow required to produce the desired 150,000 lb of fish. Equation 1 includes variable F, the Flow Index, "which takes flow rate into consideration when estimating maximum allowable weight of fish that a culture unit can hold," (Shelton 8). The flow is an important consideration because it "determines how rapidly fresh water will replace 'used' water (water in which fish have reduced dissolved oxygen concentrations and excreted waste products)," (Shelton 8). An F value of 0.75 was chosen because it is the middle of the range (0.5 to 1). This equation is empirical and assumes that the water is re-aerated after each pond.

Equation 1. Flow Required for a Trout Hatchery (Shelton 9)

$$Flow (gpm) = \frac{Weight (lbs fish)}{F * Length (in)}$$

$$Total flow = \frac{150,000 lbs fish}{0.75 * 10 in}$$

Total flow = 20,000 gpm total

Flow per raceway = 20,000 gpm/8 ponds/3 raceways

Flow per raceway = 833 gpm

Total flow required = 2,500 gpm

Conservative flow requirement = 3,000 gpm total

Compared to the Mojave and Fillmore hatcheries (which produce approximately twice as many fish with approximately twice this flow), a flow requirement of 3,000 gpm appears reasonable for the conceptual hatchery.

Wetlands Treatment Concept

Background

Constructed wetlands (CWs) can be used to treat effluent from a variety of processes including industrial wastewater, municipal wastewater, agricultural wastewater, landfill leachate, and stormwater runoff (Vymazal). For fish hatcheries specifically, major contaminants in fish farm effluent are fish food and fish waste (EPA Effluent Guidelines 7-2). CWs are a practical way to treat wastewater, as they require relatively low maintenance and have an approximate lifespan of 10-15 years before experiencing clogging (Cooper 24). Wetlands are great for Biological Oxygen Demand (BOD) reduction, but nitrification-denitrification (NDN) depends on the design of the wetland and pilot testing.

When it comes to types of CWs, there are both surface flow wetlands, where the water surface is above the filter/wetland media, and subsurface flow wetlands, where the water surface is below the media. Subsurface flow wetlands will be discussed here. This type of wetland performs better in cold climates, as the plant material and filter media insulate the subsurface flow (EPA Technology Assessment 2-1), and subsurface flow has a low total suspended solids (TSS) effluent which does not require filtration. There are two main types of subsurface constructed wetlands: horizontal flow (HF) and vertical flow (VF), which will be discussed in the next section.

Subsurface HF and VF CWs

The direction of fluid flow determines the category of CW. The flow in HF CWs flows in one side at the top, and out the other at the bottom as shown in Figure 4.

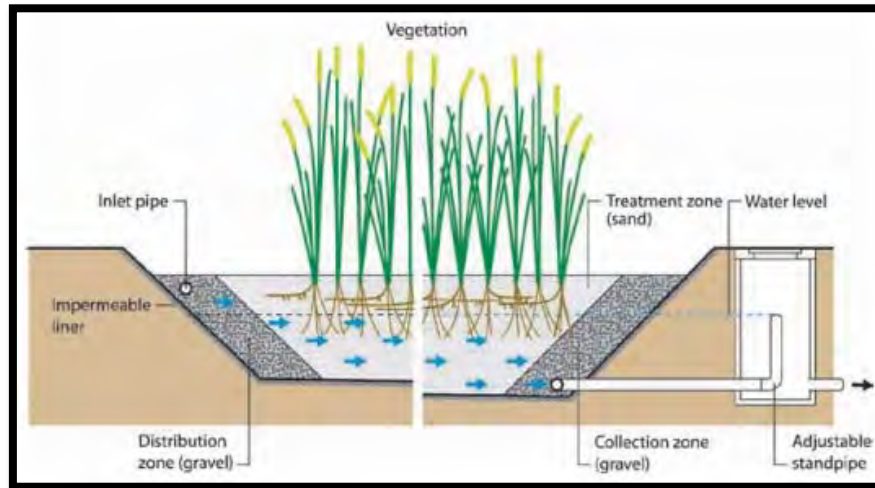

Figure 4. Horizontal Flow Wetland (Source: Greywater Management in Low and Middle-Income Countries)

The overall movement of fluid is horizontal. Because of this flow pattern, HF wetlands have very low oxygen concentrations, resulting in high denitrification ability (Vymazal 11). This is beneficial if the influent to the wetland has high concentrations of nitrates or nitrites. However, ammonia oxidation and removal occurs in an aerobic environment.

The flow to VF CWs enters along the top of the wetland media and exits along the bottom, as shown in Figure 5.

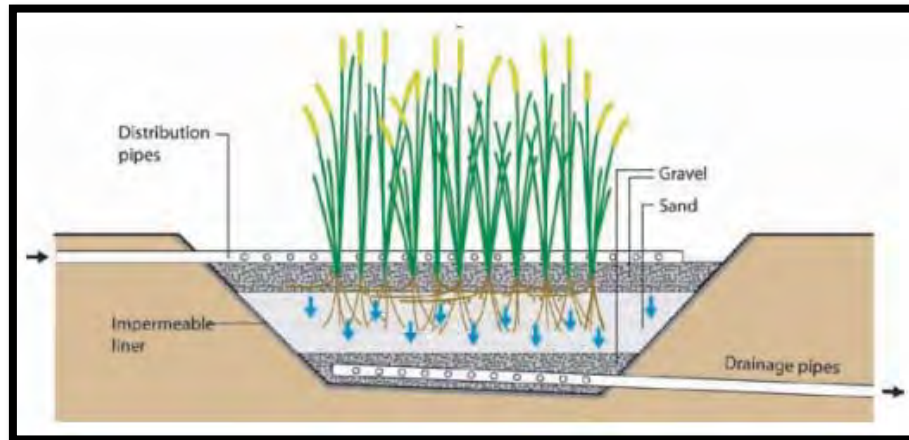

Figure 5. Vertical Flow Wetland (Source: Greywater Management in Low and Middle-Income Countries)

This flow pattern allows for a greater oxygen concentration in the subsurface wetland media, and results in high nitrification and ammonia removal ability (Vymazal 11). HF and VF CWs can be used in series to maximize the pollutant removal from the flow (Vymazal 11). “If the nitrification is achieved in a VF bed, then the nitrate can be removed by biological denitrification in an HF bed, which will be more oxygen stressed than the VF bed. Therefore, if the process design is done [skillfully], the advantages and disadvantages of the two types of beds can be used in a complementary fashion,” (Cooper 18). Vymazal cites examples of both VF-HF series systems, and HF-VF series systems. Therefore, one of the main design considerations in wetland design is the properties of the constituents in the effluent from the fish hatchery. The pollutants targeted for removal will determine what types of flow need to be utilized.

Fish Hatchery Flow Constituents

The main pollutants targeted for treatment from agricultural flows are BOD₅, chemical oxygen demand (COD), TSS, Total nitrogen (TN), deionized ammonia (NH₄-N), and Total Phosphorous (TP) (Vymazal 7). Effluents from fish hatcheries differ from other types of runoff because they are very dilute, and contain a large amount of phosphorous (Vymazal 7). Phosphorous can cause eutrophication if introduced to receiving bodies of water, so the concentration of phosphorous after wetland treatment must be taken into consideration. Naylor, et al. presents a solution to the phosphorous issue: “...[T]he use of two sequential units is recommended, a first one consisting of a macrophyte planted basin using a neutral substrate to remove organic matter and N, followed by a second unplanted basin containing only a P-adsorbing substrate,” (Naylor 215). This could be considered if phosphorus becomes an issue in hatchery effluent.

To provide context a general idea of the concentrations of pollutants in fish farm effluents, Table 3 summarizes 1998 data from three fish farms in Virginia presented in Chapter 7 of a report by the US EPA entitled “Effluent Guidelines: Aquatic Animal Production Industry: Economic and Environmental Analysis Document”.

Table 3. Example Fish Farm Effluent Concentrations

Parameter	Farm 1 Effluent	Farm 2 Effluent	Farm 3 Effluent
Flow (MGD)	1.03-1.54	4.26-9.43	9.74-10.99
BOD ₅ (mg/L)	0.96-1.9	0.6-2.4	0.5-1.8
DO (mg/L)	5.7-9.5	6.8-9.6	7.2-9.4
pH	7.3-7.8	6.9	7.8
Temperature (°C)	11-15.5	5-16.5	8.5-14
TSS (mg/L)	0.8-6	1.5-7.5	4.1-62
Settleable Solids (mg/L)	0-0.04	0.01-0.08	0.04-0.08
NH ₃ -N (mg/L)	0.5-0.6	0.45	0.02-0.17
Dissolved Organic Carbon (mg/L)	1.5-2.4	1.2-3.1	1.5-3.8

Governing Equations and Design Considerations

The Technology Assessment (Assessment) conducted by the Environmental Protection Agency in July 1993 describes certain equations that can be used to estimate size for CW design purposes. Darcy’s Law has been used in practice to calculate either the flow rate into the CW or the cross-sectional area perpendicular to the flow:

Equation 2. Darcy’s Law (EPA Technology Assessment 4-3)

	$Q = k_s A S$	(2)
Where:	Q = flow per unit time, m ³ /d (ft ³ /d), or (gal/d), etc. k_s = hydraulic conductivity of a unit area of the medium perpendicular to the flow direction, m ³ / m ² / d (ft ³ /ft ² /d), or (gal/d), etc. A = total cross-sectional area, perpendicular to flow, m ² (ft ²). S = hydraulic gradient of the water surface in the flow system dh/dL, m/m, (ft/ft). (All units must be consistent)	

The Assessment provides the following analysis of using Darcy’s Law to approximate flow or shape: “Darcy’s Law is not strictly applicable to subsurface flow wetlands because of physical limitations in the actual system. It assumes laminar flow conditions, which may not be the case when large rock or very coarse gravel are used as the media. Turbulent flow will occur in these coarse media when the hydraulic design is based on a high hydraulic gradient. Darcy’s Law also assumes that the flow (Q) in the system is constant and uniform, but in the actual case in a SF wetland the input versus output Q may vary due to precipitation, evaporation, and seepage; and short circuiting of flow may occur due to unequal porosity or poor construction. **[All] of these factors limit the theoretical applicability of Darcy’s Law, but it remains as the only reasonably accessible model for design of these SF systems,**” (EPA Technology Assessment 4-3).

To determine BOD₅ removal, the model of a first order plug flow reactor has been used, given by Equation 3.

Equation 3. First-order Plug Flow Model (EPA Technology Assessment 3-7)

$$\frac{C_e}{C_o} = e^{-K_T t}$$

Where:

- C_e = Effluent BOD₅ (mg/L)
- C_o = Influent BOD₅ (mg/L)
- K_T = temperature dependent rate constant (d⁻¹)
- t = hydraulic residence time (d)
- K_T = K₂₀(1.06)^(T-20)
- K₂₀ = rate constant at 20°C, (d⁻¹)
- = 1.104 d⁻¹
- T = temperature of liquid in the system (°C)

The surface area (length * width) can be calculated using Equation 4.

Equation 4. Surface Area to Achieve Needed BOD₅ Removal (EPA Technology Assessment 4-12)

$$A_s = (L)(W) = \frac{Q[\ln(C_o/C_e)]}{K_T dn}$$

Where:

- A_s = bed surface area, m²(ft²)
- Other terms defined previously

For an in-depth discussion of aspect ratio, bed slope, media types, vegetation selection, and inlet and outlet structures, see the EPA’s Technology Assessment.

The design process for BOD₅ removal given by the EPA is as follows:

1. Determine the media type, vegetation, and depth of bed to be used.
2. Determine by field or laboratory testing the porosity (n) and “effective” hydraulic conductivity (k_s) of the media to be used.
3. Determine the required surface area of the bed, for the desired level of BOD₅ removal [with equation 4]
4. Depending on site topography, select a preliminary aspect ratio (L:W); 0.4:1 up to 3: 1 are generally acceptable.
5. Determine bed length (L) and width (W) from the previously assumed aspect ratio, and results of step 2.
6. Using Darcy’s Law [equation 2] with the previously recommended limits (k_s < 1/3 “effective” value, hydraulic gradient S < 10% of maximum potential), determine the flow (Q) which can pass through the

bed in a subsurface mode. If this Q is less than the actual design flow, then surface flow is possible. In that case it is necessary to adjust the L and W values until the Darcy's Q is equal to the design flow.

7. It is not valid to use [equation 2] with effluent BOD₅ (C_e) values below 5 mg/l. As previously discussed, these wetland systems export a BOD₅ residual due to decomposition of the natural organic detritus in the system.
8. In cold climates it is necessary to assume a design temperature for BOD₅ to first determine the required surface area. Thermal calculations are then necessary to determine the winter heat losses and bed temperature conditions during the design HRT. Further iterations of this procedure are necessary until the assumed temperature and the temperature determined by the heat loss calculations converge.
 (EPA Technology Assessment 4-13)

For a more detailed discussion of the caveats of using the above design steps, see the EPA's Technology Assessment by Sherwood C. Reed, cited in Works Cited.

Sample Calculation

Below is a sample design calculation for a subsurface flow constructed wetland. Table 4 lists the values used in the sample calculation.

Table 4. Values Used in Sample Calculation

Characteristic	Value	Source
Flow Rate, Q (gpm; MGD)	1,000; 1.44	Assumed
Media Type	Medium gravel	Chosen from EPA Table 5 (4-6)
Porosity, n (%)	40	Table 5
Effective Hydraulic Conductivity, k _s (m ³ /m ² d)	10,000	Table 5
Vegetation Type	Reeds, <i>Phragmites</i>	Chosen from EPA Table 6 (4-12)
Root Depth (m)	0.6	Table 6
Bed Depth (ft)	3.0	Estimated
Aspect Ratio, L:W	0.4:1	Estimated
Water Surface Hydraulic Gradient, S (ft/ft)	0.01	Estimated
BOD ₅ of Influent, C _o (mg/L)	10	Estimated
BOD ₅ of Effluent, C _e (mg/L)	5	Estimated
Average Depth of Liquid in Bed, d (ft)	2.5	Estimated
Temperature of Fluid in System, T (°C)	10	Estimated
Rate Constant at 20°C, K ₂₀ (d ⁻¹)	1.104	EPA Tech Assessment (4-11)

- a. Calculate K_T value, rate constant at temperature T:

$$K_T = K_{20} * (1.06)^{(T-20)}$$

$$K_T = (1.104) * (1.06)^{(10-20)}$$

$$K_T = 0.616 \text{ d}^{-1}$$

- b. Calculate the bed surface area, A_s:

$$A_s = L * W = (Q * [\ln(C_o/C_e)]) / (K_T * d * n)$$

$$A_s = 216,444.84 \text{ ft}^2 \text{ for a 50\% BOD}_5 \text{ reduction} \approx 5.0 \text{ acres}$$

- c. Calculate L and W using A_s and chosen aspect ratio:

$$L:W = 0.4:1 \text{ (from Table 2)}$$

$$0.4x^2 = A_s$$

$$x = 735.60 \text{ ft}$$

- d. Check theoretical flow, Q_o against assumed flow, Q using Darcy's Equation:

$$Q_o = (1/3) * k_s * A * S \text{ with } A = W * d$$

$$Q_o = 1044.76 \text{ gpm}$$

Check: $Q_o > Q$, flow will be below the surface

Note: if an S value of 0.001 is used, then $Q_o = 104.48 \text{ gpm}$, which makes $Q_o < Q$, and surface flow is very likely to occur. Adjust inputs, such as d, S, and L:W to ensure that $Q_o > Q$ in the final design.

- e. Calculate the hydraulic residence time factor, t, from plug flow model:

$$t = (n * L * W * d) / Q$$

$$t = (0.4 * A_s * 2.5) / Q$$

$$t = 1.12 \text{ days}$$

- f. Final wetland dimensions:

$$A_s = 216,444.84 \text{ ft}^2 \approx 5.0 \text{ acres}$$

$$L = 294.24 \text{ ft}$$

$$W = 735.60 \text{ ft}$$

Conceptual Wetland Sizing for Big Bear Hatchery

The flow rate required through the wetland will depend on the recirculation rate to the hatchery and amount of makeup water used. For this analysis, it was assumed that 50% of the 3,000 gpm flow would be recirculated in the hatchery, requiring 1,500 gpm from the wetlands. Table 5 shows the values used to estimate the size for treatment wetlands.

Table 5. Values Used in Big Bear Calculation

Characteristic	Value
Flow Rate, Q (gpm)	1,500
Bed Depth (ft)	3.0
Aspect Ratio, L:W	0.52:1
BOD ₅ of Influent, C _o (mg/L)	15
BOD ₅ of Effluent, C _e (mg/L)	5
Average Depth of Liquid in Bed, d (ft)	2.5
Temperature of Fluid in System, T (°F)	50

A first order plug flow reactor model with maintenance of subsurface flow using Darcy’s Law was used to estimate wetland size. Based on an assumed 3 day hydraulic retention time (HRT) for full NDN, 18 to 24 acres of land would be required for this wetland, as shown in Figure 6. Note that this wetland could require flood protection.



Figure 6. Conceptual Wetland Size

Potential Refinements

Alternative Treatment Options

In addition to a wetlands treatment concept, an alternative treatment option was identified.

A package wastewater treatment plant could be installed instead of a wetlands treatment system. This would include the following:

1. Headworks
 - a. 1,500 gpm fine screen (50 micron or less)
 - b. pH correction/nutrient addition if required
 - c. Flow meter and flow control box
2. Treatment
 - a. 3 trickling filter trains each capable of receiving 500 gpm
 - b. Each train will have a recirculation pump, distribution header, air supply system etc.
3. Effluent Screening
 - a. Final effluent will be screened prior to disposal to a polishing pond and back to the hatchery

Community Benefits

In addition to the recreational benefits that a local hatchery would provide, the following list provides a few ideas for additional elements could be incorporated to provide added community benefits:

- university research opportunities
- interactive community component that provides public tours and education for the hatchery
- interactive community component that provides public tours and education for the wetlands treatment system

Opinion of Preliminary Cost

A concept level opinion of preliminary cost was developed to provide an order of magnitude estimate for the hatchery and wetlands treatment concept to help guide decisions on next steps for this project component.

It is estimated the hatchery would cost between \$8.3M and \$13.2M, and the wetlands would cost between \$8.0M and \$11.3M, not including the cost of the plants. This gives a total of between \$16.3M and \$24.5M. An alternative mechanical treatment plant could cost between \$6.2M and \$7.5M. These costs include implementation and contingency allowance and conservative and intended for an order of magnitude analysis. Annual operating costs could be between \$400,000 and \$700,000, based on FTE per CDFW hatcheries and CDFW hatchery budgets.

Using an annualized cost method and assuming the capital costs are financed with a 30-year loan at 2.2% (to be consistent with the financial assumptions for the other components in the Recycled Water Facilities Planning Study), the unit cost of the fish produced would be in the range of \$8 to \$12 per pound.

Next Steps

The key assumptions, unknowns, and potential next steps are outlined below.

Key Assumptions and Unknowns

- A pilot study is required to understand nitrogen removal and water quality
- Evapotranspiration has not been accounted for in either the raceways or in the wetlands
 - Makeup water is available from the BBARWA WWTP
- Increased solids handling from cleaning of hatchery raceways could impact the WWTP
- Unionized ammonia ratio needs more research
 - Impacted by alkalinity, pH, temperature of water, and actual gravel source
- A pilot study is needed to assess the ability of a subsurface wetland to consistently reduce ammonia below 1 mg/L
- HRT of ~3 days to meet ammonia target
 - A reduction in HRT would reduce wetland size

Potential Next Steps

- Visits to Mojave River Hatchery
- Prepare bio-programming and hatchery feasibility study by hatchery expert
- Study feasibility of wetlands treatment for hatchery recirculation
- Investigate regulatory considerations
 - EPA, USDA, CDFW, RWQCB, etc.
- Pilot study with small-scale wetland and hatchery

Works Cited

5. *Water Quality: Ammonia*. Ed. The University of Tennessee Knoxville. n.d.
<<http://web.utk.edu/~rstrange/wfs556/html-content/05-ammonia.html>>.
- Cooper, Paul. "What Can We Learn from Old Wetlands? Lessons That Have Been Learned and Some That May Have Been Forgotten over the past 20 Years." *Desalination* 246.1-3 (2009): 11-26. Elsevier. Web.
- Naylor, S., J. Brisson, M.A. Labelle, A. Drizo, and Y. Comeau. "Treatment of Freshwater Fish Farm Effluent Using Constructed Wetlands: The Role of Plants and Substrate." *Water Science & Technology* 48.5 (2003): 215-222. *Google Scholar*. Web. 3 Nov. 2015.
- Shelton, James L. *Aquaculture Technical Series: Trout Production*. Athens: Cooperative Extension Service, The University of Georgia College of Agricultural and Environmental Sciences and the United States Department of Agriculture, n.d.
- United States of America. EPA. Washington, DC. *Effluent Guidelines: Aquatic Animal Production Industry: Economic and Environmental Analysis Document*. EPA, June 2004. Web. 3 Nov. 2015.
<http://water.epa.gov/scitech/wastetech/guide/aquaculture/EEBA_index.cfm>.
- United States of America. EPA. Office Of Water. *Subsurface Flow Constructed Wetlands for Wastewater Treatment: A Technology Assessment*. By Sherwood C. Reed. Washington, D.C.: United States Environmental Protection Agency, Office of Water, 1993. Print.
- Vymazal, J. "The Use Constructed Wetlands with Horizontal Sub-surface Flow for Various Types of Wastewater." *Ecological Engineering* 35.1 (2009): 1-17. Web.

Appendix J. Fort Erwin Tank Cost Evaluation Memorandum

Memorandum



Date: 2/27/2015

To: Reggie Lamson
Big Bear Lake Department of Water and Power
41972 Garstin Dr
Big Bear Lake, CA 92315

Phone: (909) 866-5050

Prepared by: Christy Stevens, PE and Kaylie Ashton, EIT

Reviewed by: Josh Reynolds, PE

SUBJECT: COST ESTIMATE FOR BBARWA TANK COST

Big Bear Lake Department of Water and Power (BBLDWP) asked Water Systems Consulting, Inc (WSC) to prepare a comparative cost opinion for construction of a 500,000 gallon modular precast concrete tank supplied by the U.S. Army Corps of Engineers (COE) and a custom cast-in place concrete tank. The COE has offered a 100' x 50' x 20' precast concrete tank (nominally 500,000 gallons storage) for use by BBLDWP/ Big Bear Area Regional Wastewater Agency (BBARWA). The tank panels are currently stored at the manufacturer's yard (Structure Cast) in Bakersfield. The precast tank will be stored at BBARWA's site until it is installed. WSC also prepared a cost opinion for a more traditional cast-in-place concrete tank in order to compare the relative value of accepting the modular precast tank from COE.

Precast Concrete Tank

The precast concrete tank has been designed and fabricated by Structure Cast to the COE project specifications. The modular tank is composed of 80 precast concrete panels as follows:

1. Thirty (30) 10' x 20' exterior wall panels
2. Twelve (12) 8.5' x 20' interior wall panels
3. Thirty-eight (38) roof panels with variable dimensions

The tank will be partially buried up to a depth of 10' and will be fabricated on a cast-in-place concrete slab foundation. Fabrication requires placing the wall panels onto rebar dowels cast into the foundation followed by installation of 1" diameter steel horizontal tie-rods which are post tensioned to pull the panels together. The tank is waterproofed with a combination of joint mastic, grout, and waterproof caulking at locations where the panels join each other or the foundation. The roof panels are set on rebar cast into the wall panels, protruding approximately 30" from the end of the wall panel which aligns with sleeves cast into the roof panels.

Work involved includes the following items:

1. Delivery and storage of the panels until ready for use
2. Design and construction of a concrete slab foundation
3. Excavation and backfill of the tank
4. Fabrication and testing of the tank

The comparative cost does not include site piping, level sensing, valves, hatches, ladders, or other work that would be comparable between the two tank options and will depend on the final selected use and layout of the tank and project site.

Precast Concrete Tank	
Work Item	Cost (\$)
Delivery from Bakersfield to BVWSP ¹	197,000
Delivery Credit from COE ¹	(197,000)
Storage materials	5,000
Installation	
Construct concrete foundation	175,000
Excavation & backfill for half buried tank ²	110,000
Fabricate and test tank	220,000
Subtotal	510,000
Confirm structural design of tank for new location ³	5,000
Design foundation - structural and geotechnical engineering	24,000
Construction management	25,000
Subtotal	564,000
20% Contingency	113,000
Comparative Project Total	677,000
¹ WSC understands that the COE will over the cost of delivery to Big Bear Lake assuming the actual delivered cost is less than the budgeted delivery line item in the Fort Irwin Hospital project bid of \$535,000. ² Excavation & backfill of completely buried tank is estimated at an additional \$70,000. ³ Structural evaluation of tank should be completed prior to accepting delivery of the tank.	

Cast-in-place Concrete Tank

As a point of comparison, BBLDWP requested a cost opinion for an equivalent cast-in-place concrete tank. The cast-in-place tank would have similar dimensions to the precast tank (100' x 50' x 20'). The cast-in-place concrete tank is anticipated to be a traditional steel reinforced concrete tank, comprised of a poured reinforced concrete foundation slab with reinforced walls formed and poured in place on the foundation. This option will require complete design engineering, and will be delivered by the traditional design-bid-build contract method.

Cast-in Place Concrete Tank	
Work Item	Cost (\$)
Construct concrete foundation	175,000
Excavation and backfill for half buried tank	110,000
Cast-in-place walls	310,000
Pre-fabricated roof system	125,000
Subtotal	710,000
Design (includes structural, geotechnical and civil engineering)	80,000
Construction management, materials testing, office engineering	85,000
Subtotal	875,000
20% Contingency	175,000
Comparative Project Total	1,050,000

Comparison

Comparing the two project totals the precast tank is less expensive to implement with a potential savings to BBLDWP in excess of \$300,000. However, this cost savings has some potential risk associated with it. The risk should be considered to increase the effective cost of the precast tank. Here are a few of the areas of concern with the precast tank:

1. The precast concrete panels have exposed steel rebar and cast sleeves that could be subject to corrosion when stored for an extended period outdoors. The corrosion, if not inhibited, could decrease the useful life of the tank. Mitigation could include coating the rebar prior to storing, and/or cleaning rust from steel prior to fabrication.
2. The tank requires long steel rods to tension the panels together, which requires alignment of the sleeves in the panels. There is +/- 1" of tolerance on the alignment of the sleeves. However, if the tank sits for an extended period it may be costly to correct any misalignment inherent in the panels. There may not be a contractual/binding obligation back to StructureCast in the future.
3. The tank design requires extensive water sealing of tank panel joints. The joints could be a potential source of leaks. If the tank doesn't pass testing for leaks and water tightness it could result in a protracted fight with the fabricator regarding the source of the leaks/defects (i.e. contractor, manufacturer, or storage defects).
4. Panels, sleeves, or rebar could be damaged during storage leading to installation/tank fabrication issues. This could require re-casting panels.
5. The design of the panels may restrict coring openings for new pipe penetrations in the interior and exterior panels to accommodate the required pipe connections and to create openings between the three storage bays. If adequate openings cannot be cored, new panels would need to be cast.

Appendix L. Question & Answer Letter



8/30/2016

Steve Schindler
Big Bear Area Regional Wastewater Agency
121 Palomino Drive
Big Bear City, CA 92314

SUBJECT: RESPONSES TO QUESTIONS ON THE DRAFT BEAR VALLEY WATER SUSTAINABILITY PROJECT REPORT

Dear Steve,

This letter presents a summary of questions and comments received from the BBARWA Board of Directors following their review of the Draft Bear Valley Water Sustainability Project Report (Report), along with responses.

1. Can secondary effluent and/or tertiary water be utilized for snowmaking at the local resort?

Yes, the State Water Resources Control Board (State Water Board) permits the use of disinfected tertiary recycled water for artificial snowmaking purposes. In late 2015, Donner Summit Public Utilities District partnered with Soda Springs Mountain Resort to become the first ski area in California to make snow using recycled water.

This beneficial use alternative was considered as a potential refinement to Alternative 3, as described in Section 5.1.3.6 of report. Key challenges to implementation of this beneficial use in Big Bear include potential negative public perception, the cost of the recycled water, and the additional operational considerations for the Bear Mountain Resorts; therefore, it was concluded that the use of recycled water for artificial snowmaking in Big Bear is not a highly favorable opportunity. Despite these challenges, if the Big Bear Valley agencies would like to further evaluate this opportunity, the next step would be to meet with the resort owners to discuss the potential project and gauge their interest in using recycled water for snowmaking.

Potential public perception issues can be evaluated with public surveys and addressed through focused community outreach. The cost of delivering recycled water for snowmaking could be reduced if the existing pipeline running from Lake Pump Station to Big Bear Mountain Resorts, which is currently used to deliver water for firefighting and snowmaking, was used to distribute the recycled water. Regulatory and operational considerations for shared use of the pipeline would need to be evaluated. Also, the amount of water used for snow making is minimal and seasonal, which adds to this not being a viable option.

2. Can we "over" irrigate a crop within the Valley and utilize the incidental percolation concept to achieve recharge?

No, the State Water Board strictly regulates irrigation sites that use recycled water and requires that recycled water application is limited to rates required to grow the crop to minimize the potential for runoff, ponding, and incidental percolation. Regional Boards are becoming more active in enforcing this restriction. BBARWA's Waste Discharge Requirements (WDR) permit for the Lucerne Valley

irrigation site was recently updated by the Colorado River Regional Board to require an Irrigation Management Plan that includes a water balance and nutrient balance to assure that recycled water is applied at appropriate rates.

3. *What is the feasibility of using reclaimed water for release to Bear Creek?*

Bear Creek is designated as a Municipal and Domestic Water Supply in the Santa Ana River Basin Plan (Basin Plan); therefore, discharge to Bear Creek may be regulated as a potable reuse project, which would require advanced treatment. Discharge to Bear Creek under a potable reuse scheme would require an analysis to demonstrate that there would be sufficient environmental buffer before downstream water purveyors divert the water to their surface water treatment facilities. The potential negative public perceptions from the downstream users would be a key challenge to this scenario. If the Department of Drinking Water determined that the discharge to Bear Creek was not a potable reuse project, it may be possible to discharge tertiary treated recycled water to Bear Creek. However, the Basin Plan Water Quality Objective for total dissolved solids (TDS) for Bear Creek is 175 mg/L, so the recycled water would require treatment with reverse osmosis (RO) to reduce salts, increasing the cost of producing the recycled water. The pipeline from the BBARWA WWTP to Bear Creek would be approximately 12.5 miles in length and cost approximately \$20 million to construct.

State Water Board Order No. 95-4 mandates a minimum flow to be released from the lake to maintain a minimum average daily flow of 1.0 cfs in Bear Creek to provide fishery protection. Potential effects to the fish and their habitat would need to be evaluated to ensure the recycled water release to Bear Creek would not result in habitat degradation.

Although this option may provide an alternative to releases from the lake, it does not provide a water supply benefit to the Big Bear Valley.

4. *What is the feasibility of implementing a small reclamation effort to get our foot in the door while planning for future expansion?*

One potential option for implementing a small reclamation effort to initiate the Bear Valley Water Sustainability Project is to construct a small-scale advanced treatment unit at the BBARWA WWTP and recharge the purified water at the Greenspot recharge site. Prior reports have demonstrated that permitting and constructing the Greenspot site for groundwater recharge is feasible. A skid-mounted advanced treatment facility could be installed at BBARWA's WWTP and tanker trucks can haul a small portion of recycled water to a demonstration recharge basin at the Greenspot site. Deferring the construction of the pipeline to the Greenspot site would reduce the initial capital investment by approximately \$5 million.

Although the unit cost of small scale projects is high due to economies of scale, a small demonstration project provides opportunities for community education, proof of concept and local buy-in of the project. The small-scale project would allow the Big Bear Agencies to minimize risk of implementing a large recycled water program and reduce the initial capital expenditure necessary to initiate the program. WSC can perform a cost analysis of this alternative and include the results and a general description of the project in the Final Draft of the Report.

To make a small reclamation effort more financially feasible for the Big Bear Valley, BBARWA can pursue low interest loans or grants to help fund a recycled water program. It is common for funding agencies to solicit applications for small recycled water demonstration projects that provide habitat enhancement, social benefits, water supply benefits or educational opportunities. For example, the United States Bureau of Reclamation (USBR) recently began a Drought Response Program to fund Contingency Planning and Drought Resiliency Projects aimed at building long-term resiliency to drought. The conditions of the Drought Response Program closely align with the objective of the Bear Valley Water Sustainability Project; therefore, if the USBR Drought Response Program receives federal funding allocations for the next fiscal year, the program can be evaluated in early 2017 as a potential funding source.

5. *What is the feasibility of establishing a coalition consisting of Federal, State, County, City, CSD, DWP, MWD, BBARWA and the MWA to fund a reclamation effort?*

BBARWA, DWP, CSD and MWD have demonstrated their commitment to working together toward common benefits by partnering to develop this Report as a first step. There is an opportunity for elected representatives of these agencies to foster relationships with other elected officials to develop further support and collaborative teaming agreements to further advance a reclamation effort in the Big Bear Valley. Each agency would likely need to gain a clear understanding of the short and long term benefits to their citizens to justify a shared funding effort.

Competitive Federal and State funding programs solicit grant and low-interest loan funding for recycled water projects, and sometimes provide opportunities to combine both Federal and State funding sources to further benefit the community.

6. *The capital cost of a Brine Management System is \$9,742,000 and the O&M cost is \$1,018,000 or about 40% of the total annual O&M? Please provide additional details regarding components of this cost.*

The brine management system component of this Report was developed based on the findings from the CH2M and BBARWA report, *Evaluating Traditional and Innovative Concentrate Treatment and Disposal Methods for Water Recycling at Big Bear Valley, California*, completed in 2007. This study evaluated seven alternative technologies based on detailed site-specific considerations and pilot testing of some equipment. The study identified the most favorable alternative as a system consisting of a vibratory shear enhanced process (VSEP) to reduce brine volume, a blending system, a small pipeline inside the existing Lucerne Valley discharge pipeline, and new evaporation ponds in the Lucerne Valley. The 2007 study provided only total capital and O&M costs and did not provide a breakdown of costs by component. These total values were escalated to 2015 costs and scaled to match the flows used in the Report.

Due to the significant cost of brine management, one of the recommended next steps in development of a Bear Valley Water Sustainability Project is to target optimization of brine management at the existing BBARWA WWTP by evaluating:

- new and emerging technologies since the 2007 study that could reduce brine disposal costs
- local brine evaporation scenarios and sites
- alternative treatment technologies for a portion of the advanced treatment to minimize brine produced

7. *Is the useful life of equipment in this Report assumed to be 20 years? Except for pipelines, is that reasonable?*

The useful life of equipment assumed for this Report was 20 years, except pipelines, which are designed for a useful life of 60 years or more. A useful life of 20 years for the equipment is a conservative assumption. BBARWA staff has practiced an aggressive preventive maintenance schedule to maximize the useful life of the equipment and mitigate equipment failures. For example, the bar screens at the wastewater treatment plant were installed in 1974 with an expected useful life of 15 years, but preventative maintenance activities enabled the bar screens to operate until 1993 before a major overhaul was performed. The bar screens are still in operation and have far exceeded their expected useful life of 15 years due to BBARWA's preventative maintenance practices.

8. *Is it possible to arrange a tour of Orange County's Groundwater Replenishment System?*

Yes, the Orange County Water District frequently offers tours of their facility. WSC would be glad to coordinate with Orange County Water District to schedule a tour for the agencies that participated in this study.

9. *What is the possibility of using Big Bear Lake water to help with the 20-80% blend for groundwater recharge dilution credits?*

The Groundwater Recharge Regulations require the diluent water source to meet drinking water standards for primary and secondary Maximum Contaminant Levels (MCLs) and notification levels. As a surface water, the existing lake water quality would not meet these drinking water standards and would require additional treatment through a surface water treatment plant.

10. *Is it correct that tertiary treated water cannot be used to augment the water supply in Big Bear Lake?*

Disinfected tertiary recycled water could potentially be used to augment the lake levels in Big Bear Lake; however, there are currently restrictions in place that prohibit that practice. Currently, BBARWA operates under a Waste Discharge Requirement (WDR), which does not permit discharge to waters of the United States (i.e., Big Bear Lake). To enable this practice, the WDR would need to be changed to a National Pollutant Discharge Elimination System (NPDES) permit which would impose stricter discharge limits on the wastewater treatment plant effluent stream. Additionally, MWD has a resolution in place that prohibits discharge of recycled water to Big Bear Lake. This resolution would need to be rescinded by MWD to enable this practice.

Based on discussions with regulatory agencies, using disinfected tertiary recycled water to augment the lake levels is possible, provided the necessary permits and resolutions are changed and sufficient technical analysis is performed. The analysis would have to demonstrate that the introduction of recycled water to Big Bear Lake would not degrade the water quality of the lake. The Basin Plan Water Quality Objectives for Big Bear Lake are very low for nitrogen, phosphorus, and TDS. In addition to tertiary treatment upgrades, RO treatment would need to be added to reduce the salt in the recycled water to meet the lake TDS objective of 175 mg/l.

Public perception could be a significant barrier to implementation of this practice and would need to be addressed through a community outreach program.

11. Would a lower cost alternative be to put RO treated recycled water into Big Bear Lake?

Yes, an alternative that delivers RO treated recycled water to the lake would have a lower cost than those presented in the report due to a lower level of treatment and a shorter pipeline. This option was not evaluated in the report because it was not found to provide a water supply benefit to the Big Bear Valley, which is a key objective of the report. Without a water supply benefit, opportunities for grants and low-interest loans would be very limited and would place more of the financial responsibility on the local community.

However, based on discussions with regulators, this is expected to be a feasible option to augment lake levels. One risk to this use of recycled water is that it may create a long term water dependency and make it difficult to change the discharge point in the future, due to political and/or environmental challenges. For example, if a water supply benefit becomes more critical and the agencies decide to transition to groundwater recharge, there could be opposition to removing the water from the lake by the community or environmental groups if the water has supported habitat in the Stanfield Marsh.

12. Is it feasible to provide RO treated recycled water to discharge to Stanfield Marsh or Baldwin Lake?

Prior studies of groundwater recharge potential in the Big Bear Valley have not identified Stanfield Marsh or Baldwin Lake as viable locations for groundwater recharge. In previous reports, it was concluded that Stanfield Marsh would not be conducive to percolation due to an underlying clay layer and would not provide a water supply benefit. Additionally, since the Stanfield Marsh is hydraulically connected to the Lake, the TDS objective for Stanfield Marsh would be the same as the Lake, which is 175 mg/L. Treating to this TDS level would require a significant portion of the discharge to receive RO treatment to reduce TDS.

13. What is the feasibility of developing an initial project to include tertiary treated recycled water for irrigation and construction purposes?

The report evaluated numerous pipe segments and customer groups for providing recycled water for irrigation and construction. Of these, Segment 1.1, which provides irrigation water for schools and parks in Sugarloaf, is the lowest cost segment. The total capital cost would be \$3.3 million to serve approximately 54 AFY of recycled water. This system is a standalone system due to the higher elevation in Sugarloaf so it can be implemented independent of all other options. As a result, it would not be expandable in the future to serve additional customer or integrate with a groundwater recharge project. Although the initial capital investment for this segment would be lower, the unit cost is nearly \$4,000/AF and it does not build a foundation that can be expanded upon for future reuse projects.

14. The Report should address "gray water." I believe the County actually has a gray water ordinance, but I do not think many are aware of it.

The Report will be edited to address gray water in Section 6.4, Water Conservation / Reduction Analysis. Implementation of private gray water systems would decrease wastewater generation, as

well as water consumption. While gray water systems provide an opportunity to increase the sustainable use of resources, widespread implementation in the Big Bear Valley would have an impact on the volume and strength of wastewater available for future reuse projects.

15. *Comment on digging deeper into Point of Use (POU) conservation measures other than the easy ones (toilets and low flow fixtures).*

Section 6.4 of the Report, which discussed Water Conservation / Reduction Analysis will be edited to include an expanded discussion of current and proposed conservation measures being implemented by the DWP and CSD. Additional water conservation would have an impact on the volume and strength of wastewater available for future reuse projects.

16. *Look at what other arid communities/countries (Israel) do.*

The development of water reuse in the United States has been greatly influenced by the research, experiences and treatment technologies employed in arid countries who have been pioneers in water reuse, including Israel, Singapore, and Australia. In the United States, the WaterReuse Association has partnered with agencies in Singapore and Australia to share expertise and knowledge to benefit the research community and the water industry as a whole. Through conferences, research projects, and toolsets, the WaterReuse Association provides its members with the newest ideas, information, and tools for evaluating and implementing water reuse projects. As an active member of the WaterReuse Association, WSC regularly utilizes these state-of-the-industry resources and leveraged this information as appropriate in the development and evaluation of water reuse alternatives in the Big Bear Valley.

Please don't hesitate to reach out with any additional questions or if clarification is required for any responses contained in this letter.

Sincerely,

Water Systems Consulting, Inc.



Laine E. Carlson, PE
Project Manager